

BODY PANEL MOULDING CLIPS

	PAGE
AMERICAN MOTORS CLIPS & RETAINERS	246
CHRYSLER CLIPS & RETAINERS	
BELT, REVEAL, ROOF & VINYL TOP	225
BUMPER, LIGHTS & TRUNK	240
DOOR, QUARTER, ROCKER & DECK LID	228
FENDER & WHEEL OPENING	226
GARNISH, HEADLINER & INTERIOR	235
GRILLE, COWL & SPLASH SHIELD	236
FORD CLIPS & RETAINERS	
BELT, REVEAL, ROOF & VINYL TOP	200
BUMPER, LIGHTS & TRUNK	219
DOOR, QUARTER, ROCKER & DECK LID	204
FENDER & WHEEL OPENING	201
GARNISH, HEADLINER & INTERIOR	211
GRILLE, COWL & SPLASH SHIELD	214
PROBE CLIPS	209
GENERAL MOTORS CLIPS & RETAINERS	
BELT, REVEAL, ROOF & VINYL TOP	152
BUMPER, LIGHTS & TRUNK	190
COWL VENT	187
DOOR, QUARTER, ROCKER & DECK LID	162
FENDER & WHEEL OPENING	157
FIERO CLIPS	177
GARNISH, HEADLINER & INTERIOR	178
GEO	176
GRILLE, COWL & SPLASH SHIELD	182
PONTIAC LeMANS	176
SATURN	174
UNIVERSAL/TRUCK CLIPS & RETAINERS	247

BELT REVEAL ROOF & VINYL TOP MOULDING



96-7615
 Replaces: 9838109
CLIP- DOOR
 Door & Body Side Moulding
 Plastic, Formerly 74-3955
 G.M. '71
UNIT PACKAGE 25



74-3965
 Replaces: 7669866
CLIP-BELT REVEAL MOULDING
 Rear Window w/Vinyl Top
 All G.M. Cars '67/
UNIT PACKAGE 100

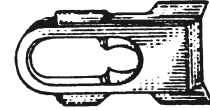

92-7092
 Replaces: 8799350
CLIP-BELT MOULDING
 Plastic
 Chevrolet, Olds, Buick
 & Pontiac '70/
UNIT PACKAGE 50

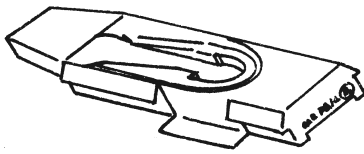

97-7674
 Replaces: 15554088
CLIP- ROOF MOULDING
 Plastic
 G.M. "C", "K" Trucks '88/
UNIT PACKAGE 50



72-3719
 Replaces: 9835259
CLIP-DOOR BELT REVEAL MOULDING
 8 - 32 Screw Size
 Chevrolet & G.M. Cars '71/
UNIT PACKAGE 50



74-3951
 Replaces: 9658424
CLIP-BELT REVEAL MOULDING
 All Cars w/Vinyl Top or
 Two Tone Paint
 G.M. Cars '73/
UNIT PACKAGE 100



77-4703
 Replaces: 1747001
CLIP-QUARTER BELT REVEAL MOULDING
 G.M. '74/
UNIT PACKAGE 100

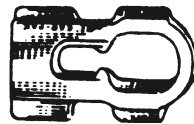

76-4264
 Replaces: 1660123
CLIP-BELT MOULDING
 G.M. Cars '75/
UNIT PACKAGE 100



75-4196
 Replaces: 1688094
CLIP-BELT REVEAL MOULDING
 Cadillac '75/
UNIT PACKAGE 50



75-4185
 Replaces: 1704850
CLIP-QUARTER BELT REVEAL MOULDING
 G.M. '76
UNIT PACKAGE 50



76-4291
 Replaces: 3062615
CLIP-QUARTER BELT REVEAL MOULDING
 G.M. '76/
UNIT PACKAGE 100

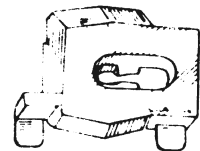

78-4758
 Replaces: 20036725
CLIP-REAR BELT REVEAL MOULDING
 2-Door
 Pontiac '77/
UNIT PACKAGE 50

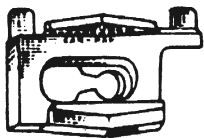

76-4362
 Replaces: 20030975
CLIP-REAR QUARTER BELT REVEAL MOULDING
 G.M. '77/
UNIT PACKAGE 50



76-4431
 Replaces: 20056133
CLIP-QUARTER BELT REVEAL MOULDING, OUTER
 G.M. '77/
UNIT PACKAGE 100

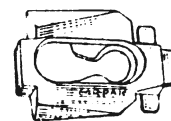

80-5177
 Replaces: 20071874
CLIP-REAR BELT REVEAL MOULDING
 (Used on Vinyl Tops)
 G.M. '78/
UNIT PACKAGE 50



77-4635
 Replaces: 20056133
CLIP-QUARTER BELT REVEAL MOULDING, OUTER
 G.M. '78/
UNIT PACKAGE 100

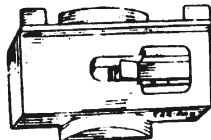

77-4590
 Replaces: 20068250
CLIP-QUARTER BELT REVEAL MOULDING
 G.M. '78/
UNIT PACKAGE 50

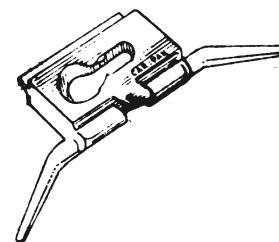

78-4742
 Replaces: 20093583
CLIP-QUARTER BELT REVEAL MOULDING
 G.M. Cars '78/
UNIT PACKAGE 100

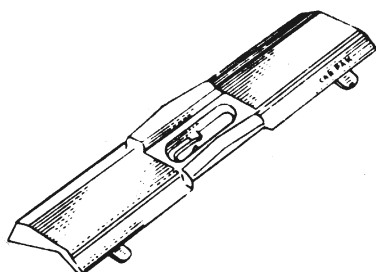

78-4952
 Replaces: 20109301
CLIP-BELT MOULDING
 G.M. '79/
UNIT PACKAGE 50

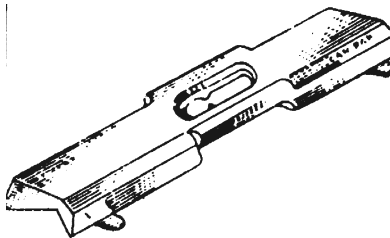

78-4965
 Replaces: 20093625
CLIP-QUARTER BELT REVEAL MOULDING
 Cars w/Vinyl Tops
 Buick Riviera '79/, Cadillac '79/
UNIT PACKAGE 50

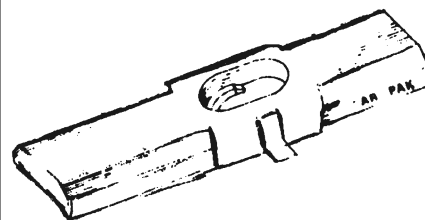

81-5289
 Replaces: 20175890
CLIP-BELT MOULDING
 G.M. '81/
UNIT PACKAGE 50

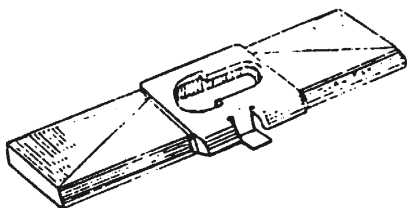

80-5233
 Replaces: 20237057
CLIP-BELT REVEAL MOULDING, REAR
 Cadillac '80/
UNIT PACKAGE 50



81-5306
 Replaces: 20199675
CLIP-BELT MOULDING
 G.M. '80/, "C" Body '85/
UNIT PACKAGE 100



80-5204
 Replaces: 20274997
CLIP-QUARTER BELT REVEAL MOULDING, REAR
 G.M. '81/
UNIT PACKAGE 100

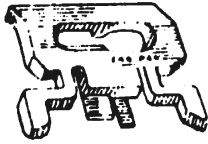

81-5459
Replaces: 20189061
CLIP-BELT MOULDING
G.M. '80/
UNIT PACKAGE 50



94-7314
Replaces: 20175051
CLIP-QUARTER BELT REVEAL MOULDING
Formerly 79-5089
Plastic
G.M. '80 - '90
UNIT PACKAGE 50



81-5311
Replaces: 1723088
CLIP-BELT MOULDING
G.M.
UNIT PACKAGE 50



83-5628
Replaces: 20184950
CLIP-REVEAL BELT MOULDING
FRONT & REAR
Chevrolet, Pontiac & Cadillac '82
UNIT PACKAGE 25

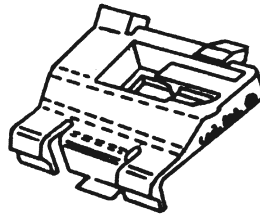

87-6189
Replaces: 20470354
CLIP-BELT REVEAL MOULDING, REAR
Plastic
Cadillac "C" Body (Fwd.) '85/
UNIT PACKAGE 25

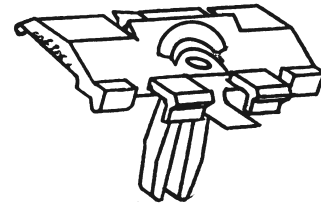

86-6168
Replaces: 20420558
RETAINER-BELT REVEAL MOULDING, REAR
Plastic
Cadillac "C" Body (Fwd.) '85/
UNIT PACKAGE 25

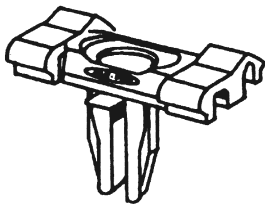

88-6437
Replaces: 22042557
RETAINER-ROOF BELT MOULDING, REAR
Plastic
G.M., Buick, Olds, "C" Bodies '85/
UNIT PACKAGE 50



88-6471
Replaces: 20693440
CLIP-QUARTER BELT MOULDING
Vinyl Roof
Plastic
G.M., Buick, Olds "H" Body '86/
UNIT PACKAGE 50

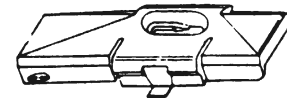

94-7227
Replaces: 20218415
CLIP-REAR END BELT REVEAL MOULDING
Plastic
Cars w/Vinyl Tops
Olds, Cutlass "G" Bodies '81 - '88
UNIT PACKAGE 15

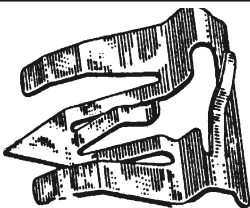

71-3461
Replaces: 9827569
CLIP-ROOF RAIL GARNISH MOULDING
All G.M. Cars '71 - '72
UNIT PACKAGE 25
J04536
UNIT PACKAGE 50

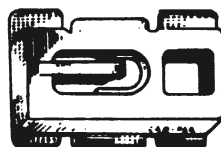

76-4371
Replaces: 20042718
CLIP-QUARTER WINDOW UPPER REVEAL MOULDING
G.M. '77/
UNIT PACKAGE 100

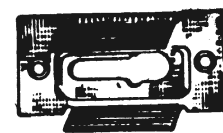

76-4358
Replaces: 20010898
CLIP-QUARTER WINDOW REVEAL MOULDING
G.M. '77/
UNIT PACKAGE 50

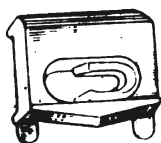

77-4589

Replaces: 20067021
CLIP-QUARTER WINDOW REVEAL
 MOULDING, FRONT
 G.M. Cars '78/
UNIT PACKAGE 100

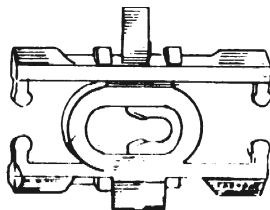

78-4943

Replaces: 20134575
CLIP-QUARTER WINDOW REVEAL
 MOULDING
 G.M. Cars '79/
UNIT PACKAGE 25

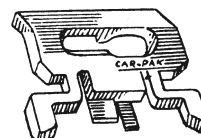

80-5171

Replaces: 20186851
CLIP-FRONT DOOR REVEAL
 MOULDING
 Buick '79/, Cadillac '80/
UNIT PACKAGE 50

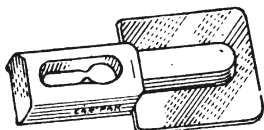

80-5172

Replaces: 20152999
CLIP-SIDE MOULDING ENDS
 (Prevents Sliding)
 G.M. '79/
UNIT PACKAGE 100

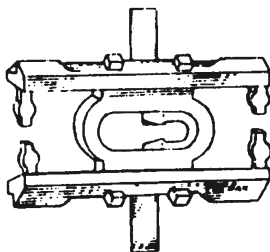

79-5064

Replaces: 20134574
CLIP-FINISH MOULDING ROOF
 PANEL COVER
 G.M. '80/
UNIT PACKAGE 25

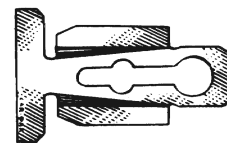

78-4939

Replaces: 20161379
CLIP-ROOF COVER FINISHING
 MOULDING, FRONT
 G.M. '79/
UNIT PACKAGE 50

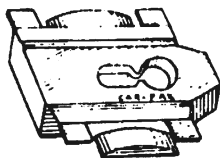

80-5201

Replaces: 20199337
CLIP-ROOF PANEL COVER FINISH
 MOULDING
 G.M. '81/
UNIT PACKAGE 50

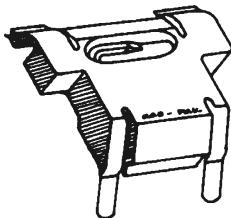

83-5627

Replaces: 20222445
CLIP-QUARTER WINDOW
 REVEAL MOULDING, LOWER
 G.M. '82
UNIT PACKAGE 25

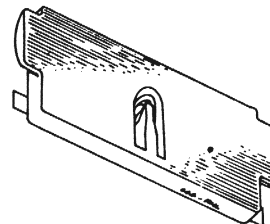

83-5632

Replaces: 20215548
CLIP-ROOF FINISH
 PANEL COVER
 Buick '82
UNIT PACKAGE 25

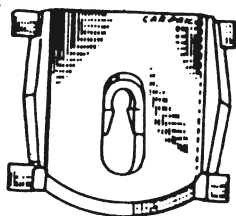

75-4181

Replaces: 1729250
CLIP-ROOF TRANSVERSE MOULDING
 G.M. '76/
UNIT PACKAGE 50

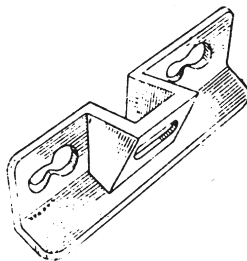

79-5012

Replaces: 20027800
CLIP-REAR WINDOW
 LOWER MOULDING
 Buick, Olds '77/
UNIT PACKAGE 25

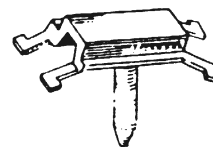

77-4596

Replaces: 1259297
REINER-HARD TOP
 MOULDING
 G.M. '78/
UNIT PACKAGE 25

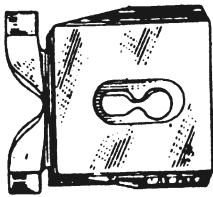
**77-4586**

Replaces: 3081072
CLIP-ROOF COVER
 Moulding, Front
 G.M. Cars '78/
UNIT PACKAGE 100

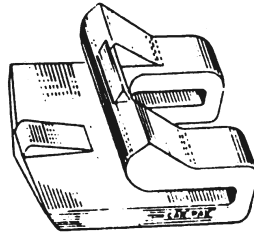
**77-4636**

Replaces: 3067084
CLIP-ROOF Moulding INNER SIDE,
 REAR
 G.M. '78/
UNIT PACKAGE 25

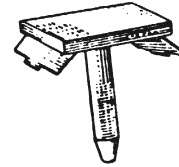
**79-5018**

Not Available From O.E.
RETAINER-SUNROOF Moulding
 G.M. etc.
UNIT PACKAGE 25

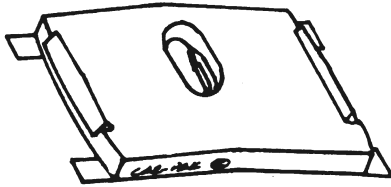
**87-6187**

Replaces: 20076165
CLIP-ROOF TRANSVERSE Moulding
 Plastic
 Buick Century & Regal '78 - '80
 Olds Cutlass '78 - '80
UNIT PACKAGE 25

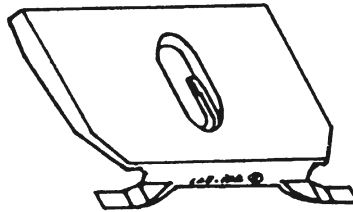
**87-6188**

Replaces: 20766166
CLIP-ROOF TRANSVERSE Moulding
 Plastic
 Buick Century & Regal '78 - '80
 Olds Cutlass '78 - '80
UNIT PACKAGE 25

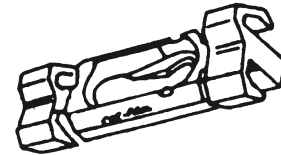
**90-6753**

Replaces: 20766166
CLIP-ROOF Moulding
 Plastic
 Cadillac Sedan DeVille '89/
UNIT PACKAGE 25

**91-6987**

Replaces: 10082288
RETAINER-FRONT DOOR WINDOW
 Moulding
 Plastic
 Cars w/Vinyl Tops
 G.M. Chevrolet Corsica '87/
UNIT PACKAGE 25

**74-4087**

Replaces: 9727078
CLIP-VINYL TOP Moulding
 ACROSS TOP OF ROOF
 Chevrolet, Olds,
 Cadillac '74 - '75
UNIT PACKAGE 50

**74-4089**

Replaces: 9698429
CLIP-VINYL TOP Moulding
 ACROSS TOP OF ROOF
 (Used on Wide Moulding)
 G.M. '75/
UNIT PACKAGE 50

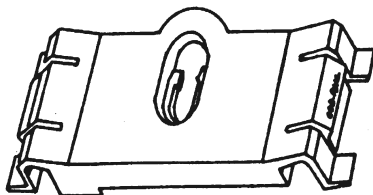
**87-6287**

Replaces: 20218853
CLIP-ROOF SIDE
 Moulding, VINYL ROOF
 Plastic
 Buick Regal '82 - '87
UNIT PACKAGE 25

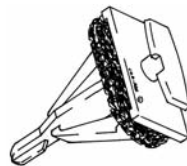
**99-8749**

Replaces: 10383817, 11610522
RETAINER-SIDE WINDOW
 REVEAL Moulding (REAR)
 Plastic w/Seal
 Hole: M8, Upper Hd.: 6x11MM,
 O/L: 25MM, P.R.: 2MM, Trim Thk.: 2MM
 Buick Lucerne 2006/
UNIT PACKAGE 10

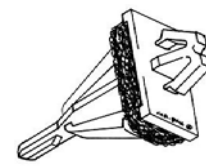
**99-8750**

Replaces: 11569697
RETAINER-SIDE WINDOW
 REVEAL Moulding (REAR)
 Plastic w/Seal
 Hole: M8, O/L: 29MM, P.R.: 2MM,
 Trim Thk.: 2MM
 Buick Lucerne 2006/
UNIT PACKAGE 5

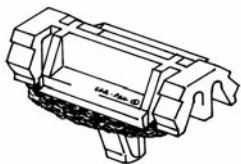

99-8751

Replaces: 11570512
**RETAINER-SIDE WINDOW
 REVEAL MOULDING**
 Plastic w/Seal
 Hole: M6, O/L: 13MM, P.R.: 1.5MM
 Buick Lucerne 2006/
UNIT PACKAGE 10

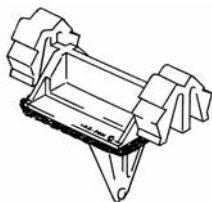

99-8737

Replaces: 11569918
RETAINER-ROOF RAIL MOULDING
 Plastic w/Seal
 Hole: M7
 Buick Terraza & GMC Acadia 2007/
UNIT PACKAGE 15



FENDER & WHEEL OPENINGS

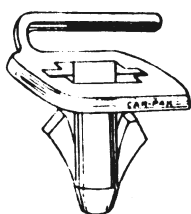

78-4954

Replaces: 10001671
RETAINER-FRONT FENDER MOULDING
 Pontiac '78/, Grand LeMans
 (4-Door) & Station Wagon
UNIT PACKAGE 50



77-4624

Replaces: 10001670
**RETAINER-FRONT FENDER
 SIDE MOULDING**
 Pontiac '78/
UNIT PACKAGE 50

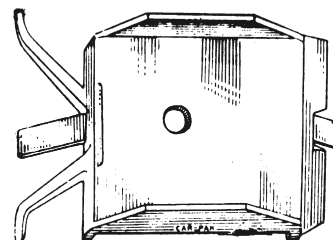

78-4743

Replaces: 10003647
**CLIP-FRONT FENDER SIDE
 MOULDING, LOWER REAR**
 G.M. Cars '78/
UNIT PACKAGE 50

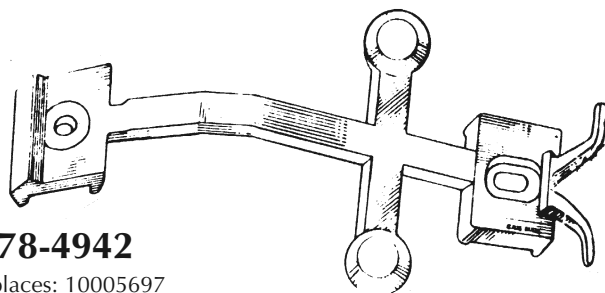

78-4942

Replaces: 10005697
CLIP-FRONT FENDER
 G.M. '79/
UNIT PACKAGE 10

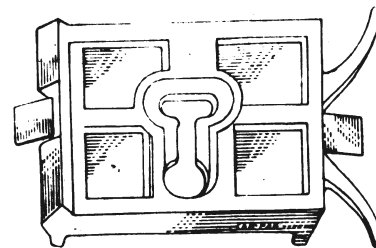

79-5061

Replaces: 1262137
**CLIP-FRONT FENDER
 MOULDING, LOWER**
 Buick '80/
UNIT PACKAGE 10

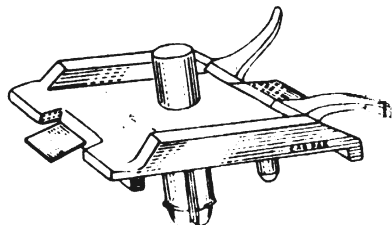

79-5106

Replaces: 10009485
**RETAINER-FRONT FENDER
 MOULDING, LOWER**
 Buick '80/
UNIT PACKAGE 50

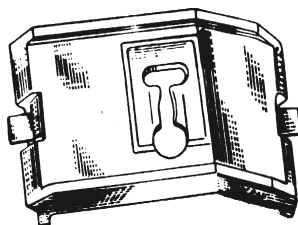

77-4584

Replaces: 3085245
**CLIP-OUTER PANEL MOULDING
 REAR OF WHEEL OPENING**
 G.M. '78/
UNIT PACKAGE 50



74-3948

Replaces: 9842872
**CLIP-FRONT OF WHEEL
 OPENING MOULDING**
 Olds '71 - '72
UNIT PACKAGE 100

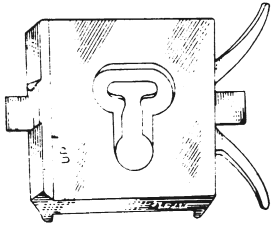

79-5062

Replaces: 1262138
**CLIP-FRONT FENDER
 MOULDING, LOWER**
 Buick '80/
UNIT PACKAGE 10

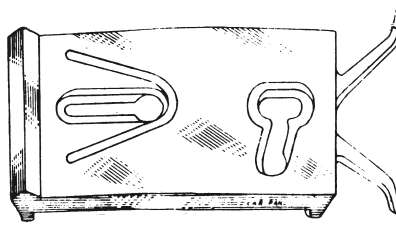

79-5063

Replaces: 1262139
**CLIP-FRONT FENDER
 MOULDING, LOWER**
 Buick '80/
UNIT PACKAGE 10

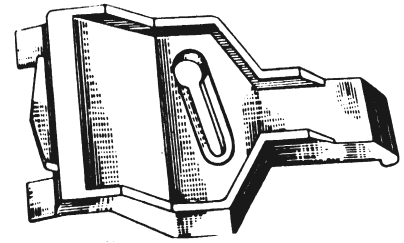

79-5103

Replaces: 20199336
**CLIP-MOULDING, FRONT OF
 REAR OPENING**
 G.M. '80/
UNIT PACKAGE 25

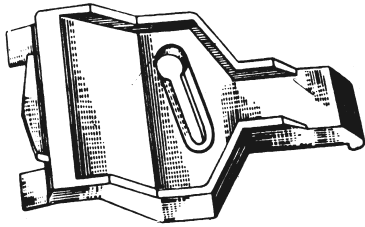

76-4366

Replaces: 20036941
**CLIP-OUTSIDE PANEL MOULDING
 FRONT & REAR OPENING**
 G.M. '77/
UNIT PACKAGE 50

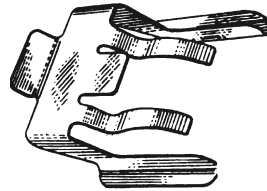

79-5117

Replaces: 1261382
CLIP-FRONT FENDER MARKING LIGHT
 Buick Skylark '80/
UNIT PACKAGE 25

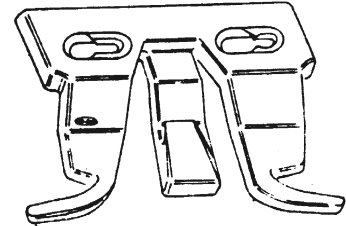

84-5866

Replaces: 20460084
**CLIP-COWL VENT
 PANEL TO FENDER**
 (Right), Plastic
 G.M. "A" Bodies '83/
UNIT PACKAGE 25

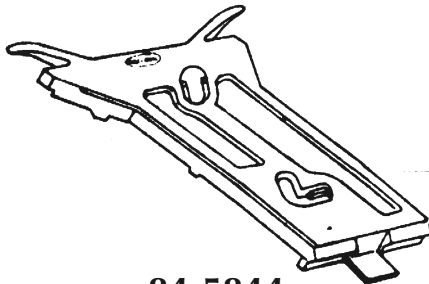

84-5844

Replaces: 20518973
CLIP-FENDER MOULDING
 Plastic
 G.M. "C" Body, Olds 98 '85/
UNIT PACKAGE 10

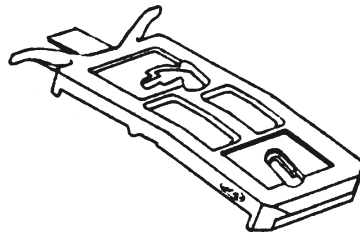

84-5864

Replaces: 20516001
CLIP-BODY SIDE MOULDING
 G.M. "J", "B" '84/
UNIT PACKAGE 25

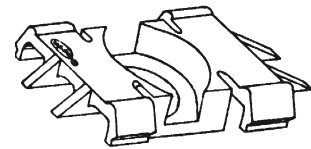

84-5873

Replaces: 20356051
CLIP-FENDER & QUARTER MOULDINGS
 Plastic
 G.M. Fiero "P" Body '84/
UNIT PACKAGE 25

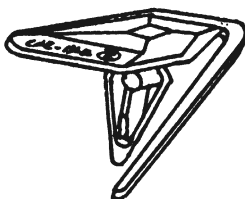

86-6151

Replaces: 25506153
CLIP-FENDER MOULDING
 Buick "B", "C", & "D"
 Models '82 - '84
UNIT PACKAGE 50

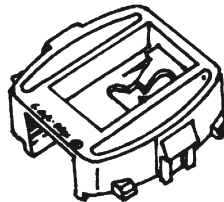

89-6589

Replaces: 20730526
CLIP-FENDER MOULDING
 Plastic
 Pontiac Bonneville '87/
UNIT PACKAGE 25

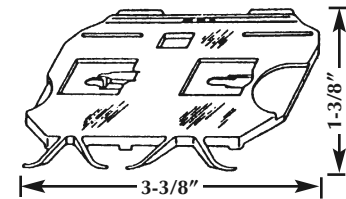

88-6476

Replaces: 20675100
CLIP-FENDER & DOOR MOULDING
 Plastic
 G.M., Buick "C" & "H" Body '85/
UNIT PACKAGE 10

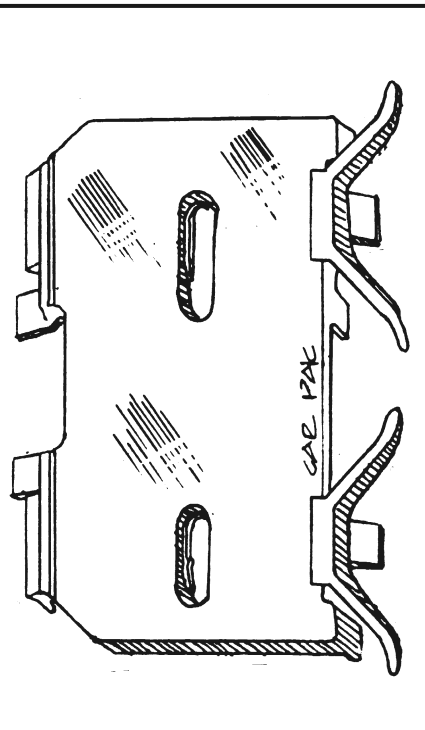

81-5401

Replaces: 22513784
**CLIP-FENDER EXTENSION
 MOULDING, LOWER**
 G.M. '82/
UNIT PACKAGE 10

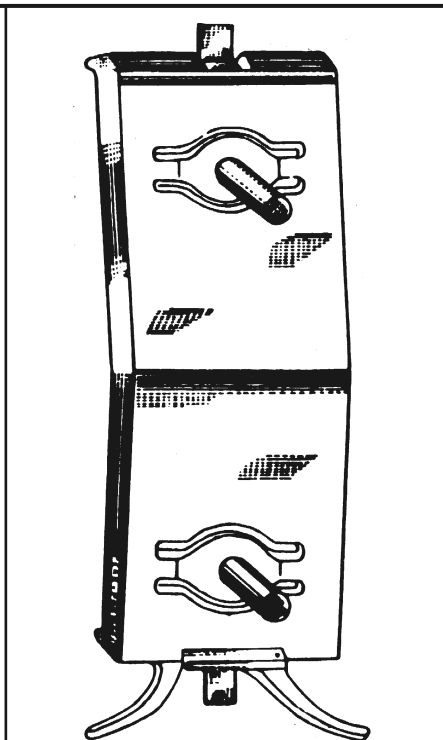

77-4598

Replaces: 560396
**RETAINER-FENDER LOWER
 MOULDING, REAR**
 Olds '78/
UNIT PACKAGE 25

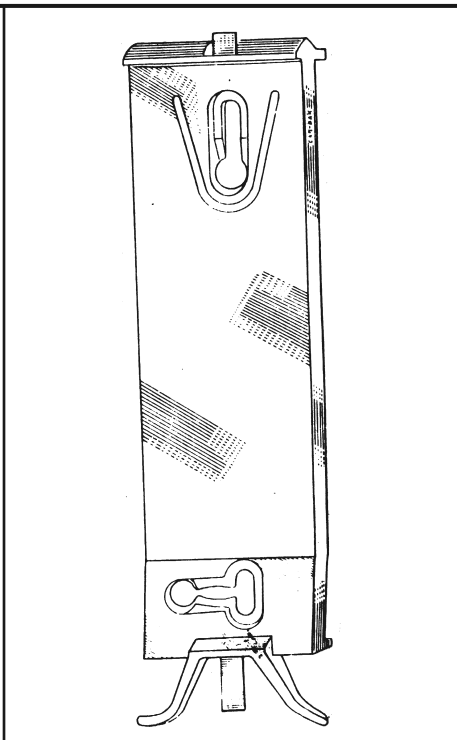

78-4882

Replaces: 14005390
**CLIP-FRONT WHEEL OPENING
 MOULDING**
 G.M. '79/
UNIT PACKAGE 25

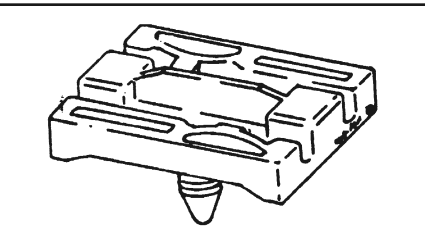

91-6883

Replaces: 20730532
**RETAINER-FRONT FENDER
 MOULDING, LOWER**
 Plastic
 G.M., Pontiac Bonneville '87/
UNIT PACKAGE 25

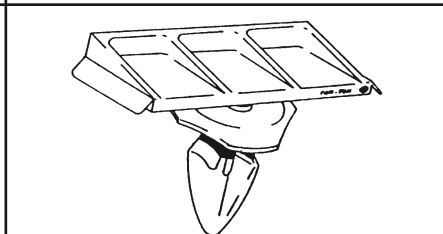

91-6982

Replaces: 16614134
RETAINER-FRONT FENDER MOULDING
 Plastic
 Olds Cutlass Supreme '92/
 Pontiac Grand Prix '91/
UNIT PACKAGE 10

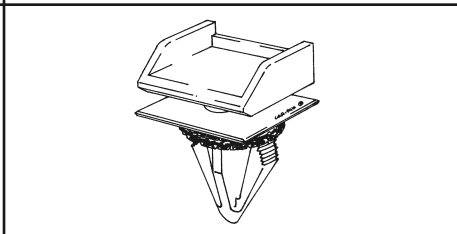

99-8230

Replaces: 10297371
RETAINER - REAR WHEEL OPENING FLARE
 Plastic-Yellow
 Hole: M12
 G.M. 'U' Body Vans 120" W. B. '97/
UNIT PACKAGE 15

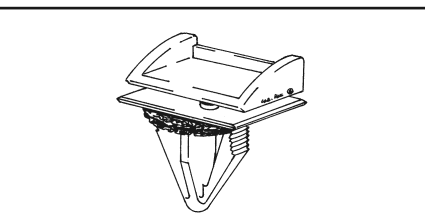

99-8231

Replaces: 10297368
**RETAINER - REAR WHEEL OPENING
 FLARE**
 Plastic-White
 Hole: M12
 G.M. 'U' Body Vans 112" W. B. '97/
UNIT PACKAGE 10

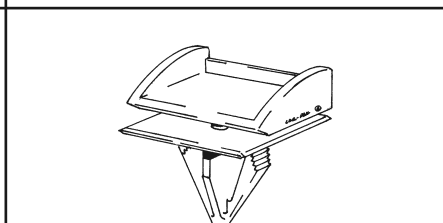

99-8232

Replaces: 10242298
RETAINER - FRONT FENDER FLARE
 Plastic-Black
 Hole: M10
 G.M. 'U' Body Vans '97/
UNIT PACKAGE 15

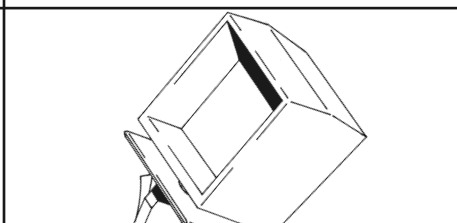

99-8234

Replaces: 10270517
RETAINER - FRONT FENDER FLARE
 Plastic
 Hole: M12
 G.M. 'U' Body Vans '97/
UNIT PACKAGE 5

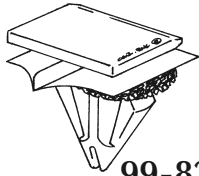
**99-8244**

Replaces: 11518357, 10443956
RETAINER - FENDER, SIDE & RKR
 MOULDING, FRONT BUMPER,
 CARGO BOX
 Plastic w/seal
 Hole: M10
 Cadillac Escalade, G.M. C/K Trucks &
 'W' Bodies 2000/ & Ford Edge/MKX 2007/
UNIT PACKAGE 25

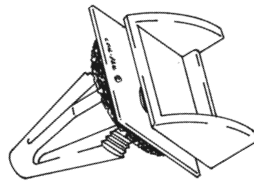
**99-8544**

Replaces: 10297370
RETAINER-BODY & FENDER
 MOULDINGS
 Plastic w/Seal
 Hole: M11
 G.M. 'U' Vans & Hummer '97/
UNIT PACKAGE 10

**95-7376**

Replaces: W701054-S300
RIVET-DRIVE TYPE, FRONT BUMPER,
 FENDER APRON
 Hole: M8, Head: 25MM
 P.R.: 5.8 - 8.7MM
 Black Plastic
 Ford Contour & Mercury Mystique '95/
 Cougar '99/, G.M. Colorado/
 Canyon S/T Truck 2004
UNIT PACKAGE 25

**99-8355**

Replaces: 88969790, 75867-21010
RETAINER - FENDER FLARE
 Plastic
 Hole: M8.5, Hd: 10x13MM, O/L: 13.5MM,
 Trim Thk: 2.5MM
 Pontiac Vibe 2003 & Toyota Echo 2002/
UNIT PACKAGE 25

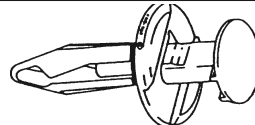
**92-7038**

Replaces: 5485676, 15691478,
 15969147, 21030249, N807389-S,
 W711035-S300, 6503598
RIVET-DRIVE TYPE FENDER APRON,
 BUMPERS & GRILLES
 Hole: M8, Flange: 20MM, P.R. 3-8MM
 Plastic
 G.M. Saturn '91/, G.M. C/K Truck '99/ &
 Hummer, Chrysler '95-2000, Ford 2006/
 Dodge Nitro 2007/ Jeep 2005/
UNIT PACKAGE 50

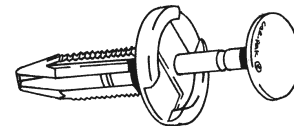
**98-7873**

Replaces: 15149708, W709176-S300
RIVET-DRIVE TYPE, WHEEL SPLASH &
 LOWER RADIATOR SHIELDS
 & SIDE MOULDING
 Plastic
 Hole: M6.3, Flange: 17MM, P.R.: 6MM
 G.M. "C/K" Trucks '99/, S/T Truck 2004/
 For Mustang 2005/
UNIT PACKAGE 25

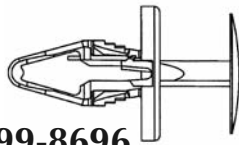
**99-8696**

Replaces: 11589289, W713610-S300,
 6508863AA
RIVET-DRIVE TYPE, Flares, Cowl,
 RKR Moulding., Front Bumper, Plastic
 Hole: M6.25-6.53, Flange: 18MM,
 Stem Lgth: 17.5MM, P.R.: 2-4MM
 G.M. Equinox & Torrent 2007,
 Buick Enclave, Saturn '91/
 Ford Focus 2008/ & Dodge PU 2009/
UNIT PACKAGE 25

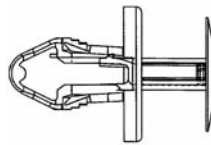
**99-8697**

Replaces: 15296830, 5116530AA
RIVET-DRIVE TYPE,
 FLARES & PANELS
 Plastic
 Hole: M7.75-8.25, Flange: 19MM,
 Stem Lgth: 16MM, P.R.: 5-7MM
 G.M. & Dodge Caliber & Charger, Jeep
 Patriot 2006/
UNIT PACKAGE 25

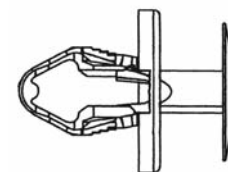
**99-8552**

Replaces: 11609417
RIVET-DRIVE TYPE, FENDER APRON
 Plastic
 Hole: M8.25-8.53, Flange: 19MM,
 Stem Lgth: 14MM, P.R.: 2.7-5.3MM
 G.M. Cobalt, G5 2005
 Avalanche, Escalade & Acadia 2007/
UNIT PACKAGE 50

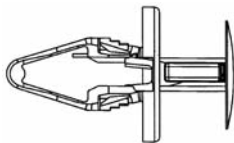
**99-8698**

Replaces: 11589292
RIVET-DRIVE TYPE,
 AIR DAM, FENDER FLARES/APRON
 Plastic
 Hole: M8.25-8.53, Flange: 20MM,
 Stem Lgth: 20MM, P.R.: 2-4.5MM
 G.M. Full Size Pick Up & SUV 2006/
 Cadillac Escalade 2007/
UNIT PACKAGE 25

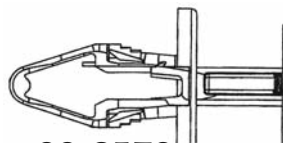
**99-8579**

Replaces: 11589293, W712196-S300
RIVET-DRIVE TYPE,
 COWL VENT, FENDER & BUMPER Plastic
 Hole: M8.25-8.53, Flange: 20MM,
 Stem Lgth: 21.5MM, P.R.: 4.5-7.0
 G.M. 'W', 'N' Body & Hummer 2005/
 Full Size SUV & Suburban 2007/
 Ford Edge/MKX 2007/, Flex 2009
 Fusion/MKZ/Zephyr/Milan2006/
UNIT PACKAGE 25

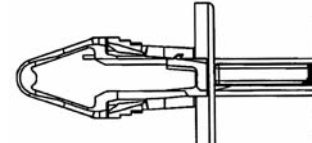
**99-8699**

Replaces: 11589294
RIVET-DRIVE TYPE,
 FENDERS & BUMPERS, Plastic
 Hole: M8.25-8.53, Flange: 20MM,
 Stem Lgth: 24MM, P.R.: 7.0-10MM
 Buick LaCrosse/Allure 2005/, Chevrolet
 Traverse 2009
 G.M. C/K Trucks, SUV's Hummer 2007/
UNIT PACKAGE 25

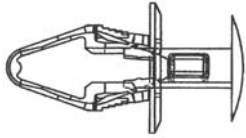
**99-8580**

Replaces: 11561368, 6508712AA

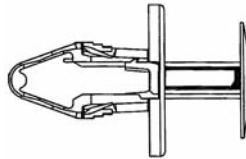
**RIVET-DRIVE TYPE, FENDER,
WHEEL & BUMPER**
PlasticHole: M9.25-9.53, Flange: 18MM,
Stem Lgth: 20MM, P.R.: 3.0-5.7MM
G.M. 'W' & 'M' Body 2006,
Jeep Wrangler 2006/
UNIT PACKAGE 25**99-8701**

Replaces: 11589296

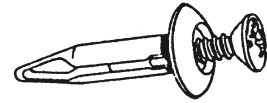
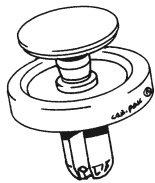
**RIVET-DRIVE TYPE,
FENDER APRON**
PlasticHole: M10.25-10.53, Flange: 25MM,
Stem Lgth: 23MM, P.R.: 6.0-9MM
G.M. 2007/
UNIT PACKAGE 25**86-6096**Replaces: N-804570-S,
20664092 & 6502790**RIVET-COWL, INT. TRIM, GRILLE,
ROCKER PNL., WHEEL LIP MOULDING**
Black Plastic, Hole: M6.3
P.R.: 2.5MM - 8.0MM
Washer Face Dia.: 18.0MM
Ford, G.M., Chrysler Products
& Cadillac '98/
UNIT PACKAGE 25**99-8373**

Replaces: 88970767, 90467-10183

RIVET-DRIVE TYPE, FRONT FENDER LINER
Hole: M7, Flange: 18MM,
Stem Lgth: 7.5MM, P.R. 3MM
Pontiac Vibe 2003,
Toyota Celica, Corolla, Solara & Matrix '99/
UNIT PACKAGE 10**99-8223**

Not Supplied by O.E.

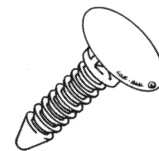
**GROMMET - REAR WHEEL OPENING
FLARE**Plastic - use w/ 99-8222
Hole: M8, Flange: 16MM, O/L: 16MM,
P.R.: 1 MM
Pontiac Aztek 2001
UNIT PACKAGE 15**99-8222**

Replaces: 10436656

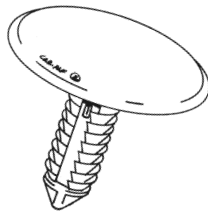
**RETAINER - REAR WHEEL
OPENING FLARE**Plastic - use w/ 99-8223
Hole: M5, Head: 16MM, O/L: 18.8MM,
Shoulder: 3x7.5MM
Pontiac Aztek 2001
UNIT PACKAGE 15**99-8401**

Replaces: 11517992

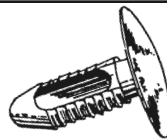
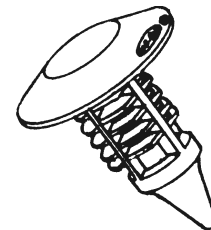
RETAINER-FENDER LINERPlastic, Textured
Hole Dia.: M7, Head: 35MM,
P.R.: 2-14MM
Pontiac Bonneville 2000/
UNIT PACKAGE 25**85-5947**Replaces: 22718305,
N802734-S, N808679-S**RETAINER-FENDER APRON,
FR. BUMPER, HOOD INS.**Plastic: Textured
Hole: M7, Head: 25.4MM,
Stem Lgth.: 20MM, P.R.: 2-10MM
G.M. Cars & Lt. Duty Truck 2004/
Ford Mustang 2001/
UNIT PACKAGE 50**85-5952**

Replaces: N90282401, 3096724

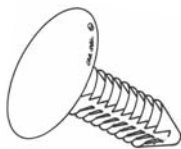
CLIP-DOOR TRIM PANELS FENDERS
M8 HoleVolkswagen Rabbit, G.M. S10 2004/
UNIT PACKAGE 50**99-8683**

Replaces: 24501057

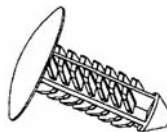
**RETAINER-FENDER APRON
& RADIATOR BAFFLE**Plastic
Hole: M8, Head: 25.4MM,
Stem Lgth: 18.7MM, P.R.: 2.8-13MM
GM Denali, Escalade, Tahoe &
Yukon 2003/, Hummer H3 2006/
UNIT PACKAGE 25**99-8775**

Replaces: 11589181, W711687-S300

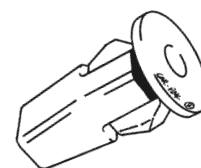
**RETAINER-BUMPER END CAP
& FENDER APRON**Plastic
Hole: M6.3, Head: 18MM,
Stem Lgth: 20MM, P.R.: 14MM Max
G.M. Full Size Pick Ups 2007/
Ford Focus
UNIT PACKAGE 25**98-7840**

Replaces: 90189-06028, 94854203

RETAINER- WHEEL APRONPlastic
Hole: M9 sq., Flange: 16MM, O/L: 20MM
P.R.: 2-3MM
Toyota Tacoma, T100 & 4Runner '95/
& Pontiac Vibe 2003/
UNIT PACKAGE 15

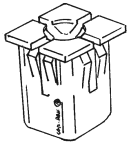

99-8345

Replaces: 3547221
GROMMET - INTERIOR DOOR TRIM & FENDER LINER
 Plastic
 Hole: M7 sq., Flange: 9.5MM, O/L: 9.9MM,
 PR: 1.5MM, Screw: M4.2 (#8)
 G.M. '94/
 UNIT PACKAGE 50

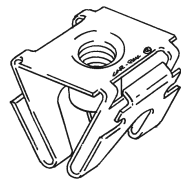

98-7800

Replaces: 15707256
NUT-EXTRUDED, SNAP IN TYPE
 License Plate, Fender, Sunroof
 M6-1.0 Fits 13 X 20MM Hole
 Organic Zinc Finish
 G.M. "G", "S" & "T" Trucks '96/
 UNIT PACKAGE 10

**"MUST HAVE"
 BODY SHOP
 STARTER
 ASSORTMENTS
 ON PAGES
 578 & 549**

DOOR, QUARTER, ROCKER & DECK MOULDINGS



71-3516

Replaces: 9828420
CLIP-MOULDING
 Plastic
 G.M. Cars '71 - '75
 UNIT PACKAGE 100



77-4719

Replaces: 9828421
CLIP-SIDE MOULDING
 G.M. '69/, Cadillac '76 - '77
 UNIT PACKAGE 50

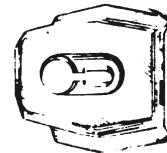

68-3216

Replaces: 4557495
CLIP-DOOR & QUARTER MOULDING
 Nylon
 Chevrolet Biscayne '67 - '75
 Impala '68-'75, Olds 88 '68-'75
 Buick Skylark '68 - '75
 General Usage on G.M.
 Cars '67 - '75
 UNIT PACKAGE 100

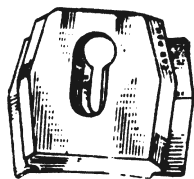

73-3815

Replaces: 7656277
CLIP-SIDE MOULDING
 G.M. '69-'85
 UNIT PACKAGE 100

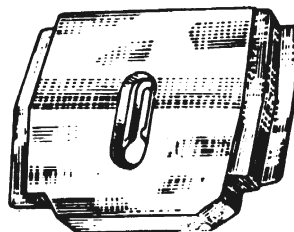

74-3967

Replaces: 7737942
CLIP-LOWER MOULDING
 FRONT & REAR DOOR
 Chevrolet, Buick, Pontiac '72 - '74
 UNIT PACKAGE 100

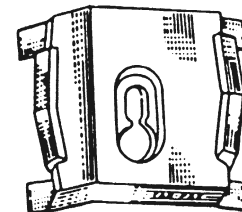

77-4602

Replaces: 472181
CLIP-MOULDING
 Chevrolet '78/
 UNIT PACKAGE 100

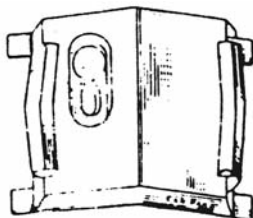

77-4591

Replaces: 20065255
CLIP-MOULDING
 OUTER PANEL, LOWER
 G.M. '78/
 UNIT PACKAGE 50

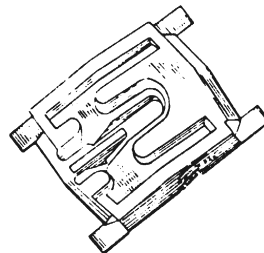

78-4757

Replaces: 20065264
CLIP-REAR QUARTER MOULDING
 FRONT OF WHEEL OPENING
 Chevrolet Monte Carlo '78/
 UNIT PACKAGE 50

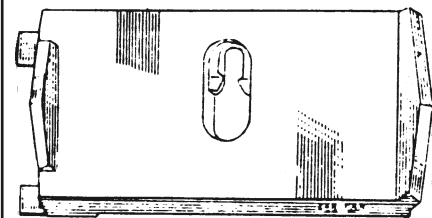

78-4886

Replaces: 20131182
CLIP-ROOF PANEL COVER
 MOULDING
 G.M. '79/
 UNIT PACKAGE 25

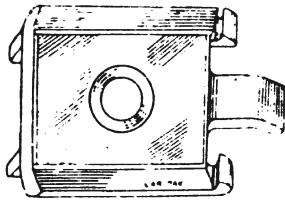

79-5072
 Replaces: 20158277
CLIP-LOCATING QUARTER PANEL MOULDING
 G.M. '80/
UNIT PACKAGE 50

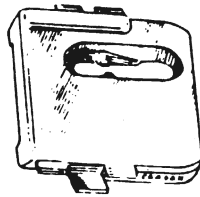

74-3956
 Replaces: 1236415
CLIP-FOR 1-1/4" ROCKER PANEL MOULDING
UNIT PACKAGE 100

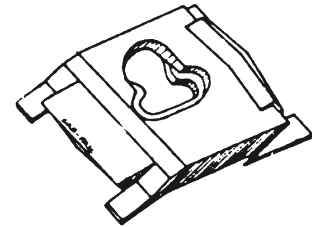

82-5502
 Replaces: 20184550
CLIP-QUARTER PANEL MOULDING
 Chevrolet Caprice, Chevrolet and Buick '81/
UNIT PACKAGE 50

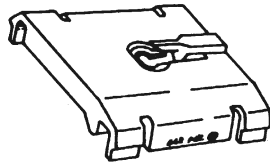

89-6674
 Replaces: 20474691
CLIP-BODY SIDE MOULDING DOOR QUARTER PANEL
 Plastic
 G.M. "W" Body '88/
UNIT PACKAGE 25

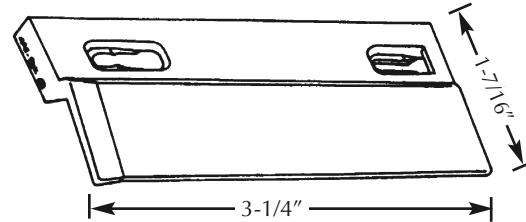

87-6363
 Replaces: 20641049 & 10091281
CLIP-ROCKER PANEL MOULDING
 L.H. Plastic
 Accent Moulding
 Pontiac Grand Prix '88/
UNIT PACKAGE 15

87-6362
 Replaces: 20641048 & 10091280
CLIP-ROCKER PANEL MOULDING
 R.H. Plastic
 Accent Moulding
 Pontiac Grand Prix '88/
UNIT PACKAGE 15

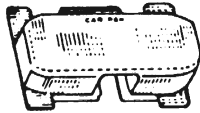

76-4386
 Replaces: 20046150
CLIP-MOULDING
 G.M. '77
UNIT PACKAGE 100

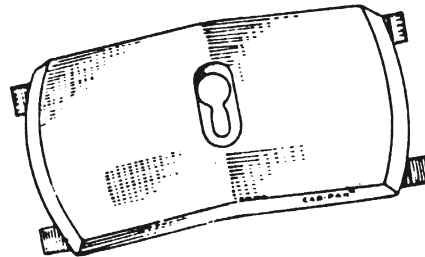

76-4365
 Replaces: 20037240
CLIP-QUARTER PANEL MOULDING & REAR OF REAR WHEEL OPENING
 G.M. '77/
UNIT PACKAGE 50

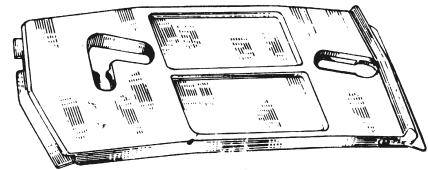

74-3966
 Replaces: 9829248
CLIP-ROCKER PANEL MOULDING (Wide)
 Buick, Electra, Riviera, La Sabre '72
 Pontiac & Buick "A" Bodies '73 - '74
UNIT PACKAGE 50

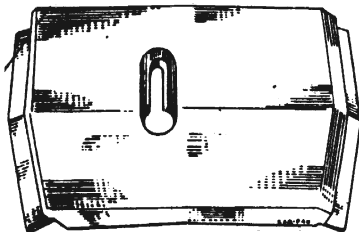

73-3816
 Replaces: 9827269
CLIP-LOWER CENTER MOULDING
 Olds '71
UNIT PACKAGE 50

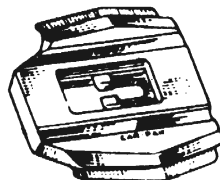

76-4306
 Replaces: 4551193
CLIP-EXTERIOR MOULDING
 Buick, Olds, Pontiac Various
 Moulding '65/
UNIT PACKAGE 100



74-3964
 Replaces: 96447459
CLIP-MOULDING
 FRONT DOOR (LOW CENTER)
 REAR DOOR (LOWER FRONT)
 Chevrolet, Olds, Pontiac '73
UNIT PACKAGE 50

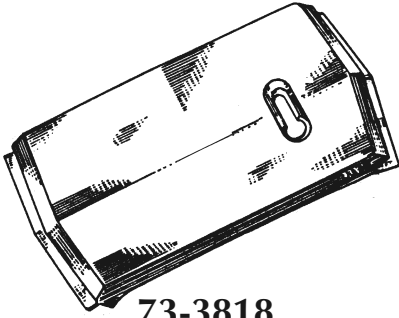

73-3818

Replaces: 9831540
CLIP-MOULDING
 G.M. Cars '73
UNIT PACKAGE 50

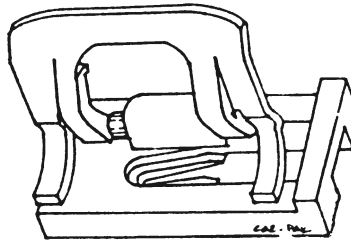

82-5522

Replaces: 20178573
CLIP-PANEL APPLIQUE, REAR
COMPARTMENT, FRONT
 Chevrolet, Olds, Pontiac, Buick '80/
 "A" Cars
UNIT PACKAGE 25

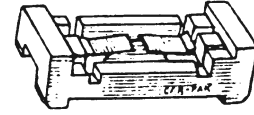

80-5232

Replaces: 14022878
CLIP-MOULDING
 G.M. '81/
UNIT PACKAGE 50



85-5928

Replaces: 20444101
CLIP-DOOR MOULDING
 Plastic
 G.M. "C" Bodies '85/
UNIT PACKAGE 50



87-6212

Replaces: 20481545
CLIP-BODY SIDE MOULDING
 Plastic
 Olds "C" Body (FWD) '85/
UNIT PACKAGE 50

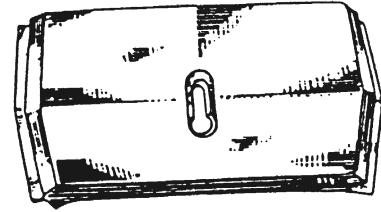

87-6330

Replaces: 8798548
CLIP-BODY SIDE MOULDING
 Plastic
 Cadillac Fleetwood (RWD) '85/
UNIT PACKAGE 25

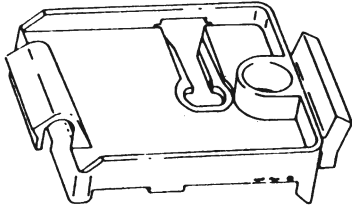

91-6908

Replaces: 25601097
CLIP-BODY SIDE MOULDING
LOWER FINISH PANEL
 Plastic
 G.M. Buick Park Avenue Ultra '91/
UNIT PACKAGE 15

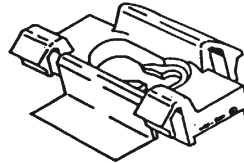

92-7050

Replaces: 25601236
CLIP-BODY SIDE MOULDING
FRONT & REAR DOORS
 Plastic
 Olds 98 '91/
UNIT PACKAGE 25

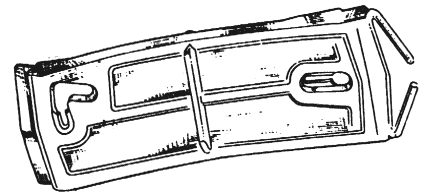

73-3817

Replaces: 9613286
CLIP-BELT MOULDING
FRONT & REAR DOOR CENTER
MOULDING
 Chevrolet, Malibu, El Camino
 Laguna '73/
UNIT PACKAGE 50

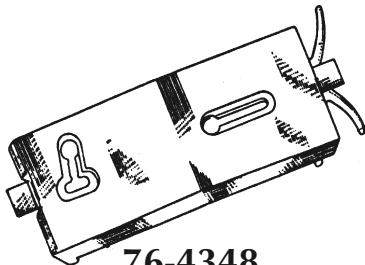

76-4348

Replaces: 343000
CLIP-BODY SIDE MOULDING
 Pick Ups, Blazers
 Trucks w/ Wide Mouldings on Tailgate
 G.M. '73/
UNIT PACKAGE 50

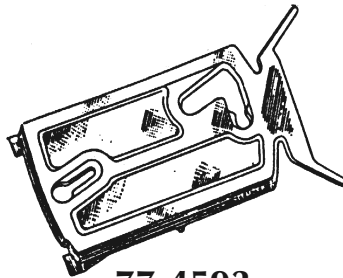

77-4593

Replaces: 20071325
CLIP-COMPARTMENT, LID OPENING
FRONT
 G.M. Cars '78/
UNIT PACKAGE 50

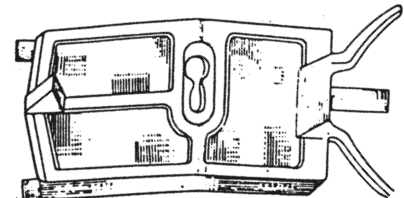

77-4574

Replaces: 20061151
CLIP-OUTER PANEL
LOWER MOULDING
 G.M. '78/
UNIT PACKAGE 25

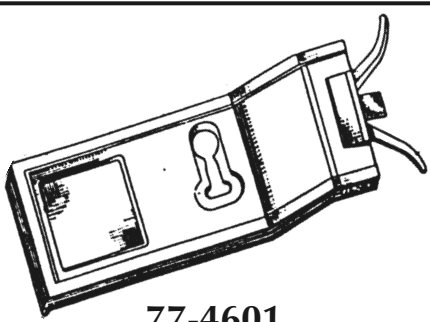

77-4601
 Replaces: 20084950
CLIP-MOULDING
 G.M. '78/
 UNIT PACKAGE 25

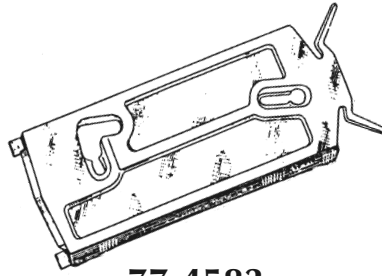

77-4583
 Replaces: 3074701
CLIP-OUTER PANEL MOULDING
 FRONT OF REAR
 G.M. '78/
 UNIT PACKAGE 50

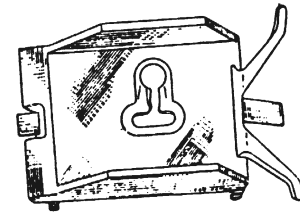

78-4876
 Replaces: 20112763
RETAINER-BODY SIDE MOULDING
 G.M. '79/
 UNIT PACKAGE 50

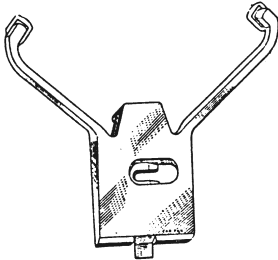

78-4870
 Replaces: 20103175
CLIP-REAR OF WHEEL OPENING
 MOULDING
 G.M. '79-1/2/
 UNIT PACKAGE 50

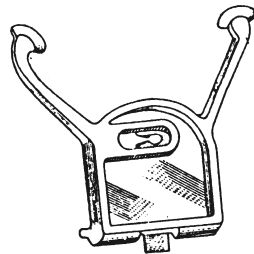

78-4881
 Replaces: 20120049
CLIP-OUTER PANEL FRONT DOOR
 MOULDING, LOWER
 G.M. '79/
 UNIT PACKAGE 25

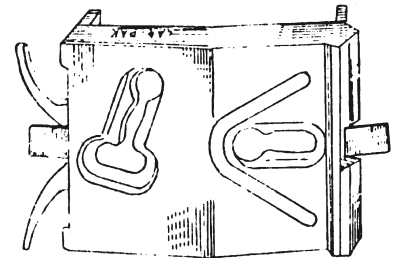

80-5263
 Replaces: 10013154
CLIP-ROCKER PANEL MOULDING
 G.M. '81/
 UNIT PACKAGE 25

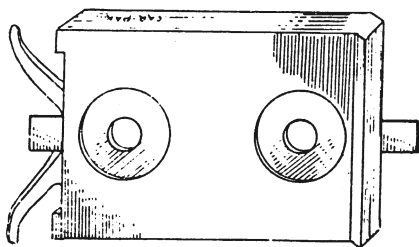

80-5262
 Replaces: 10013153
CLIP-ROCKER PANEL MOULDING
 TO FENDER
 G.M. '81/
 UNIT PACKAGE 25

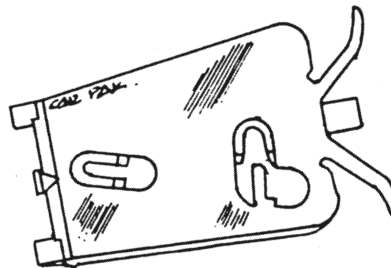

81-5450
 Replaces: 20338568
CLIP-OUTER PANEL FRONT OF
 REAR WHEEL OPENING MOULDING
 G.M. '82/
 UNIT PACKAGE 25

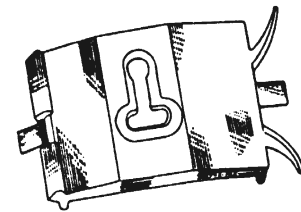

83-5722
 Replaces: 14070531
CLIP-PICK UP BOX SIDE MOULDING
 Chevrolet Pick Up Truck '84/
 UNIT PACKAGE 25

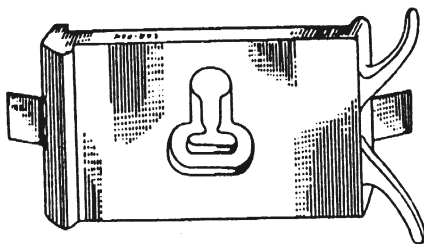

79-5086
 Replaces: 14008539
CLIP-ROCKER PANEL MOULDING
 G.M. '80/
 UNIT PACKAGE 25

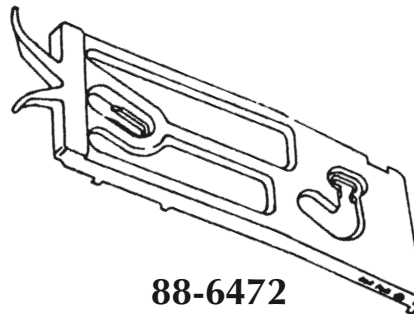

88-6472
 Replaces: 20534970 & 20615572
CLIP-QUARTER PANEL MOULDING
 Plastic, Right Side
 G.M. Olds "C" Body '85/
 UNIT PACKAGE 15

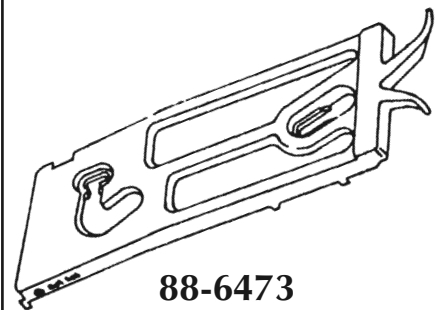

88-6473
 Replaces: 20534971 & 20615573
CLIP-QUARTER PANEL MOULDING
 Plastic, Left Side
 G.M. Olds "C" Body '85/
 UNIT PACKAGE 15

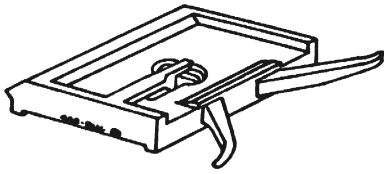

87-6214

Replaces: 20557574
CLIP-BODY SIDE MOULDING
 Plastic
 Pontiac "H" Body '87/
 UNIT PACKAGE 25

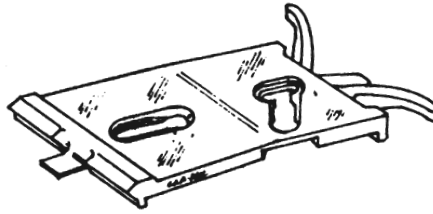

89-6600

Replaces: 20511590
CLIP-ROCKER PANEL MOULDING
 Plastic
 Oldsmobile "H" Body '88 - '89
 UNIT PACKAGE 25

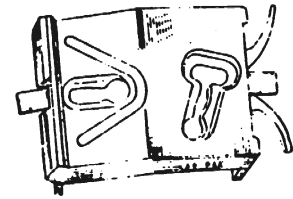

88-6391

Replaces: 22518828
CLIP-ROCKER PANEL MOULDING
 Plastic
 G.M. "N" Bodies '85/
 UNIT PACKAGE 15

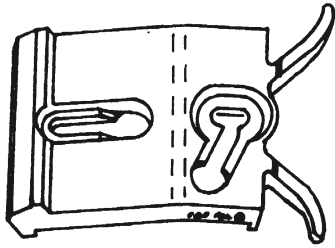

87-6331

Replaces: 20565201
CLIP-ROCKER PANEL MOULDING
 Plastic
 G.M. Buick "W" Regal '88/
 UNIT PACKAGE 25

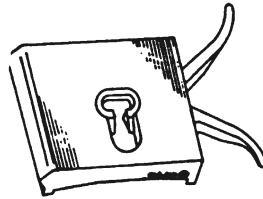

87-6360

Replaces: 10091286
CLIP-ROCKER PANEL MOULDING
 Plastic
 Standard Mouldings
 G.M. Pontiac "W" Grand Prix '88/
 UNIT PACKAGE 25

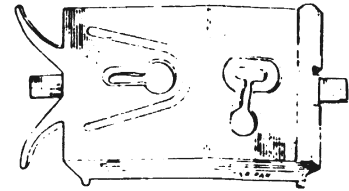

89-6668

Replaces: 14036372
CLIP-ROCKER PANEL MOULDING
 Plastic
 Chevrolet "A" Body '82/
 UNIT PACKAGE 25

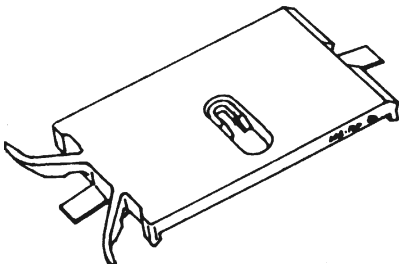

89-6626

Replaces: 20260998
CLIP-ROCKER PANEL MOULDING
 Plastic
 Buick "A" Body '82/
 UNIT PACKAGE 25

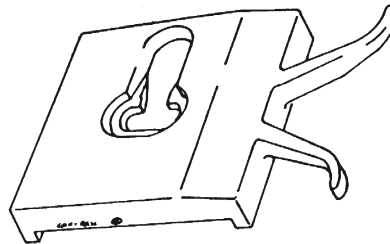

91-6986

Replaces: 25543680
CLIP-BODY SIDE MOULDING
 Plastic
 Lower Moulding Fr. & Rear Door
 Buick Park Avenue '91/
 UNIT PACKAGE 15

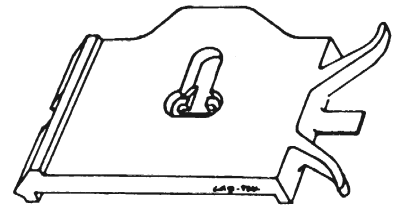

89-6675

Replaces: 20698046
CLIP-BODY SIDE MOULDING
 Plastic
 G.M. Skylark '86/
 UNIT PACKAGE 25

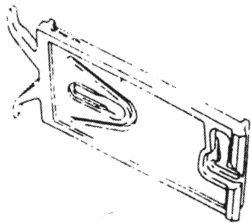

92-7099

Replaces: 15557580
CLIP-LOWER BODY MOULDING
 Plastic
 G.M. Mini Vans '90/
 UNIT PACKAGE 25

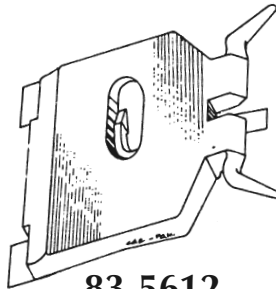

83-5612

Replaces: 20117500
**RETAINER-BODY SIDE CHROME FRONT
 & REAR DOOR MOULDING, LOWER**
 "X" Body Olds '80/
 UNIT PACKAGE 25

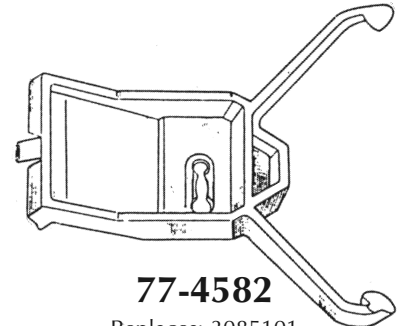

77-4582

Replaces: 3085101
**CLIP-OUTER PANEL DOOR MOULDING,
 LOWER**
 G.M. '78/
 UNIT PACKAGE 50

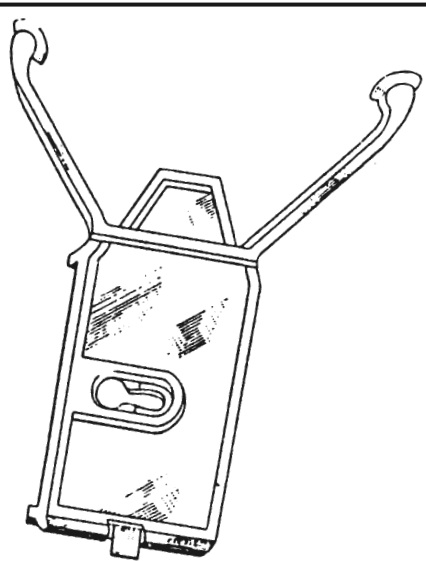

78-4875

Replaces: 20105895
CLIP-OUTER PANEL FRONT DOOR
 MOULDING, LOWER
 G.M. '79/
 UNIT PACKAGE 50

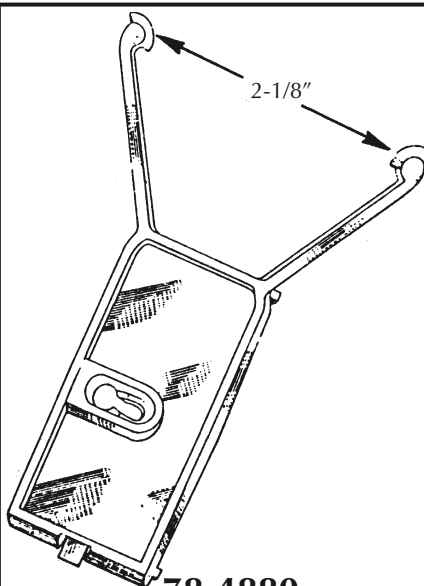

78-4880

Replaces: 20113567
CLIP-OUTER PANEL REAR OF WHEEL
 OPENING MOULDING
 G.M. '79/
 UNIT PACKAGE 25

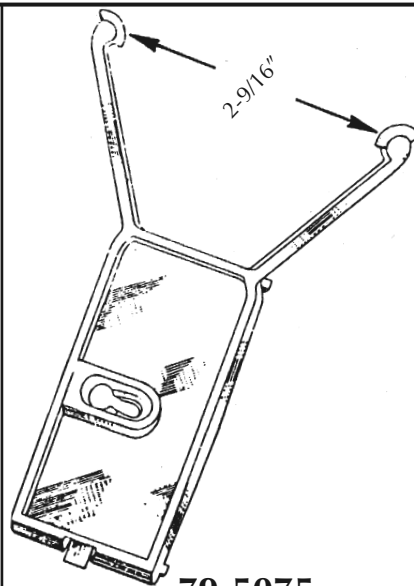

79-5075

Replaces: 20167362
CLIP-OUTER PANEL DOOR
 MOULDING, LOWER
 G.M. '80/
 UNIT PACKAGE 25

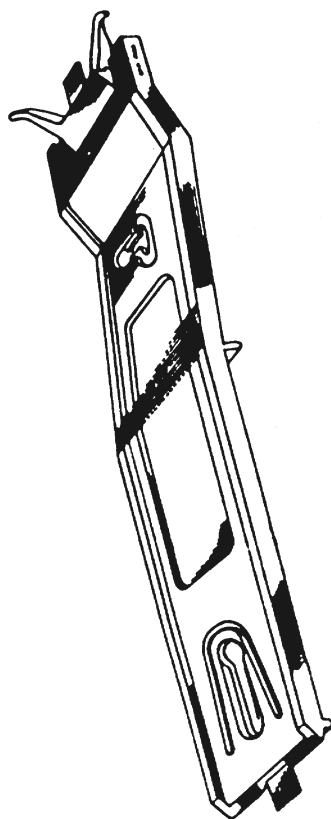

76-4359

Replaces: 20025649
CLIP-FRONT & REAR DOOR
 CENTER MOULDING
 G.M. '77/
 UNIT PACKAGE 50

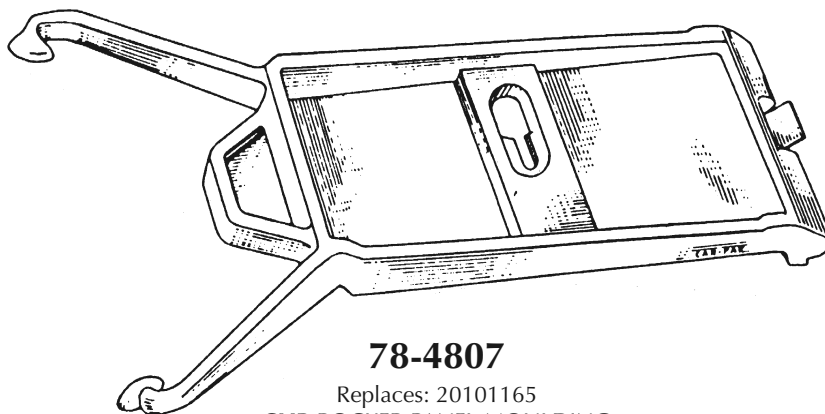

78-4807

Replaces: 20101165
CLIP-ROCKER PANEL MOULDING
 G.M. '79/
 UNIT PACKAGE 25

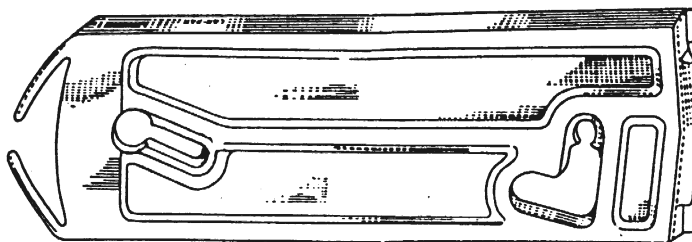

76-4357

Replaces: 20020346
CLIP-OUTER PANEL MOULDING,
 LOWER
 G.M. '77/
 UNIT PACKAGE 50

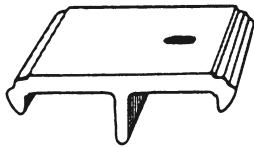
**J04547**

Replaces: 6263345
CLIP-BODY SIDE MOULDING
 Nylon
 Chevy & GMC Trucks
UNIT PACKAGE 25

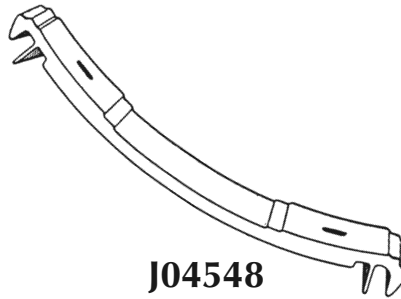
**J04548**

Replaces: 6263346
CLIP-BODY SIDE MOULDING
 Plastic
 Chevy & GMC Trucks
UNIT PACKAGE 10

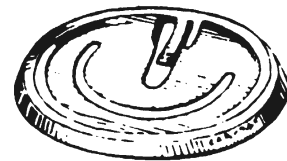
**94-7234**

Replaces: 22506785
CLIP-ROCKER PANEL MOULDING
 Plastic
 G.M. '76 - '89
UNIT PACKAGE 15

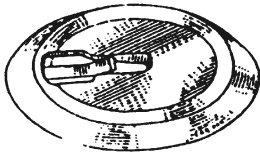
**92-7051**

Replaces: 25606388
CLIP-FRONT DOOR MOULDING,
 LOWER
 (Use with 92-7052)
 Plastic
 Pontiac Bonneville SSE '92/
UNIT PACKAGE 25

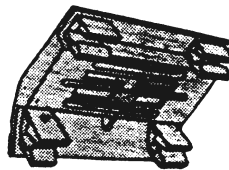
**87-6338**

Replaces: 15597271
CLIP-BODY SIDE MOULDING
 Plastic
 G.M. & G.M.C. "M" Van '85/
UNIT PACKAGE 25

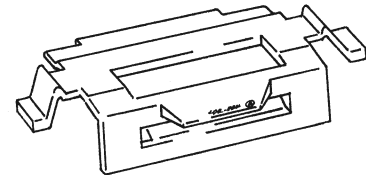
**98-7884**

Replaces: 10287926
CLIP-UPPER DOOR MOULDING
 Plastic
 G.M. "W" Body '97/
UNIT PACKAGE 50

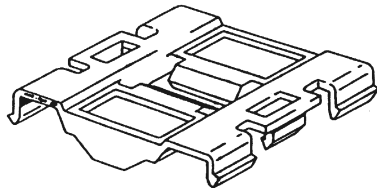
**91-6983**

Replaces: 12508230
CLIP-BODY SIDE UPPER MOULDING
 Plastic
 G.M. Olds '88, '92/
UNIT PACKAGE 10

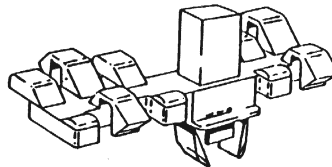
**91-6936**

Not Supplied By O.E.
RETAINER-LOWER BODY SIDE
 MOULDING
 Plastic
 G.M. Olds '98, '91/
UNIT PACKAGE 10

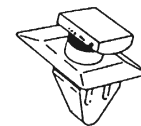
**91-6980**

Replaces: 16611887
RETAINER-BODY SIDE MOULDING
 Plastic
 Pontiac Grand Prix LE/SE '91
UNIT PACKAGE 15

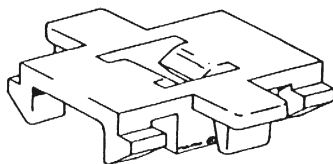
**91-6979**

Replaces: 16611889
CLIP-BODY SIDE MOULDING
 QUARTER PANEL
 Plastic, use w/91-6981
 Pontiac Grand Prix LE/SE '91/
UNIT PACKAGE 10

**91-6981**

Replaces: 16611888
RETAINER-BODY SIDE MOULDING
 Plastic, use w/91-6979
 Pontiac Grand Prix LE/SE '91/
UNIT PACKAGE 15

**99-8210**

Replaces: 10287547
CLIP - DOOR MOULDING
 Plastic
 Hole: M8
 G.M. Regal and Grand Prix '95/
UNIT PACKAGE 25

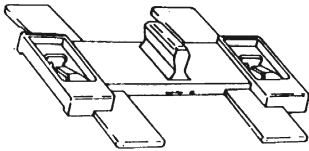

91-6925

Replaces: 20730529
CLIP-LOWER DOOR MOULDING
 Plastic
 Pontiac Bonneville SSE '88/ Olds 98 '91/
UNIT PACKAGE 15

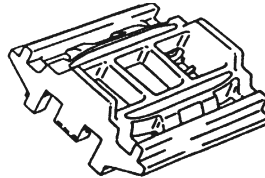

92-7052

Not Supplied By O.E.
CLIP-FRONT DOOR MOULDING, LOWER
 (Use with 92-7051)
 Plastic
 Pontiac Bonneville SSE '92/
UNIT PACKAGE 15

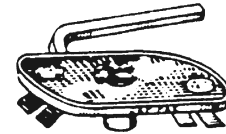

76-4301

Replaces: 7649377
CLIP-MOULDING ENDS
 Chevrolet, Olds, Buick
 General Use
UNIT PACKAGE 50



98-7815

Not Supplied By O.E.
CLIP-T-BOLT TYPE for MOULDINGS
 (Formerly 66-1175)
 Bolt: 10-24 X 3/4" Plate: 5/16 X 3/4"
 G.M. Cars & General Purpose
UNIT PACKAGE 25

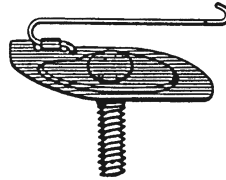

98-7816

Not Supplied By O.E.
CLIP- T-BOLT TYPE for MOULDINGS
 (Formerly 66-3066)
 Bolt: 10-24 X 3/4" Plate: 1/2 X 1-7/16"
 General Purpose
UNIT PACKAGE 25

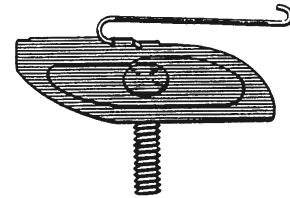

98-7817

Not Supplied By O.E.
CLIP- T-BOLT TYPE for MOULDINGS
 (Formerly 71-3457)
 Bolt: 10-24 X 3/4" Plate: 5/8 X 1-7/8"
 General Purpose
UNIT PACKAGE 25

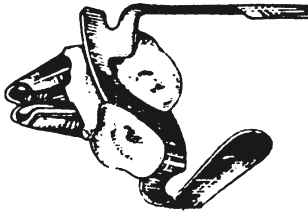

79-4992

RETAINER-w/SEALER
 General Purpose
 G.M. & Other Makes
UNIT PACKAGE 25

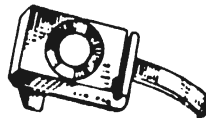

76-4370

Replaces: 20040999
CLIP-LOCATING QUARTER PANEL
MOULDING
 G.M. '77
UNIT PACKAGE 100

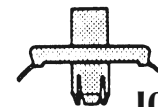
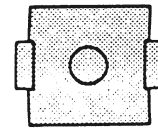

J04301

Replaces: 6001943
CLIP-BODY SIDE MOULDING
 Drive Type
 Plastic
 G.M., Chrysler & General Purpose
UNIT PACKAGE 50

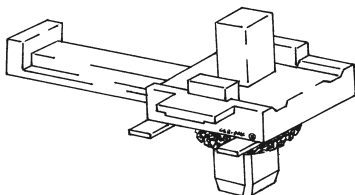

99-8233

Replaces: 10270672
RETAINER - ROCKER MOULDING
 Plastic
 Hole: M6 Sq.
 G.M. 'U' Body Vans '97/
UNIT PACKAGE 10

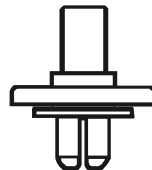

99-8324

Replaces: 10261327
RETAINER - ROCKER MOULDING
 Plastic
 Hole: M8, Slot: 9.5MM, Flange: 21MM sq.
 Buick Rendezvous & Pontiac Aztek 2001/
 & G.M. 'W' Bodies '97/
UNIT PACKAGE 15

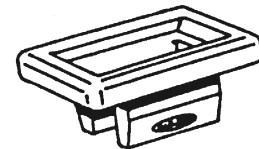

88-6474

Replaces: 20474000
GROMMET-DOOR REMOTE CONTROL
 M7 x 14MM Rectangular Hole
 M4.2 Screw
 Plastic
 G.M. Various Models '85/
UNIT PACKAGE 50

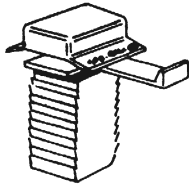
**89-6590**

Replaces: 20556524
**RETAINER-REAR WINDOW
 SPOILER MouldING**
 Plastic
 Firebird '85/
UNIT PACKAGE 50

**99-8405**

RETAINER-MouldING
 Hole: 1/2" x 7/32"
 Plastic
 Used on Various Mouldings
 Formerly 93-7101
 G.M. '62 - '66
UNIT PACKAGE 25

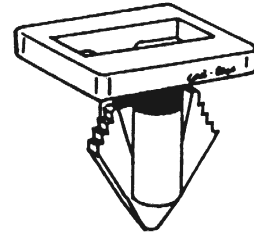
**88-6470**

Replaces: 20653699
RETAINER-UPPER DOOR PANEL TRIM
 M4.2 Screw, Plastic
 G.M. Corsica '87/
UNIT PACKAGE 25

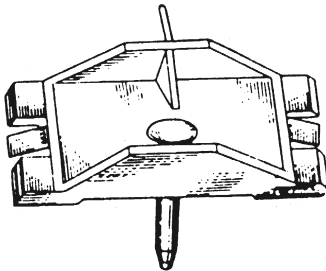
**77-4592**

Replaces: 10001135
RETAINER-MouldING
 Pontiac '78/
UNIT PACKAGE 25

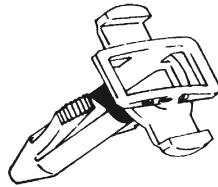
**95-7391**

Replaces: 16611744
**RETAINER-LOWER BODY SIDE
 MouldING**
 Plastic
 (Part of 16616072 Clip Assy.)
 Pontiac Grand Am '92/
UNIT PACKAGE 15

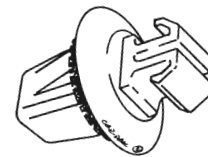
**99-7988**

Replaces: 90467-11063, 88970493,
 77553-65D00
**RETAINER-ROCKER PANEL MouldING,
 WHEEL FLARES**
 Plastic - Hole: M9
 Toyota '90/ & Pontiac Vibe 2003/
 Suzuki Gr. Vitera '99-2004
UNIT PACKAGE 15

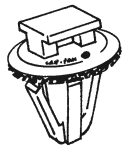
**99-8171**

Replaces: 62955-12010, 94848834
**RETAINER-RADIATOR GRILLE, TRUNK
 PANEL, BACK GLASS LOUVER**
 Plastic - with sealer
 Hole: M8, Flange: 15MM, Head: 8MM Sq.
 Toyota Corolla, Rav4 '88/ , Matrix 2003/
 Lexus ES300 '92-'96 & Pontiac Vibe 2003/
UNIT PACKAGE 10

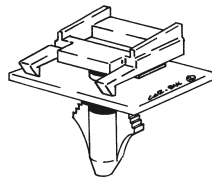
**97-7663**

Replaces: 16616138, 22658182
CLIP- ROCKER PANEL MouldING
 Plastic
 Hole Dia: M8.75
 G.M. "J" Body '95/
UNIT PACKAGE 25

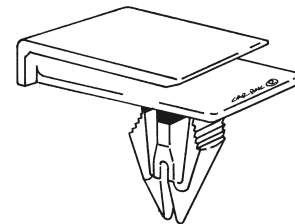
**99-7984**

Replaces: 22603384
RETAINER-ROCKER PANEL MouldING
 Plastic
 G.M. "N" Body '99
UNIT PACKAGE 15

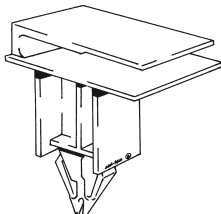
**99-8097**

Replaces: 10411395, 10431761, 10363352
RETAINER - ROCKER PANEL MouldING
 Plastic
 Hole: M12, O/L: 40MM
 G.M. 'W' Body 2000, Saturn Aura 2007/
UNIT PACKAGE 15

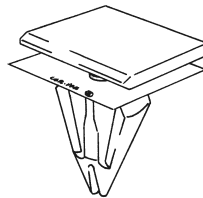
**99-8119**

Replaces: 25693852
CLIP - ROCKER MouldING
 Plastic
 Hole: M11
 G.M. all lines 'H', 'K', 'E',
 'W' & 'G' Bodies '95/
UNIT PACKAGE 15

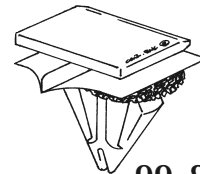
**99-8244**

Replaces: 11518357, 10443956
**RETAINER - FENDER, SIDE & RKR
 MouldING, FRONT BUMPER,
 CARGO BOX**
 Plastic w/seal
 Hole: M10
 Cadillac Escalade, G.M. C/K Trucks &
 'W' Bodies 2000/ & Ford Edge/MKX 2007/
UNIT PACKAGE 25

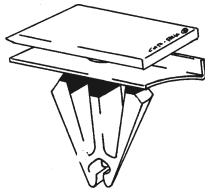

99-8447

Replaces: 10323057
RETAINER-ROCKER MOULDING
 Plastic
 Hole: M9, Upper Hd: 12x20MM,
 P.R.: 4MM, Stem Lgth: 14.3MM
 Pontiac Grand Prix 2004 & G6 2005/
 UNIT PACKAGE 15

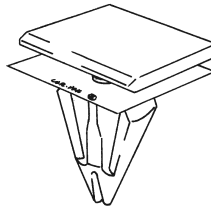

99-8402

Replaces: 25724529, 25742293
CLIP-ROCKER MLD, FRT. BUMPER
 & GRILLE - Plastic
 Hole Dia.: M10
 G.M. 'G' Bodies, Chevrolet Avalanche,
 Cadillac CTS, SRX & Escalade 2000/
 UNIT PACKAGE 15

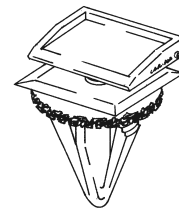

99-8268

Replaces: 10242285, 10297369, 10308019
CLIP - ROCKER MOULDING
 Plastic
 G.M. Pontiac 'B' & 'U' Bodies '97/
 UNIT PACKAGE 15

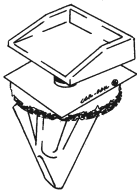

99-8267

Replaces: 10442914, 10300287
RETAINER - FENDER FLARE MOULDING
 Plastic w/seal
 Hole: M10
 Buick Rendezvous 2002
 UNIT PACKAGE 15

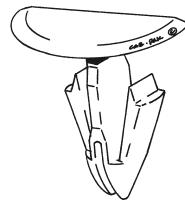

99-8325

Replaces: 10308063
RETAINER - ROCKER MOULDING
 Plastic
 Hole: M10-11, O/L: 22.5MM
 Buick Rendevous & Pontiac Aztek 2001/
 UNIT PACKAGE 15

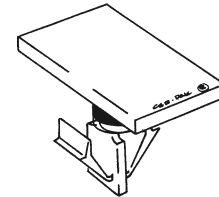

99-8449

Replaces: 25718851
RETAINER-BODY SIDE MOULDING
 Plastic
 Hole: M7x12 Slot, Head: 14x20MM,
 Stem Lgth: 9.5MM, P.R.: 4MM
 Cadillac STS & SLS '98/
 UNIT PACKAGE 25

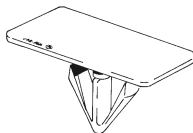

99-8388

Replaces: 10431524
RETAINER-ROCKER MOLDING
 Plastic
 Hole: M7, Head: 19.2x30MM,
 P.R.: 43.8MM
 G.M. 'W' Bodies 2000/
 UNIT PACKAGE 15

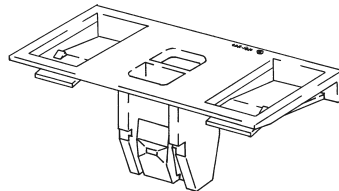

99-8120

Replaces: 25648693
CLIP - ROCKER MOULDING
 Plastic
 Hole: 9 x 14MM
 Cadillac Seville Models '98/
 UNIT PACKAGE 10

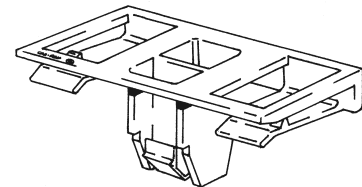

99-8252

Replaces: 25722671
RETAINER-ROCKER MOULDING
 Plastic
 Hole: M11
 Cadillac Deville & Olds Aurora 2000/
 UNIT PACKAGE 10

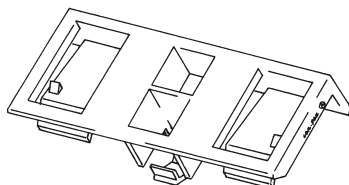

99-8269

Replaces: 25691949, 25704001
CLIP - ROCKER MOULDING
 Plastic
 G.M. 'C', 'H' & 'K' Bodies 2000/
 UNIT PACKAGE 10



99-8358

Replaces: 88970495, 88973654,
 76924-02010, 76924-52021
RETAINER - ROCKER MOULDING, Plastic
 Hole: M21.5, Flange: 32MM,
 O/L: 12.5MM,
 Pontiac Vibe 2003 & Toyota 2003/
 Scion 2004/
 UNIT PACKAGE 25

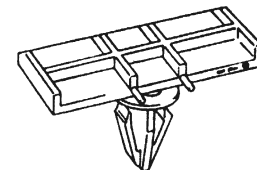

96-7556

Replaces: FITZ-7810182-A, 12532109
RETAINER-ROCKER PANEL
 GROUND EFFECTS
 Hole: M9
 Ford Explorer & Pick-ups '91/
 G.M. 'F' Bodies '93/
 UNIT PACKAGE 25

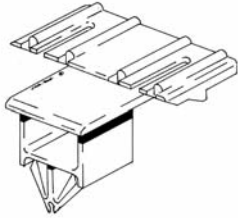
**99-8673**

Replaces: 10384814
RETAINER-Rocker Molding
 Plastic-White
 Hole: M10
 Buick Lucerne 2006
UNIT PACKAGE 10

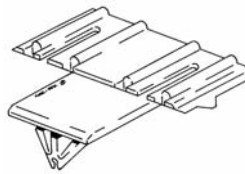
**99-8674**

Replaces: 15236893
RETAINER-Rocker Molding
 Plastic-Black
 Hole: M9
 Buick Lucerne 2006
UNIT PACKAGE 10

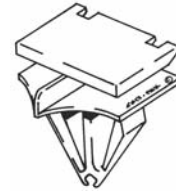
**99-8675**

Replaces: 15236894
RETAINER-Rocker Molding
 Plastic
 Hole: M9
 Buick Lucerne 2006
UNIT PACKAGE 10

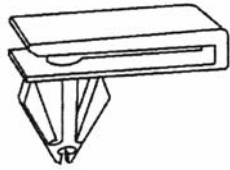
**99-8664**

Replaces: 15221959
RETAINER-ROCKER PANEL
 Plastic
 Hole: M10, Head: 15x29MM,
 Stem Lgth: 15MM
 Chevrolet Cobalt, HHR 2005/
 & Pontiac G5 2007
UNIT PACKAGE 15

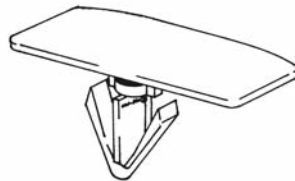
**99-8559**

Replaces: 10437565, 10352803
RETAINER-ROCKER MOULDING
 Plastic
 Hole: M7, Head: 12x33MM,
 Stem Lgth: 17.5MM
 Chevrolet Impala ('W' body) 2000/
UNIT PACKAGE 10

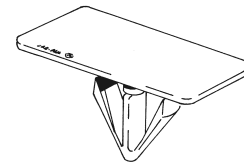
**99-8571**

Replaces: 10426887, 10431503, 10352809
RETAINER-ROCKER MOULDING
 Plastic
 Hole: M7, Head: 17x33MM,
 P.R.: 5.5-6.5MM
 G.M. 'W' Bodies 2000/
UNIT PACKAGE 25

**99-8688**

Replaces: 11589176
RETAINER-ROCKER MOULDING
 Plastic
 Hole: M9, Top: 19x26MM,
 Bottom: 15x25MM
 Chevrolet Malibu 2004/
UNIT PACKAGE 15

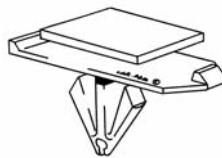
**99-8744**

Replaces: 11562563
RETAINER-Rocker Moulding
 Plastic
 Hole: M10, Upper Hd: 12x20MM,
 P.R.: 4MM, Stem Lgth: 15MM, O/L:
 21MM
 Chevrolet Malibu 2008/
UNIT PACKAGE 15

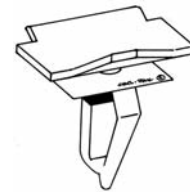
**99-8773**

Replaces: 11588818, 11561329
**RETAINER-FRONT BUMPER
 & ROCKER MOULDING**
 Plastic
 Hole: M10
 Chevrolet Corvette & Cadillac STS 2005/
UNIT PACKAGE 10

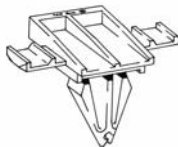
**99-8589**

Replaces: 15116576, 1151665, 15282120
RETAINER-BODY SIDE MOULDING
 Plastic
 Hole: M10, Head: 16x38MM,
 Stem Lgth: 15MM
 Buick Terraza, Chevrolet Uplander,
 Pontiac Montana SV6, Saturn Relay 2005/
UNIT PACKAGE 15

**99-8588**

Replaces: 15127746
RETAINER-BODY SIDE MOULDING
 Plastic
 Hole: M9, Head: 12x20MM,
 Stem Lgth: 11MM
 Buick Terraza, Chevrolet Uplander,
 Pontiac Montana SV6, Saturn Relay 2005/
UNIT PACKAGE 15

**99-8572**

Replaces: 5480852
RETAINER-ROCKER MOULDING
 Plastic w/Seal
 Hole: M9
 Chevrolet Equinox & Pontiac Torrent 2005/
UNIT PACKAGE 15

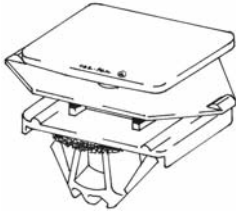

99-8622

Replaces: 11561491, 15872008
RETAINER-ROCKER MOLDING
 Plastic
 Hole: M15, Stem Lgth: 11.3MM
 (Replaces original Stem Lgth. of 19MM)
 Chevrolet Equinox & Pontiac Torrent 2006
UNIT PACKAGE 10

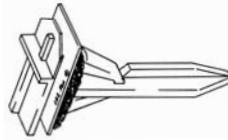

99-8745

Replaces: 11589244, 11569973
RETAINER-Rocker Mldg.,
 Spoiler, Interior Roof Trim
 Yellow Plastic w/Seal
 Hole: M9, Upper Hd: 12x21.5MM,
 O/L: 42.0MM
 G.M. Trucks. Equinox & Torrent 2006/
 Enclave, Acadia & Outlook 2004/
UNIT PACKAGE 10

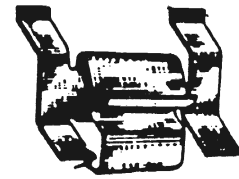

74-4052

Replaces: 1654500
CLIP-REAR SIDE
INNER MOULDING
 Chevrolet '75
UNIT PACKAGE 100

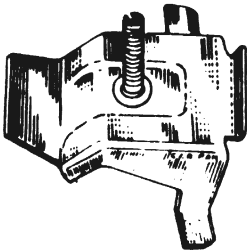

72-3669

RETAINER-MOULDING FASTENER
 Hood & General Purpose
 Ford, G.M. Products
UNIT PACKAGE 50



78-4889

Replaces: 20119600
CLIP-FINISHING MOULDING
 LIFT OFF PANEL OPENING
 G.M. '79/
UNIT PACKAGE 50



70-3413

Replaces: 9835089
CLIP-BODY SIDE MOULDING
 G.M. '71 - '72
UNIT PACKAGE 50



90-6802

Replaces: 20730531
NUT-BODY SIDE MOULDING
 Tubular Plastic
 Hole: 3/8"
 Pontiac & Olds "H" Bodies '87/
UNIT PACKAGE 25



87-6311

Replaces: 20465395
BLIND RIVET-SUPER TOUGH NYLON
 Hole: 5M, Panel Range: 3-4MM
 Head Dia.: 9MM, Plastic
 Window Reg. Attachments
 G.M., Cadillac
UNIT PACKAGE 25

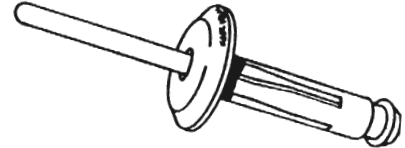

89-6627

Replaces: 10109689 & 12337915
BLIND RIVET-SUPER TOUGH NYLON
 Wheel House, Door Panel Moulding
 & General Usage
 Hole Dia.: M7.0 - 7.5, P.R.: 2.5 - 6.0MM
 Head Dia.: 18MM
 G.M. "L" Body '87/
UNIT PACKAGE 25

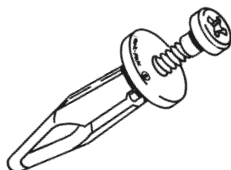

99-7934

Replaces: 10246149
RIVET-SCREW TYPE
 ROCKER PANEL MOULDING, GRILLE
 Hole:M6, Flange:11MM, PR: 4.5-7.5MM
 G.M. "N" Body '99/ & S/T Truck '95/
UNIT PACKAGE 25



99-8357

Replaces: 88970494, 88973676,
 90467-07168
RIVET - PIN DRIVE (TWIST TO RELEASE)
 Rocker & Garnish Moulding
 Plastic
 Hole: M7, Flange: 20MM,
 Stem Lgth: 8.5MM, P.R.: 5MM
 Pontiac Vibe 2003 & Toyota/Lexus 2000/
UNIT PACKAGE 15

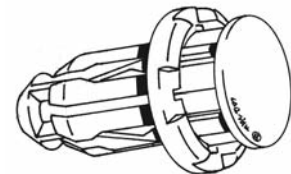

99-8558

Replaces: 5480772
RIVET-DRIVE TYPE,
 Lower Rocker Moulding
 Plastic
 Hole: M15, Flange: 22MM, O/L: 26.5MM
 Chevrolet Equinox 2005
UNIT PACKAGE 10

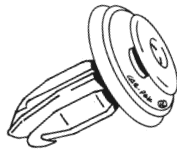

99-8360

Replaces: 94178705, 94858299, 90467-10161
RETAINER - ROCKER MOULDING
 Plastic
 Hole: M8.5, Upper Hd: 13MM, O/L: 20MM,
 Trim Thk: 2.6MM, P.R.: 0.7-1.6
 Pontiac Vibe 2003/
 Lexus & Toyota '98/, Scion 2004/
 UNIT PACKAGE 50

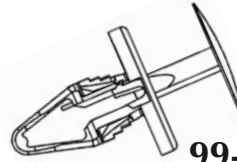

99-8696

Replaces: 11589289, W713610-S300, 6508863AA
RIVET-DRIVE TYPE, Flares, Cowl,
 RKR Moulding., Front Bumper, Plastic
 Hole: M6.25-6.53, Flange: 18MM,
 Stem Lgth: 17.5MM, P.R.: 2-4MM
 G.M. Equinox & Torrent 2007,
 Buick Enclave, Saturn '91/
 Ford Focus 2008/ & Dodge PU 2009/
 UNIT PACKAGE 25

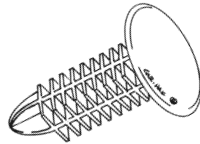

99-8398

Replaces: 88970656, 90467-05020
RETAINER-ROCKER PANEL &
INTERIOR TRIM
 Plastic
 Hole: M5, Head:16MM, Stem Lgth: 16MM, P.R.: 1.5-10MM
 Pontiac Vibe 2003,
 Totota Celica '94-99 & Lexus RX300 '99/
 UNIT PACKAGE 50

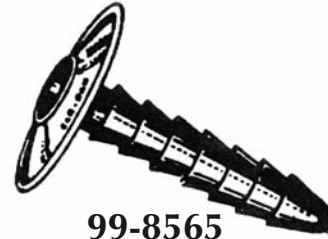

99-8565

Replaces: 4001934, 7642589, W709883-S300
RETAINER-FIRE WALL INSULATOR, ROCKER MOLDING
 Plastic
 Formerly 72-3642
 Hole: M9.65, Head: 25.4mm, Stem Lgth: 36MM
 G.M. '68/ & Ford Mustang 2005/
 UNIT PACKAGE 50

SATURN

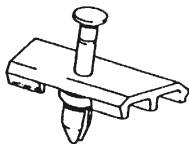

92-7042

RETAINER-ROOF DRIP MOULDING
 Plastic
 Saturn '91/
 UNIT PACKAGE 25

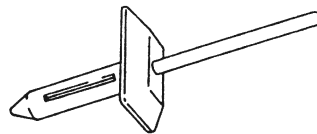

92-7041

BLIND RIVET NYLON-DOOR
WEATHERSTRIP RETAINER
 Hole: M4, P.R.: 2.5 - 5.5MM
 15MM x 8MM Head Rectangle
 Saturn '91/
 UNIT PACKAGE 50

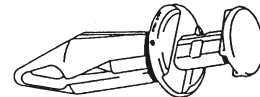

92-7025

Replaces: 20730531, 21077123,
 W705436-S300, 6509103AA
RIVET-DRIVE TYPE, COWL VENT, GRILLES,
BUMPERS & FENDERS SHIELDS
 Plastic
 Hole: M6, Flange: 15MM, P.R.: 5MM
 G.M., Saturn '91-2007, Ford 2002/
 Dodge Journey 2009/
 UNIT PACKAGE 25

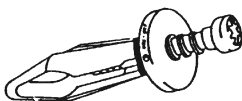

92-7044

RIVET-SCREW TYPE DOOR & REAR DECK
SPEAKERS TORX DRIVE
 Hole: M6, Flange: 11MM, P.R. 5-10MM
 Plastic
 Saturn '91/
 UNIT PACKAGE 25

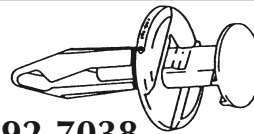

92-7038

Replaces: 5485676, 15691478,
 15969147, 21030249, N807389-S,
 W711035-S300, 6503598
RIVET-DRIVE TYPE FENDER APRON,
BUMPERS & GRILLES
 Plastic
 Hole: M8, Flange: 20MM, P.R. 3-8MM
 G.M. Saturn '91/, G.M. C/K Truck '99/ &
 Hummer, Chrysler '95-2000, Ford 2006/
 Dodge Nitro 2007/ Jeep 2005/
 UNIT PACKAGE 50

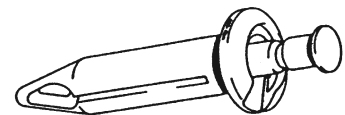

92-7040

RIVET-DRIVE TYPE ROCKER PANEL TO
UNDERBODY
 Plastic
 Hole: M8, Flange: 15MM, P.R. 12-16MM
 G.M. Saturn '91/
 UNIT PACKAGE 25

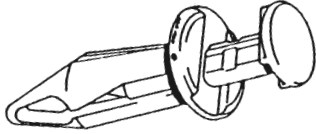
**92-7039**

Replaces: 21075686, 11561878,
F3LY-14570-B

**RIVET-DRIVE TYPE WHEELWELLS, FRONT
BUMPER, COWL VENT, Plastic**
Hole: M8, Flange: 15MM, P.R. 3-8MM
G.M. Saturn '91/, Grand Prix 2004
Corvette '97/
Ford Explorer/Mountaineer '95/
UNIT PACKAGE 50

**92-7066**

**RIVET-DRIVE TYPE
O/S DOOR HANDLES**
Hole: 3/16"
Plastic
Saturn '91/
UNIT PACKAGE 25

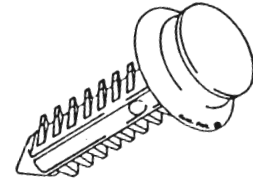
**92-7043**

Replaces: N802900-S
& 21042058
RETAINER-DOOR TRIM PANEL
Plastic
Hole: M7
Saturn '91/
UNIT PACKAGE 50

**95-7393**

Replaces: 21094146,
21110201 & 6501301

**RETAINER-TRIM PANELS, FRONT
BUMPERS**
Hole: M7.9, Head: 19MM,
Stem Length: 23MM
Black Plastic
G.M. Saturn '91/, C/K Trucks '99/
Chrysler Mini Vans '87/
UNIT PACKAGE 25

**99-8795**

Replaces: 15989431
RETAINER-HOOD INSULATOR
Plastic, Textured
Hole: M7.1, Head: 28MM,
Stem Lgth: 16MM, O/L: 20.5MM,
P.R.: 2.5-4.5MM
G.M. Enclave, Traverse, Acadia &
Saturn Outlook 2007/
UNIT PACKAGE 25

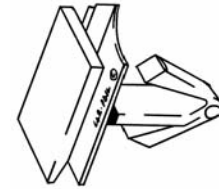
**99-8739**

Not Supplied by O.E.
RETAINER-ROCKER MOULDING
Plastic-Black
Hole: M9, Upper Head: 12x20MM,
P.R.: 8MM, Stem Lgth: 14.8MM
Saturn Aura 2007/
UNIT PACKAGE 15

**95-7474**

Replaces: 21036860, 25612368 &
N807673-S
**RIVET-DRIVE TYPE
DASH & TAILGATE**
Hole: M7, Head: 14MM
Black Plastic
Saturn '95/ & Ford 'F' Trucks '97/
UNIT PACKAGE 15

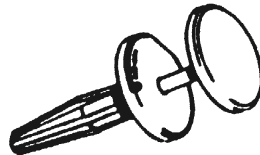
**95-7475**

**RIVET-DRIVE TYPE ROCKER PANEL &
WHEEL HOUSING COVER**
Black Plastic
Hole: M6.5, Head: 14MM
Saturn '96
UNIT PACKAGE 25

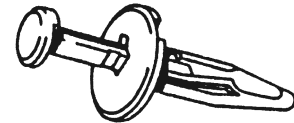
**95-7476**

Replaces: 21077131
RIVET-DRIVE TYPE
Front & Rear Fascia
Black Plastic
Hole: M11.5, Washer: 30MM, P.R.: 26MM
Saturn '91/ & Various G.M. Models
UNIT PACKAGE 10

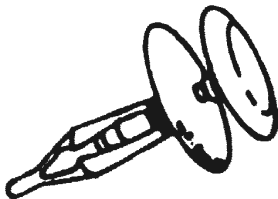
**95-7477**

Replaces: 21095797, 11519807
RIVET-DRIVE TYPE
REAR BUMPER FILLER
Hole: M8, Head: 20MM
Black Plastic
Saturn '96/
UNIT PACKAGE 15

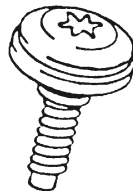
**92-7001**

BOLT-TORX DRIVE w/DOG POINT
M6 - 1.0 x 20MM
T-30 Torx Drive
18MM Plastic Washer
9.5MM x 5MM Shoulder, Finish: Black
G.M. Saturn '91/
UNIT PACKAGE 50



PONTIAC LeMANS



89-6612

Replaces: 90248375
RETAINER-REAR COMPARTMENT TRIM
 Gray Plastic
 Hole: M6.3, Head: 12MM
 G.M. Pontiac LeMans '87/
UNIT PACKAGE 50



86-6182

Replaces: 94797292
RETAINER-REAR COMPARTMENT TRIM
 Tan Plastic
 Hole: M6.3, Head: 12MM
 G.M. Pontiac LeMans '87/
UNIT PACKAGE 50



86-6183

Replaces: 9479293
RETAINER-REAR COMPARTMENT TRIM
 Gray Plastic
 Hole: M6.3, Head: 12MM
 G.M. Pontiac LeMans '87/
UNIT PACKAGE 50

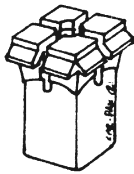

89-6613

Replaces: 90186852
GROMMET-COWL VENT LOUVER
 Plastic
 G.M. Pontiac LeMans '88/
UNIT PACKAGE 25

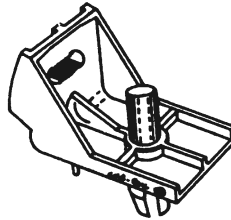

86-6180

Replaces: 90244561
RETAINER
 Plastic
 G.M. Pontiac LeMans '87/
UNIT PACKAGE 10

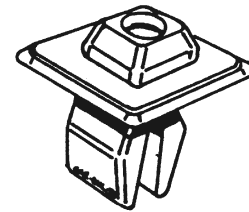

86-6179

Replaces: 90186857
GROMMET
 Plastic
 Hole: 7MM Sq., Screw: M5
 G.M. Pontiac LeMans '87/
UNIT PACKAGE 25

GEO

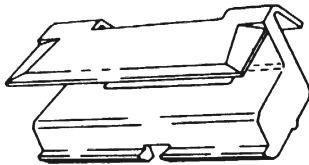

90-6770

Replaces: 94467458
CLIP-WINDSHIELD
 MOULDING
 Plastic
 G.M. Geo Storm '90/
UNIT PACKAGE 10



90-6813

Replaces: 94113207
RETAINER-COWL COVER
 Plastic
 G.M. Spectrum '85/
UNIT PACKAGE 15

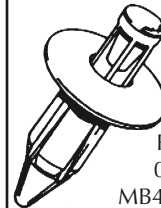

90-6806

Replaces: 96057846
 09409-07308-281,
 MB475404, 90467-07076
RIVET-DRIVE TYPE (Removeable)
 COWL, FRONT BUMPER, Plastic
 Hole: M6, Washer: 15MM, P.R.: 2-5MM
 Toyota Rav 4, G.M. Geo Tracker '89/
 Chrysler & Mitsubishi '95/
 Suzuki Sidekick '89/
UNIT PACKAGE 10

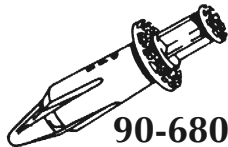

90-6807

Replaces: 96057847
 09409-07313, 90467-07313
RIVET-DRIVE TYPE
 RADIATOR GRILLE RETAINER,
 DOOR PANEL
 Hole: M7, Washer: 11MM, P.R.: 7-10MM
 Plastic-Textured
 Toyota 4 Runner & Camry
 G.M. Geo Tracker '89/
 Suzuki Sidekick '89/
UNIT PACKAGE 10

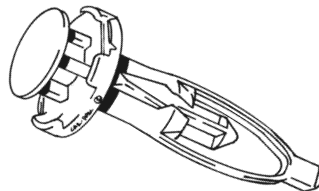

96-7606

Replaces: 52161-16010
RETAINER- FRONT-BUMPER
 Plastic-Black
 Hole Dia: M9, Flange Dia: 18MM
 Stem Lgth: 28MM
 Toyota Tercel '95/
UNIT PACKAGE 5

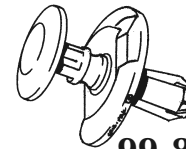

99-8103

Replaces: 90467-07164,
 09409-07332, 30020637
RIVET-DRIVE TYPE
 Grille, Bumper, Fender Apron/Flare-Plastic
 Hole: M7, Flange: 20MM,
 Stem Lgth: 10MM
 Toyota Camry, MR2, Sienna & Echo '97/
 Suzuki Gr. Vitera/Vitera, XL7, Ari '99/, G.M.
 Tracker '99/
UNIT PACKAGE 10



99-8302

Replaces: 30000784, 09409-05309-5ES
RETAINER - COWL VENT
 Plastic-Textured Head
 Hole: M5, Head: 14MM, P.R.: 8.5MM
 Chevrolet Tracker '99/ & Suzuki Vitara '99/
 UNIT PACKAGE 25



99-8301

Replaces: 96057293, 83943-86000
RETAINER - COWL VENT
 Plastic
 Hole: M7, Head: 12 x 15MM,
 P.R.: 3MM
 Chevrolet Tracker '99/ & Suzuki Vitara '99/
 UNIT PACKAGE 25

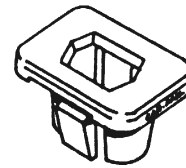

89-6679

Replaces: 94178927
RETAINER-RADIATOR GRILLE
 Black Plastic
 G.M. Spectrum '85 - '86
 UNIT PACKAGE 15



89-6680

Replaces: 94141978
GROMMET-HEADLAMP
 DOOR TO FENDER
 Hole: 9MM x 12MM
 Screw: M5
 Plastic
 G.M. Spectrum '85 - '86
 UNIT PACKAGE 10

**LOOKING FOR A COST
 RECOVERY SYSTEM?
 GO TO:
www.thepro.com**

FIERO

86-6169

Replaces: 20338249
BLOCK-BODY PANEL MOUNTING PAD
 (Mill & Drill Type-Small) Used To Locate & Support
 Exterior Body Panels To Space Frame For Perfect Fit.
 Base 1 x 1-3/4";
 Mill Section 25/32" Sq. x 3/8" Thick
 Pontiac Fiero '84/
 UNIT PACKAGE 10

86-6170

Replaces: 20381216
BLOCK-BODY PANEL MOUNTING PAD
 (Mill & Drill Type-Large) Used To Locate & Support
 Exterior Body Panels To Space Frame For Perfect Fit.
 Base 1-3/16 x 2";
 Mill Section 1" Sq. x 7/16" Thick
 Pontiac Fiero '84/
 UNIT PACKAGE 10

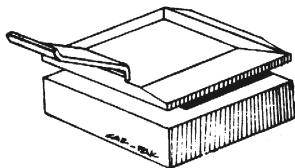
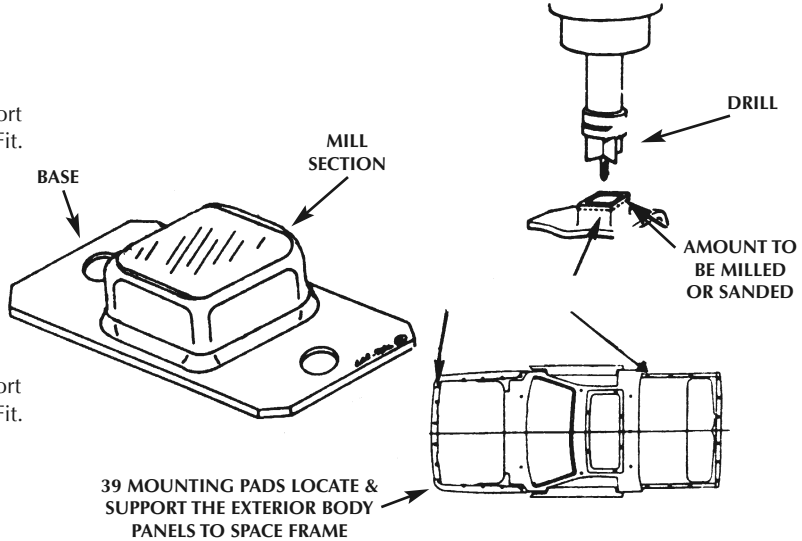

83-5662

Replaces: 204593328 & 20505073
BLOCK-EXTERIOR TRIM
 G.M. "P" Car '84/
 UNIT PACKAGE 25



85-5926

Replaces: 20468982
TEE NUT M6-FRONT DOOR OUTER
 LOWER PLATE
 G.M. "P" Body Fiero '84/
 UNIT PACKAGE 10



85-5925

Replaces: 20468981
TEE NUT M6-FRONT DOOR OUTER
 UPPER PLATE
 G.M. Fiero "P" Body '84/
 UNIT PACKAGE 10

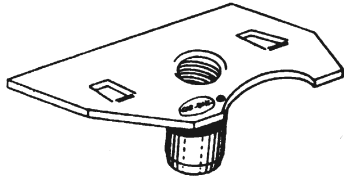

85-5919
 Replaces: 20459360
**TEE NUT-FRONT DOOR
 OUTER PANEL**
 M6
 G.M. Fiero "P" Body '84/
UNIT PACKAGE 25



85-5942
 Replaces: 2045900
**RETAINER-PUSH IN TYPE
 BODY SIDE MOULDING**
 Hole: M6
 Plastic
 G.M. Fiero "P" Body '84/
UNIT PACKAGE 50



85-5943
 Replaces: 20363491
**RIVET-DRIVE TYPE BODY SIDE
 MOULDING**
 Plastic
 G.M. Fiero "P" Body '84/
UNIT PACKAGE 50

GARNISH / HEADLINER AND INTERIOR MOULDINGS

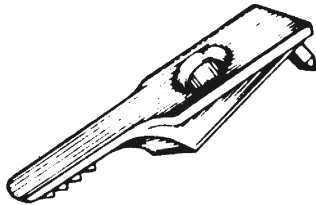

68-3190
INSERT-COAT HOOK
 Nylon
 G.M. & Ford Cars '68 - '72
UNIT PACKAGE 50

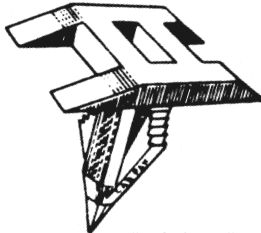

74-3954
 Replaces: 9899423
**RETAINER-ROOF INNER SIDE MOULDING
 (Headliner)**
 G.M. Cars '71 - '76
UNIT PACKAGE 100

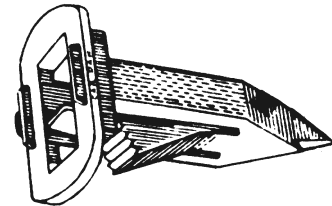

73-3819
 Replaces: 9617200
RETAINER-HEADLINING MOULDING
 G.M. Cars '72 - '76
UNIT PACKAGE 100

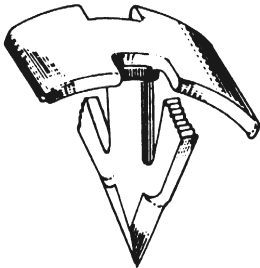

72-3748
 Replaces: 9660413
RETAINER-HEADLINING
 G.M. '73 - '75
UNIT PACKAGE 50

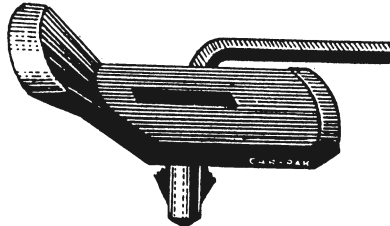

73-3806
 Replaces: 9626535
**RETAINER-REAR WINDOW
 LOWER GARNISH MOULDING**
 Buick, Olds '73
UNIT PACKAGE 50

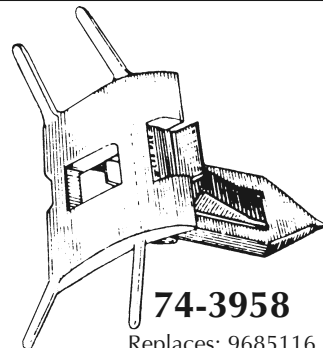

74-3958
 Replaces: 9685116
**RETAINER-ROOF INNER PANEL
 SIDE MOULDING**
 Chevrolet, Buick, Olds, Pontiac '74 - '76
UNIT PACKAGE 50

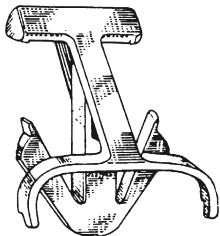

75-4110
 Replaces: 1707232
**RETAINER-ROOF INNER PANEL
 SIDE MOULDING**
 G.M. Cars '75
UNIT PACKAGE 50

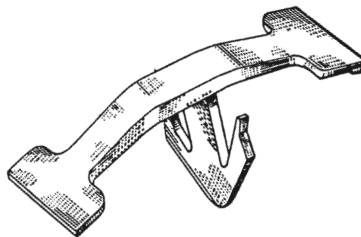

75-4179
 Replaces: 1704611
RETAINER-HEADLINING MOULDING
 G.M. Cars '75 - '76
UNIT PACKAGE 50

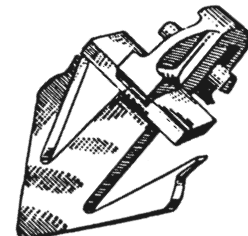

75-4186
 Replaces: 1708675
**RETAINER-HEADLINING
 MOULDING**
 G.M. '76
UNIT PACKAGE 50

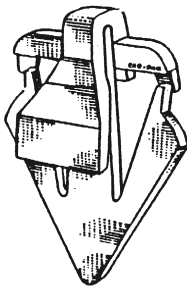
**75-4178**

Replaces: 20005924
RETAINER-HEADLINING MOULDING
 G.M. Full Size Cars '76
UNIT PACKAGE 50

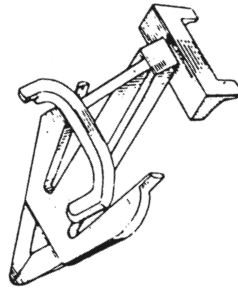
**77-4667**

Replaces: 1705716
RETAINER-HEADLINING MOULDING
 Cadillac Seville '76/
UNIT PACKAGE 25

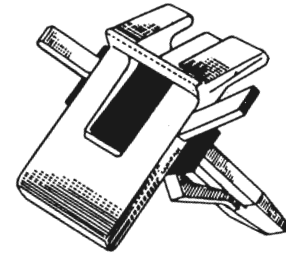
**76-4374**

Replaces: 20010348
RETAINER-HEADLINING GARNISH
MOULDING
 G.M. '77/
UNIT PACKAGE 50

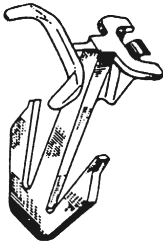
**77-4623**

Replaces: 20009775
RETAINER-HEADLINING GARNISH
MOULDING
 G.M. '77/
UNIT PACKAGE 50

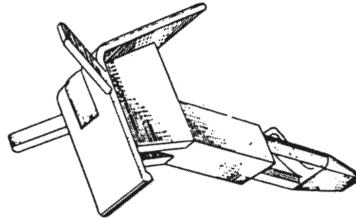
**78-4738**

Replaces: 20022349
RETAINER-HEADLINING MOULDING
 G.M. '78/
UNIT PACKAGE 25

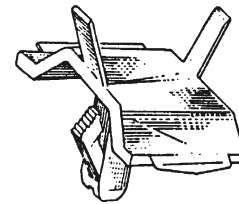
**78-4951**

Replaces: 20073477
RETAINER-HEADLINING MOULDING
 G.M. '78/
UNIT PACKAGE 50

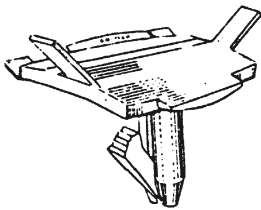
**78-4759**

Replaces: 20074325
RETAINER-2-DOOR ROOF PANEL COVER
FRONT FINISH MOULDING
 Pontiac LeMans '78/
UNIT PACKAGE 50

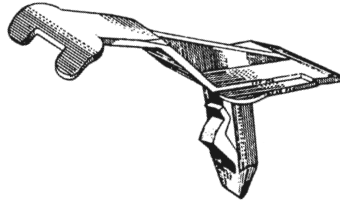
**79-5128**

Replaces: 3074737
RETAINER-BACK BODY FINISH
UPPER MOULDING
 Station Wagon
 G.M. "A" Bodies '80/
UNIT PACKAGE 25

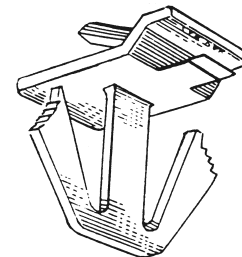
**79-5125**

Replaces: 20167448
RETAINER-HEADLINING MOULDING
 G.M. '80/
UNIT PACKAGE 25

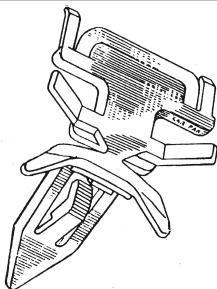
**79-5124**

Replaces: 20180178
RETAINER-HEADLINING BACK LOWER
WINDOW MOULDING
 Buick & Olds '80/
UNIT PACKAGE 25

**91-6935**

Replaces: 20632190
RETAINER-REAR WINDOW
GARNISH MOULDING
 Upper & Side
 Plastic
 G.M. '80/
UNIT PACKAGE 10

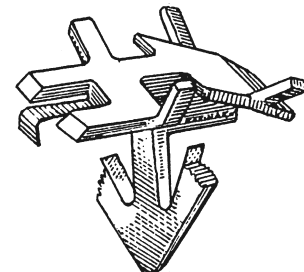
**80-5176**

Replaces: 20178574
RETAINER-HEADLINING MOULDING
 G.M. '80/
UNIT PACKAGE 50

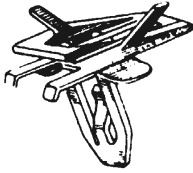
**92-7045**

Replaces: 20058837
**RETAINER-UPPER WINDSHIELD
 GARNISH MOULDING**
 Plastic
 Chevrolet, Olds, Buick, Pontiac
 "A" Bodies '78/
UNIT PACKAGE 10

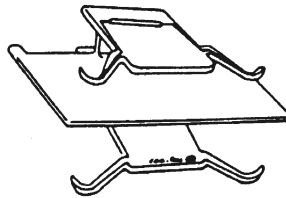
**88-6475**

Replaces: 20610644
**CLIP-HEADLINER SIDE FRONT DOOR &
 WINDOW FRAME**
 Plastic
 G.M., Buick, Olds "C" Body '85/
UNIT PACKAGE 25

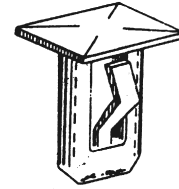
**94-7224**

Replaces: 20359997
RETAINER-HEADLINING MOULDING
 Formerly 82-5493
 Plastic
 G.M. '82 - '92
UNIT PACKAGE 15

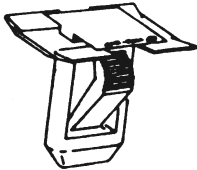
**88-6466**

Replaces: 20462090
**RETAINER-GARNISH MOULDING
 INTERIOR**
 Plastic
 G.M. "C, E, F, H, K" Bodies '82/
UNIT PACKAGE 25

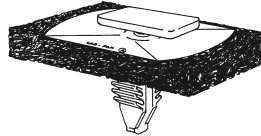
**99-8226**

Replaces: 16659130, 25672428
**RETAINER -'C' & 'H' PILLAR
 MOULDINGS, HEADER PANELS,
 REAR BUMPER PANEL
 PLUG & DOOR SILL PLATES**
 Plastic w/seal
 Slot: 7x14MM, Flange: 20x36MM
 P.R.: 1.9MM
 G.M. 'C', 'G', 'H' & 'K' Bodies '93/
UNIT PACKAGE 15

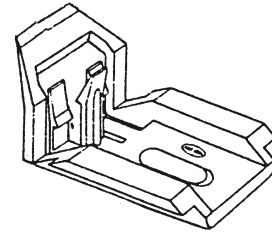
**84-5831**

Replaces: 20325563
CLIP-FILLER PANEL REAR WINDOW
 Plastic
 Grand Prix, Regal, Malibu
 Monte Carlo & Cutlass '82/
UNIT PACKAGE 25

**78-4815**

Replaces: 10001784
**RETAINER-INSTRUMENT PANEL
 COVER**
 Pontiac '78/
UNIT PACKAGE 50

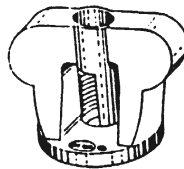
**85-5962**

Replaces: 20180178
**WING NUT-REAR SPEAKER
 COVER RETAINING**
 Plastic
 6MM
 G.M.
UNIT PACKAGE 25

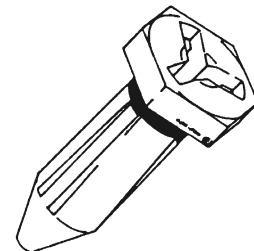
**91-6985**

Replaces: 22552707
RETAINER-RETAINER RADIO MOULDING
 Plastic
 G.M. "J" Bodies
UNIT PACKAGE 15

**94-7222**

Replaces: 10078274
RETAINER-PUSH-IN TYPE
 Black Plastic
 Hole: M4.5, Head Dia.: 10MM
 P.R.: 6-13MM
 G.M. & General Purpose
UNIT PACKAGE 25

**94-7223**

Replaces: 8732474
RETAINER
 Black Plastic
 Hole: M3, Head Dia.: 10MM
 Stem Length: 15MM
 G.M. '76/, General Purpose
UNIT PACKAGE 50

**96-7504**

Replaces: 10140336, N808552-S
**RETAINER-DOOR PANEL &
 WHEEL HOUSE**
 Hole: 9/32", O/L: 1-5/8"
 Head: 25/32"
 Black Plastic
 G.M. "U" Van Bodies '90/, Ford
UNIT PACKAGE 50



98-7887

Replaces: 20227160
RETAINER-INTERIOR TRIM
 Plastic - Textured Head
 Hole: 1/4", Hd: 23/32", P.R: 9/32"
 Formerly 81-5454
 G.M. Car & Truck '80/ & Japanese Cars
UNIT PACKAGE 25



99-8154

Replaces: 6503943, N806113-S, 16674629
RETAINER-INTERIOR TRIM PANELS
 Plastic
 Hole: M6.3, Head: 25MM,
 Stem Length: 16MM, O/L: 18MM
 Chrysler Dakota, Pick-Ups &
 PT Cruisers '94/
 G.M. Impala & Monte Carlo 2000/
UNIT PACKAGE 50

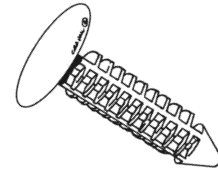

99-8111

Replaces: 15975244
RETAINER-HEADLINER, SIDE MARKER
WIRING, AIR CLEANER HOUSING
 Hole: M7, O/L: 29MM, Head: 19MM
 Plastic
 G.M. C/K & S/T Trucks '94/
UNIT PACKAGE 25

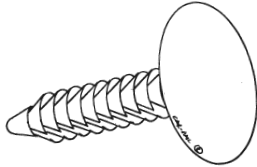

99-8399

Replaces: 10241518, 10242316,
 10249241, 10280874
RETAINER-HEADLINER &
LIFTGATE SILL PLATE
 Plastic-Grey (Paint to Match), Textured
 Hole: M7, Head: 26MM, Stem Lgth: 28MM,
 P.R.: 3.5-20MM, O/L: 30MM
 G.M. Cars '92/ & Venture Van 2002/
UNIT PACKAGE 25

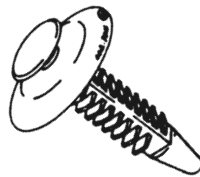

96-7579

Replaces: 10158124
RETAINER-INTERIOR TRIM
 White Plastic
 Hole: M7, Head Dia.: 13MM
 Barb Length: 13MM, O/L 31MM
 G.M.'92/
UNIT PACKAGE 25



99-8117

Replaces: 11517824, 21035345
RIVET - DRIVE TYPE, COWL, MLDG.
LAMPS, INSTRUMENT PANEL
 Plastic, Push To Release
 Hole: M7, Head: 16MM, P.R.: 4.5-6.5
 G.M. '92/, Saturn '93/ & Cadillac 'K' & 'E'
 Body '99/
UNIT PACKAGE 10

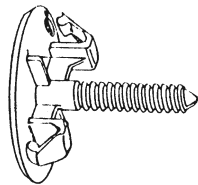

85-5974

Replaces: 20432601
RETAINER
RADIATOR SPEAKER GRILLE
 Plastic
 G.M. '85/
UNIT PACKAGE 25



99-8573

Replaces: 15288146, 15893516
RETAINER-WINDSHIELD PILLAR
MOULDING
 Plastic w/Seal
 Hole: M9
 Chevrolet Equinox 2005/
UNIT PACKAGE 15

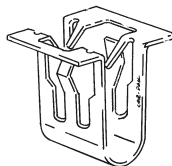

99-8215

Replaces: 16662182, 25580123
RETAINER-INTERIOR LIFTGATE TRIM &
DOOR SCUFF PLATE
 15/32" X 9/16" X 19/32"
 Zinc Finish
 G.M. 'U', 'F' & 'J' Bodies '93/
UNIT PACKAGE 25

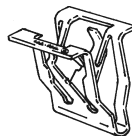

99-8632

Replaces: 11588650
CLIP- W/S GARNISH, INTERIOR TRIM
PANELS, BEZELS & SCUFF PLATES
 G.M. Cars, Lt Duty Trucks &
 Hummer 2002/
UNIT PACKAGE 10

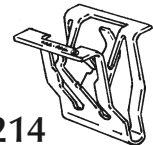

99-8214

Replaces: 15748479,
 W704021-S100, W710769-S424
RETAINER-INTERIOR DOOR OPENING
TRIM & SCUFF PLATE, W/S GARNISH
 1/2" X 1/2" X 5/8"
 Zinc Finish
 Buick Rendezvous, Chevrolet Trail Blazer,
 Hummer H2 2002/
 G.M. 'H', 'U' & 'W' Bodies '92/
 Ford Mustang, 500, Monterey 2005/
UNIT PACKAGE 25

GRILLE / COWL & SPLASH SHIELD

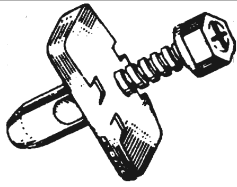
**79-4979**

Replaces: 14013241
RIVET-SCREW TYPE, GRILLE MOUNTING
 Hole: 1/4", Flange: 9/16" x 1"
 Black Plastic
 Chevrolet "X" Car '80/
UNIT PACKAGE 25

**89-6681**

Replaces: 22538004
RIVET-SCREW TYPE (Torx Drive)
 Radiator Grille to Headlamp Housing
 Hole: M6.3, P.R.: 2.5 - 5MM
 Flange: 17MM
 G.M., Pontiac, Olds "J" Body '89/
UNIT PACKAGE 50

**87-6301**

Replaces: 10053182
RIVET-SCREW TYPE
 Body Splash Shield - Plastic
 Hole: M8, P.R.: 2-10MM
 Flange: 15MM
 G.M. "W" Body '88/, "J" '95/,
 Cobalt 2005/
UNIT PACKAGE 25

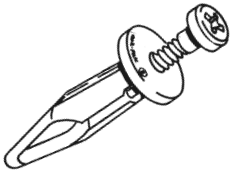
**99-7934**

Replaces: 10246149
RIVET-SCREW TYPE
 ROCKER PANEL MOULDING, GRILLE
 Hole: M6, Flange: 11MM, PR: 4.5-7.5MM
 G.M. "N" Body '99/ & S/T Truck '95/
UNIT PACKAGE 25

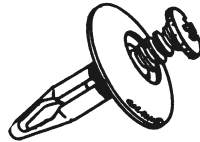
**99-8199**

Replaces: 25663903
RIVET-SCREW TYPE
 Upper Radiator Shield
 Plastic
 Hole: M6.3, Stem Lgth.: 25MM,
 Flange: 25.4MM, P.R.: 9-11MM
 Cadillac Seville '98/
UNIT PACKAGE 15

**94-7215**

Replaces: 91503-SP0-003, 94530623
RIVET- SCREW TYPE,
 BUMPERS & GRILLE
 Hole: M10, Flange: 20MM
 P.R.: 4-8MM
 Plastic
 Honda '92/, Accura '91/,
 Chevrolet Aveo 2004/
UNIT PACKAGE 10

**99-8118**

Replaces: 25695687
RIVET - DRIVE TYPE (REUSEABLE),
 RADIATOR SUPPORT SIGHT SHIELD
 Plastic
 Hole: M9, Flange: 27MM,
 P.R.: 9.8 - 11.8MM
 Cadillac Deville, DTS, Seville, STS 2000/
 Buick Lucerne 2006/
UNIT PACKAGE 15

**82-5496**

Replaces: 10017619
RIVET-DRIVE TYPE, RADIATOR
 LOWER GRILLE
 Hole: 14", P.R.: 1/8" - 1/4"
 Flange: 7/16"
 White Plastic
 Pontiac '80/
UNIT PACKAGE 25

**79-5026**

Replaces: 14003786
RIVET-DRIVE TYPE, REAR BUMPER FACE
 Bar End Cap Retainer
 Hole: 3/16", P.R.: 3/16" - 1/4"
 Flange: 7/16"
 Black Plastic
 G.M. Bodies '80/
UNIT PACKAGE 50

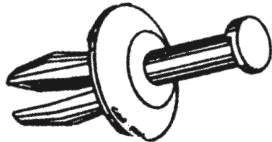
**82-5486 (J05502)**

Replaces: 14019206, 34201621,
 6508746AA
RIVET-DRIVE TYPE, FENDER APRON
 BUMPER COVER, Plastic, Black
 Hole: 1/4", P.R.: 1/16" - 7/32"
 Washer Face: 11/16"
 G.M. '83/, Ford, Chrysler LH & Pacifica
 Dodge Journey 2009
UNIT PACKAGE 50

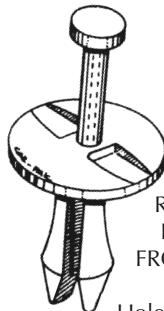
**83-5634**

Replaces: 14045480
RIVET-DRIVE TYPE
 FRONT & REAR FASCIA
 ATTACHMENT
 Hole: 5/16", P.R. 1/8" - 1/4"
 Washer Face: 1"
 Black Plastic
 Chevrolet 'A' Car '82
UNIT PACKAGE 25

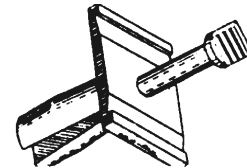
**96-7589**

Replaces: 14032200
RIVET-DRIVE TYPE
 Hole: 5/16", Stem Length: 19/32"
 Flange: 19/32 x 3/4"
 (Formerly 82-5485)
 Black Plastic
 G.M.
UNIT PACKAGE 50

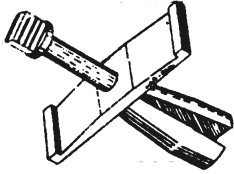
**82-5483**

Replaces: 14015161 Chevrolet
175-853-695 V.W.
RIVET-DRIVE TYPE
GRILLE ATTACHING
Hole: 5/16", Flange: 5/16" x 1-1/16"
Black Plastic
G.M. & Volkswagen
UNIT PACKAGE 50

**83-5663**

Replaces: E3DZ-14A163A
14019205, 14019206
8934-201-621
RIVET-DRIVE TYPE, GENERAL PURPOSE
Hole: 1/4", P.R.: 1/8" - 1/4"
Flange: 11/16"
Black Plastic
Ford, G.M., American Motors
UNIT PACKAGE 25

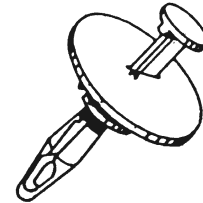
**87-6302**

Replaces: 1636632, 20687704
RIVET-DRIVE TYPE
Fascia Attachment
Hole: M6, P.R.: 2-10MM
Flange: 17MM w/10MM Shoulder
G.M., Buick & Olds '86/
UNIT PACKAGE 25

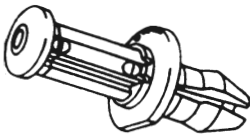
**93-7193**

Replaces: 25612415
RIVET-DRIVE TYPE
Radiator Grille Filler Panel
Plastic
Hole: M10, Flange: 20MM
G.M. Olds '88 - '92/
UNIT PACKAGE 15

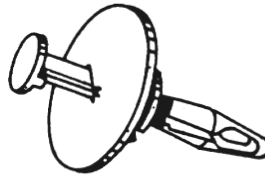
**87-6300**

Replaces: 14101262
RIVET-DRIVE TYPE
Engine Compartment - Plastic
Hole: M6.3, P.R. 2-12MM
Flange: 25MM w/12MM Shoulder
G.M. "W" Body '88/
UNIT PACKAGE 25

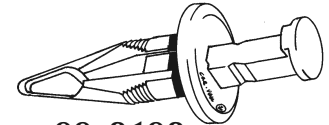
**99-8198**

Replaces: 11517803, 11519444,
4857753AA, W709984-S300
RIVET-DRIVE TYPE, Plastic
Cowl, Bumper Cover & Grille, Front Lamps
Hole: M10, Flange: 18MM,
Stem Lgth.: 26MM, P.R.: 6.2-8.7MM
G.M. 'W' & 'U' Bodies '97/
'B' Bodies 2001/ Lt. Duty Trucks, Cadillac
XLR, Pontiac G6 2005/, SAAB 9-7X 2005/
Saturn 2000/, Ford Flex 2009
UNIT PACKAGE 25

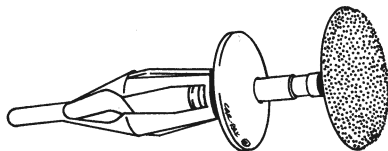
**99-7927**

Replaces: 3540858
RIVET-DRIVE TYPE, RADIATOR AIR
BAFFLE, INSTRUMENT PANEL
Plastic
Hole: M6.3, Flange: 19MM, PR: 5.6-8.5MM
Cadillac "E" & "K" Body &
G.M. "U" Van '93/
UNIT PACKAGE 25

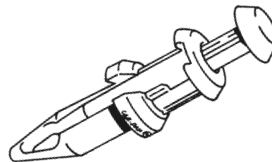
**99-8002**

Replaces: 25099299
RIVET-DRIVE TYPE
Rad Sight Shield
Plastic - Hole: M6.5, Flg.: 12.5
PR.: 3.5MM
G.M. Cars & Trucks '94/
UNIT PACKAGE 15

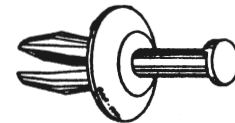
**86-6085**

Replaces: 14071289
RIVET-DRIVE TYPE
VARIOUS APPLICATIONS
Hole: M8, Washer: 17MM,
P.R.: 2.0 - 6.0MM
Black Plastic
G.M.
UNIT PACKAGE 50

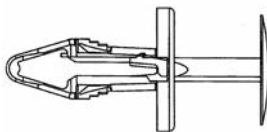
**99-8695**

Replaces: 11589291, W713331-S300
RIVET-DRIVE TYPE,
AIR DAM & GRILLE
Plastic
Hole: M6.25-6.53, Flange: 18MM,
Stem Lgth: 22MM, P.R.: 7-9.5MM
G.M. 2006/ & Ford
UNIT PACKAGE 25

**69-3326**

Replaces: 2998430
RETAINER-UPPER GRILLE ATTACHMENT
For Plastic Grille
Cadillac '76/, Valiant, Dart, Belvedere,
Coronet '70
UNIT PACKAGE 25
J03875
UNIT PACKAGE 50

**77-4692**

Replaces: 387258-S, 20032850, 3861577
RETAINER-STONE SHIELD
Ford, Chrysler & G.M. Products '76/
UNIT PACKAGE 100



72-3704

Replaces: 332364, 20732399, 2565537, 4004569, 389358-S, W701259-S300, 3691590, 6031321, 6505411, 6505425

RETAINER-FENDER, BUMPER, HOOD SEAL & INTERIOR TRIM

Hole: 1/4", Head: 11/16", Stem Lgth: 5/8" G.M., Hummer, AMC, Ford & Chrysler

UNIT PACKAGE 100

J04444

UNIT PACKAGE 50

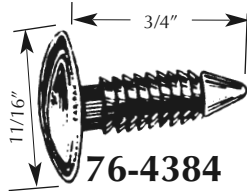

76-4384

Replaces: 1605396, 15958694, 6030441, 6502078, 388577-S, 6036007AA

RETAINER-PLASTIC SHIELD, FENDERS AND ENGINE COMPARTMENT

G.M. Cars '76/, Chrysler Products '76/, Ford Products '76/, Jeep Liberty 2002

UNIT PACKAGE 100

J05546

UNIT PACKAGE 50

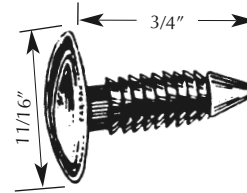

J06555

RETAINER-TRIM PANEL

Gray Plastic
G.M. & Universal
UNIT PACKAGE 50

1/4" HOLE

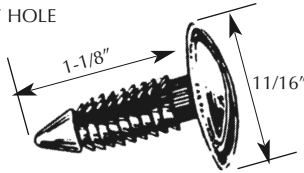

95-7387

Replaces: 6033082, 10121502, 390018-S, W708888-SAB, W709346-S300

RETAINER-COWL GRILLE,

FRT. BUMPER FENDER

Plastic

G.M., Ford, Chrysler

UNIT PACKAGE 50

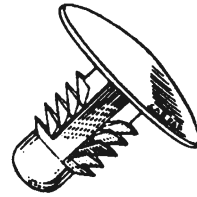

80-5158

Replaces: 1619321
RETAINER-VINYL SPLASH SHIELD RADIATOR TO BAR, COWL VENTS

Hole: 3/8", Head: 1"

G.M. '80/

UNIT PACKAGE 50



99-8073

Replaces: 14101698
RETAINER-UPPER RADIATOR BAFFLE
Plastic

Hole: M 6.3, P.R.: 2-7MM, Head: 18MM
Chevrolet Corsica '87/
UNIT PACKAGE 25



93-7105

Replaces: 15672328
RETAINER-RADIATOR GRILLE

Hole: 5/16", Flange: 3/4"

O/L - 1-7/16"

Plastic

G.M., Oldsmobile Bravada '91/

S10 Blazer '91/

UNIT PACKAGE 25

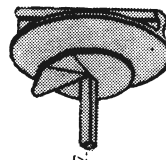

UNASSEMBLED



87-6346

Replaces: 10053163
RETAINER-UPPER RADIATOR SHIELD

"Twist Lock" Type Rivet

Plastic

G.M., Buick "W" Regal '88/

UNIT PACKAGE 15

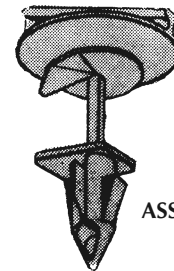

ASSEMBLED

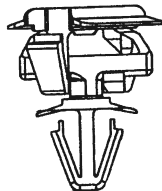

99-8028

Replaces: 15025531, 15764320

RETAINER-FRONT GRILLE

Plastic-2 Piece

Hole: 8.5 x 13MM, Head: Phillips, PR: 3MM

G.M. C/K Truck '99/

UNIT PACKAGE 10



93-7133

Replaces: 90058568
RETAINER-INSULATION PANEL

Hole: M8, P.R.: 7.0 - 15.0

Head: 20MM

Plastic

Formerly 89-6614

G.M. Import Vehicles

& General Purpose

UNIT PACKAGE 25



82-5588

Replaces: 1690410
RETAINER-FRONT FENDER FLAP

Hole: 3/16", Head: 5/8"

Black Plastic

Cadillac '80/

UNIT PACKAGE 50

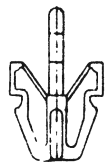
**88-6499**Replaces: 90467-12020, H200-S0-715
BF67-S0715**CLIP-GRILLE & HEADLAMP DOOR**

Gray Plastic

Toyota Corolla '83/, Chevrolet Nova '86/
Mazda 323 '86/. Ford Festiva & Tracer '88/
UNIT PACKAGE 25**94-7221****CLIP-RADIATOR GRILLE**

Plastic

G.M. Olds "N" & "H" Bodies '86/
Pontiac "H" Body '88-'91
UNIT PACKAGE 15**99-8791**

Replaces: 15002520

CLIP-RADIATOR GRILLE
FORMERLY 94-7311G.M. S-10, Full Size SUV Trucks
& 'G' Vans '94-2007
UNIT PACKAGE 15**99-8609**

Replaces: 15078238, 15033681

CLIP-COWL VENT, RADIATOR GRILLE
& BUMPER COVER

Slot: 8x25.4MM, Flange: 16.5x25MM

G.M. C/K Pick-Up/SUV,
Trailblazer/Envoy & 'G' Vans '99/
G.M. Hummer H2 2002/
UNIT PACKAGE 15**99-8777**

Replaces: 11588333

CLIP-RADIATOR GRILLE

Green

Slot: 8x16MM, Flange: 16.5x23MM
G.M. C/K Truck 2003-2007
UNIT PACKAGE 5**99-8778**

Replaces: 11562364, 4806226AA

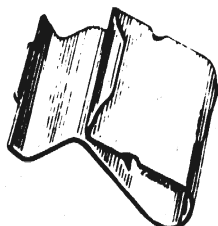
CLIP-RADIATOR GRILLE
& REAR BUMPERBuick Lucerne, Cadillac CTS 2006/
Chrysler 300, Dodge Nitro,
Jeep Commander 2005/
UNIT PACKAGE 15**73-3832**

Not Available from O.E.

CLIP-WIRING ON ROCKER PANELSVega '70 - '73 & Other G.M. Cars
UNIT PACKAGE 50**70-3397**

Replaces: 8720601

CLIP-COWL AIR OUTLET HINGE RODChevelle, Buick Special, Tempest,
Cutlass '70 - '71*UNIT PACKAGE 100***90-6829**

Replaces: 15686142, N802865

NUT-GRILLE, BUMPER
& RADIATOR SUPPORT

Screw M4.2

Black Finish

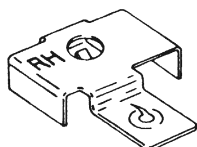
G.M. & Lincoln '83/
UNIT PACKAGE 25**93-7128**

Replaces: 10155560

BRACKET-RADIATOR GRILLE

RIGHT SIDE

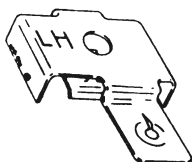
G.M. Lumina ("W" Body) '91/
UNIT PACKAGE 5**93-7129**

Replaces: 10155559

BRACKET-RADIATOR GRILLE

LEFT SIDE

G.M. Lumina ("W" Body) '91/
UNIT PACKAGE 5**68-3252 (J03878)**

Replaces: 3893980

GROMMET-GRILLE ATTACHING

Nylon

Chevrolet '69/
(14 Used Per Car)*UNIT PACKAGE 100*

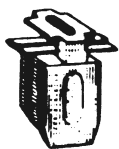

72-3573

Replaces: 3443220
RETAINER-GRILLE LOWER TO C/BAR
 Nylon
 Barracuda, Challenger '71-'72
UNIT PACKAGE 100



71-3517

Replaces: 3899596
GROMMET-LICENSE PLATE
 Nylon
 Camaro '71/ Chrysler Jeep
UNIT PACKAGE 100

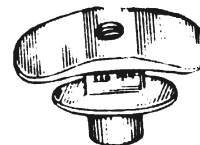

73-3829

GROMMET-GRILLE
 Plastic
 Chevrolet & GMC Pick-Up Truck '73/
 Chevrolet '76/
UNIT PACKAGE 50

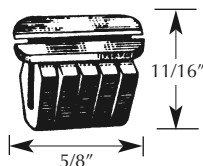

83-5752

Replaces: 25508532, 6032061
GROMMET-GRILLE ATTACHING & HOOD HINGE ASSEMBLY
 G.M. '81/, Chrysler General Usage
UNIT PACKAGE 50

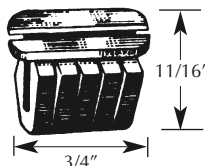

78-4819

Replaces: 1264963, 10032838
 8934-201-602, 6031869
GROMMET-MULTI PURPOSE HOOD HINGE GRILLE & FLOOR TRIM RET.
 Buick '79/, Fiero '84/, Chrysler AMC Alliance & Ford Truck
UNIT PACKAGE 50



85-5955

25525798, 8934-201-235
GROMMET-GRILLE RETAINING
 Wide Range, Plastic
 G.M. "C" Bodies '85/
 AMC Alliance, Encore '85/
UNIT PACKAGE 50

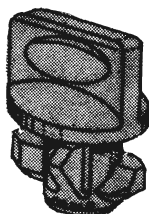

88-6407

Replaces: 14103435
RETAINER-UPPER RADIATOR SHIELD
 "Twist Lock" Plastic
 Chevrolet Corsica & Beretta '87/
UNIT PACKAGE 15

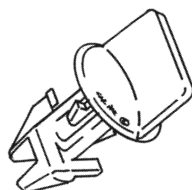

98-7872

Replaces: 25535963, N811772-S
RETAINER-SIGHT SHIELD & H/L SHROUD COVER
 Plastic - Twist Lock
 G.M. "C", "H" & "N" Bodies '94 - '96
 Ford Full Size & Lincoln T. Car '98/
UNIT PACKAGE 15



99-8025

Replaces: 15002519, 25768356,
 N800488-S301, W706675-S301,
 2L8Z-7820806-DA
NUT-THREAD CUTTING
 Grille Emblem & Moulding, Side Marker
 M5 x 10MM Hex
 w/15MM Toothed Integral Washer,
 Finish: Zinc
 G.M. Cobalt 2005/, S/T & "K" Trucks '96/
 Ford Taurus/Sable, Escape 2001/,
 Edge/MKX 2007/
UNIT PACKAGE 100

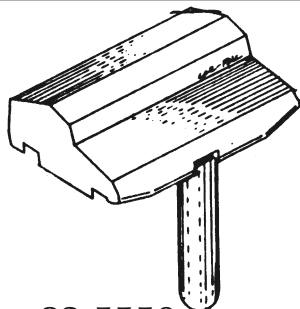

82-5550

Replaces: 14043886A
RETAINER-FRONT END PANEL
 G.M. '83/
UNIT PACKAGE 25

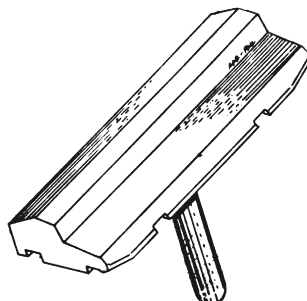

82-5551

Replaces: 14043886B
RETAINER-FRONT END PANEL
 G.M. '83/
UNIT PACKAGE 25

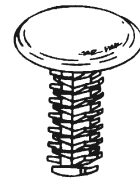
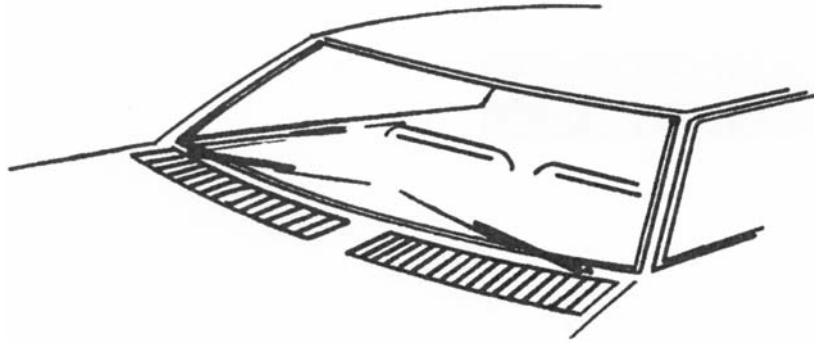

COWL VENT RETAINERS

**84-5795**

Replaces: 20511451
RETAINER-COWL VENT
 Hole: .185
 G.M. Fiero "P" Body '84/
UNIT PACKAGE 25

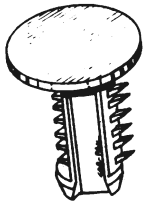
**84-5768**

Replaces: 25517947
RETAINER-FRONT FENDER SPLASH
 Shield to Body Frame Member
 G.M. "A" Body
UNIT PACKAGE 25

**85-5937**

Replaces: 20514862
RETAINER-GRILLE TO SHROUD
 Vent Grille to Windshield Shroud
 Plastic
 G.M. "N" & "L" Bodies '85/
UNIT PACKAGE 100

**99-8069**

Replaces: 10064327
 20681617
RETAINER-COWL SCREEN
 & GENERAL USAGE
 Hole: M7, P.R.: 2-5MM, Head: 15MM
 Plastic
 G.M. Fiero '87/
UNIT PACKAGE 25

**80-5158**

Replaces: 1619321
RETAINER-VINYL SPLASH SHIELD
 RADIATOR TO BAR, COWL VENTS
 Hole: 3/8", Head: 1"
 G.M. '80/
UNIT PACKAGE 50

**99-8026**

Replaces: 384051-S, 480534
RETAINER-COWL SPLASH SHIELD
 & WIRE RETAINER
 Plastic, (Formerly 69-3292)
 Hole: M6.3, Head: 10 x 25MM,
 PR: 1-9MM
 Ford & G.M. '70/
UNIT PACKAGE 50

**95-7387**

Replaces: 6033082, 10121502,
 390018-S
RETAINER*-COWL GRILLE
 Hole: 1/4", Head: 11/16", Stem: 1-1/8"
 Plastic
 G.M., Ford, Chrysler
UNIT PACKAGE 50

**90-6798**

Replaces: 10119816
RETAINER-COWL SCREEN
 Hole: 7/32", O/L 1-3/8"
 Head: 19/32"
 Plastic
 G.M. "B" Bodies '91/
UNIT PACKAGE 25

**87-6326**

Replaces: 8-94133167-0
RETAINER-COWL SCREEN
 Hole: M3.5, P.R.: 5.0MM
 Head: 8.0MM
 Plastic
 G.M. Spectrum & Isuzu '85/
UNIT PACKAGE 100

**99-8557**

Replaces: 5482103
RETAINER-COWL VENT
 Plastic w/Seal
 Hole: M7, Upper Head: 13MM,
 O/L: 18MM
 Chevrolet Equinox 2005
UNIT PACKAGE 10

**86-6096**

Replaces: N-804570-S,
20664092 & 6502790
**RIVET-COWL & VARIOUS
INTERIOR TRIM APPLICATIONS**
(Screw Type)

Black Plastic, Hole: M6.3
2.5MM - 8.0MM Grip Range
Washer Face Dia.: 18.0MM
Ford, G.M., Chrysler Products
& Cadillac '98/
UNIT PACKAGE 25

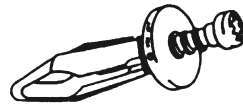
**96-7548**

Replaces: 15672149
RIVET-SCREW TYPE
COWL GRILLE
Hole: M6
Stem Length: 17.5MM
Flange: 10.10MM
Black Plastic
G.M. Blazer "S" Series '96/
UNIT PACKAGE 50

**94-7319**

Replaces: BO92-51-833, W705845-S300,
86590-28000
**RIVET-SCREW TYPE HEADLAMP
SPLASH SHIELD, COWL VENT**
Hole: M8, Flange: 18MM, P.R.: 3-7MM
Plastic
Ford Probe '89-'92, Escape '01/
Mazda '99/ & Hyundai/Kia
UNIT PACKAGE 25

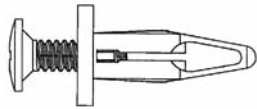
**99-8614**

Replaces: 15014352
RIVET-SCREW TYPE, COWL VENT
Plastic
Hole: M7, Flange: 14MM,
Stem Length: 23MM, P.R.: 4.5-5MM
Buick Lucerne 2006
UNIT PACKAGE 15

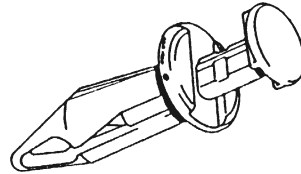
**92-7039**

Replaces: 21075686, 11561878,
F3LY-14570-B
**RIVET-DRIVE TYPE WHEELWELLS, FRONT
BUMPER UPPER FASCIA, COWL**
Hole: M8, Flange: 15MM, P.R. 3-8MM
Plastic
G.M. Saturn '91/, Corvette '97/
Grand Prix 2004 & Ford Explorer/Mtn. '95/
UNIT PACKAGE 50

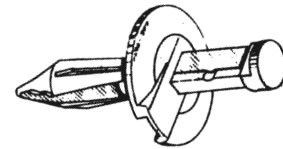
**83-5636**

Replaces: N802781-S, W704340-S300,
14093088
**RIVET-DRIVE TYPE, COWL, INTAKE
SPLASH SHIELD GRILLE & FRONT BUMPER**
Hole: M6.3, Flange: 25MM
Black Plastic
Ford '83/, G.M. Cars & Lt. Duty Trucks '84/
UNIT PACKAGE 25

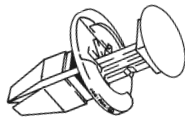
**99-8197**

Replaces: 10425306, 10301966
RIVET-DRIVE TYPE
Cowl Vent
Plastic
Hole: M7.5 Slot, Flange: 17.8MM,
Stem: 13MM, P.R.: 1-3MM
G.M. 'U' Vans 2005/, Aztek 2001/, Saturn
Relay 2005/
UNIT PACKAGE 10

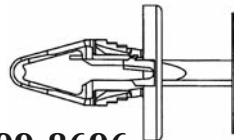
**99-8696**

Replaces: 11589289, W713610-S300,
6508863AA
**RIVET-DRIVE TYPE, Flares, Cowl,
RKR Moulding., Front Bumper, Plastic**
Hole: M6.25-6.53, Flange: 18MM,
Stem Lgth: 17.5MM, P.R.: 2-4MM
G.M. Equinox & Torrent 2007,
Buick Enclave, Saturn '91/
Ford Focus 2008/ & Dodge PU 2009/
UNIT PACKAGE 25

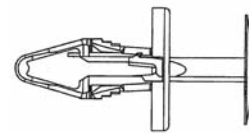
**99-8578**

Replaces: 11589290, W714040-S300
**RIVET-DRIVE TYPE,
COWL VENT & BUMPER, Plastic**
Hole: M6.25-6.53, Flange: 18MM,
Stem Lgth: 20MM, P.R.: 4.5-7.0
G.M. 'A' 'W', 'L', 'M', G5 Body 2005/
C/K Truck & SUV 2007/, Saturn Sky
2007/, Ford Flex 2009
UNIT PACKAGE 50

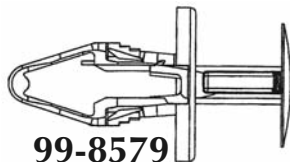
**99-8579**

Replaces: 11589293, W712196-S300
**RIVET-DRIVE TYPE,
COWL VENT, FENDER & BUMPER Plastic**
Hole: M8.25-8.53, Flange: 20MM,
Stem Lgth: 21.5MM, P.R.: 4.5-7.0
G.M. 'W', 'N' Body & Hummer 2005/
Full Size SUV & Suburban 2007/
Ford Edge/MKX 2007/, Flex 2009
Fusion/MKZ/Zephyr/Milan2006/
UNIT PACKAGE 25

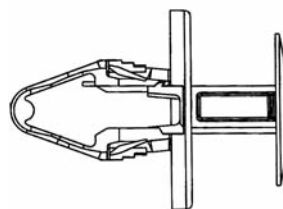
**99-8700**

Replaces: 11589295, 5GUU9K111BA,
W712665-S300
**RIVET-DRIVE TYPE,
BUMPERS, FUEL TANK SHIELD, Plastic**
Hole: M10.25-10.53, Flange: 25MM,
Stem Lgth: 20MM, P.R.: 3-6MM
G.M. HHR, G5, G6 & C/K TRUCKS 2005/
Saturn Vue 2008/, Saab 9-3 2008
Chrysler & Ford
UNIT PACKAGE 25

**99-8117**

Replaces: 11517824, 21035345
RIVET - DRIVE TYPE, COWL, MLDG.
 LAMPS, INSTRUMENT PANEL
 Plastic, Push To Release
 Hole: M7, Head: 16MM, P.R.: 4.5-6.5
 G.M. '92/, Saturn '93/ & Cadillac 'K' & 'E'
 Body '99/
UNIT PACKAGE 10

**94-7215**

Replaces: 91503-SP0-003, 94530623
RIVET- SCREW TYPE,
 BUMPERS & GRILLE
 Hole: M10, Flange: 20MM
 P.R.: 4-8MM
 Plastic
 Honda '92/, Accura '91/
 Chevrolet Aveo 2004/
UNIT PACKAGE 10

**99-8022**

Replaces: 90467-06133, 94858343
RIVET-DRIVE TYPE w/PHILLIPS RECESS
 Rocker Panel
 Textured: Plastic-Paint to match
 Hole: M6, Flange: 14MM, PR: 4MM
 Toyota '98/ & Pontiac Vibe 2003/
UNIT PACKAGE 15

**89-6574**

Replaces: B040-68-865-A96, 94530438
RIVET-SCREW TYPE
 INTERIOR TRIM, COWL, FENDER &
 BUMPER
 Hole: M6, Head Dia.: 15MM, P.R. 4-6 MM
 Plastic
 Ford Probe '88 Mazda M6 '88/
 Chevrolet Aveo 2004/
UNIT PACKAGE 25

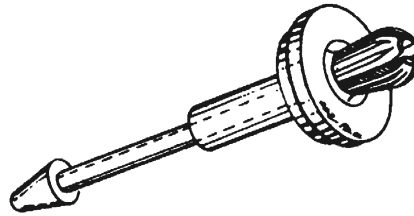
**82-5589**

Replaces: 14039971
RETAINER-COWL TOP VENT
 Hole: 1/4, Flange: 11/16, Stem Lgth: 5/32
 Black Plastic
 Chevrolet & GMC Pick-Up Truck '81/
UNIT PACKAGE 25

**87-6352**

Replaces: 10062795
RETAINER-VENT GRILLE TO
 WINDSHIELD SHROUD
 Plastic
 Fits M5 Stud, Head: 18MM,
 Stem Lgth: 13.5mm
 G.M. "W" Bodies '88/
UNIT PACKAGE 50

**96-7563**

Replaces: 10262143
RETAINER-COWL & INSULATOR
 Fits M5 Stud
 Washer Dia.: 20MM 10MM A/F
 Black Plastic
 G.M. "W" Bodies '96/, Honda & Acura
UNIT PACKAGE 25

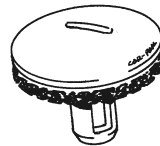
**97-7748**

Replaces: 10281610
RETAINER- COWL VENT
 Plastic w/Foam Washer
 Fits M5 Stud, Head Dia: 30MM,
 Stem Lgth: 15MM
 Olds Intrigue '98/
UNIT PACKAGE 15

**88-6410**

Replaces: 15596280
GROMMET- COWL, FRONT RADIATOR
 GRILLE
 Plastic
 G.M. Mini Van '85/, Pick-up '88/
UNIT PACKAGE 25

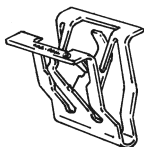
**99-8214**

Replaces: 15748479W704021-S100, W710769-S424
RETAINER-INTERIOR DOOR OPENING TRIM &
 SCUFF PLATE, W/S GARNISH
 1/2" X 1/2" X 5/8"
 Zinc Finish
 Buick Rendevous, Chevrolet Trail Blazer,
 Hummer H2 2002/
 G.M. 'H', 'U' & 'W' Bodies '92/
 Ford Mustang, 500, Monterey 200/
UNIT PACKAGE 25

**99-8609**

Replaces: 15078238, 15033681
CLIP-COWL VENT, RADIATOR GRILLE
 & BUMPER COVER
 Slot: 8x25.4MM, Flange: 16.5x25MM
 G.M. C/K Pick-Up/SUV,
 Trailblazer/Envoy & 'G' Vans '99/
 G.M. Hummer H2 2002/
UNIT PACKAGE 15

BUMPER / LIGHT / TRUNK

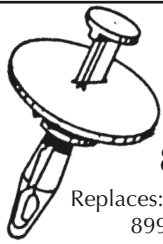
**88-6447**

Replaces: 14103438, 10077283
89955022134 AMC
RIVET-DRIVE TYPE,
FRT. BPR. FASCIA
Plastic
Hole: M9.5, P.R.: 7-14MM
Shoulder: 12.5 x 6MM, Flange: 25MM
UNIT PACKAGE 25

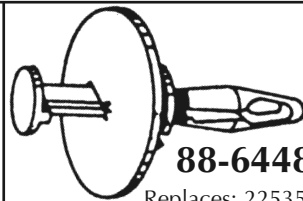
**88-6448**

Replaces: 22535007
RIVET-DRIVE TYPE, FASCIA
ATTACHMENT
Hole: M9.5, P.R.: 7-10MM
Flange: 25MM, Shoulder: 12.5 x 3MM
G.M. Olds Cutlass Ciera '87/
Pontiac '90/ "U" Van
UNIT PACKAGE 25

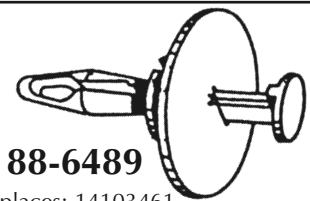
**88-6489**

Replaces: 14103461
RIVET-DRIVE TYPE, BUMPER,
FENDER APRON
Hole: M9.5, P.R.: 4-12, Head: 22MM
Shoulder: 12.5 x 4MM
G.M. Various Models, Saturn 2007,
SAAB 9-7X 2005/
UNIT PACKAGE 25

**81-5433**

Replaces: 5973400
RIVET-DRIVE TYPE
Front & Rear Bumper
Energy Absorbing
Strip & Rad.
Fan Shroud
Shoulder: 1/8"
Black Plastic
G.M. '81 Monte Carlo
& All '82/ APV Van
(10 Used Per Car)
UNIT PACKAGE 25

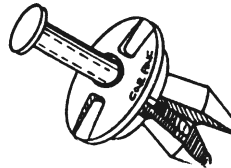
J05808*UNIT PACKAGE 50***81-5434**

Replaces: 5973823
RIVET-DRIVE TYPE
Front & Rear Bumper
Energy Absorbing Strip
Shoulder: 3/16"
Blue Plastic
G.M. '81 Monte Carlo & All '82/
(10 Used Per Car)
UNIT PACKAGE 25

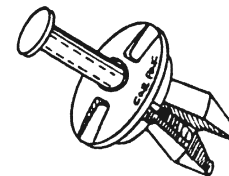
**81-5435**

Replaces: 5973996
RIVET-DRIVE TYPE
Front & Rear bumper
Brown Plastic
Energy Absorbing Strip
Shoulder: 1/4"
G.M. '81 Monte Carlo & All '82/
(10 Used Per Car)
UNIT PACKAGE 25

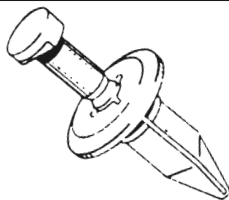
**92-7086**

Replaces: 10108746
RIVET-DRIVE TYPE
FRONT & REAR BUMPER FASCIA
Hole: M8 w/10 x 4MM Shoulder
Flange: 20MM
Plastic
G.M. "B" Bodies '91/
UNIT PACKAGE 25

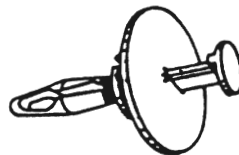
**96-7578**

Replaces: 22587036
RIVET- PIN TYPE
BUMPER COVER
Hole: M6.3, Stem Length: 24MM
Head: 25MM, Shoulder: 4 x 10MM
Black Plastic
G.M. "J" Bodies '95/
UNIT PACKAGE 25

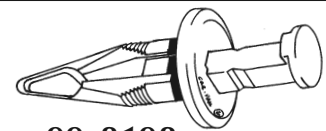
**99-8198**

Replaces: 11517803, 11519444,
4857753AA, W709984-S300
RIVET-DRIVE TYPE. Plastic
Cowl, Bumper Cover & Grille, Front Lamps
Hole: M10, Flange: 18MM,
Stem Lgth.: 26MM, P.R.: 6.2-8.7MM
G.M. 'W' & 'U' Bodies '97/
'B' Bodies 2001/ Lt. Duty Trucks, Cadillac
XLR, Pontiac G6 2005/, SAAB 9-7X 2005/
Saturn 2000/, Ford Flex 2009
UNIT PACKAGE 25

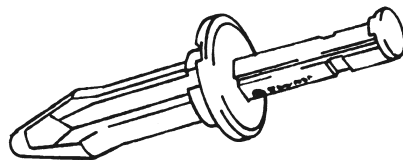
**94-7303**

Replaces: 15959832
RIVET-DRIVE TYPE
Hole: M10, Flange: 25MM
Shoulder: 12 x 2.0MM,
Stem Length: 41MM
Black Plastic
G.M. S-10 Trucks Front License Plate
Bracket '94/
UNIT PACKAGE 10

94-7304

Replaces: 15959833
RIVET - DRIVE TYPE
Hole: M10, Flange: 25MM
Shoulder: 12 x 2.0MM, Stem Length: 45MM
Gray Plastic
G.M. S-10 Trucks Front License Plate
Bracket '94/
UNIT PACKAGE 10

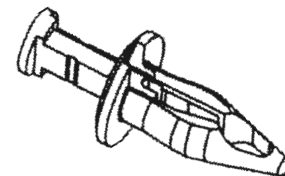
**99-8448**

Replaces: 11588988
RIVET-DRIVE TYPE
Front Bumper Cover
Plastic
Hole: M9-10, Flange: 18MM,
Stem Lgth: 26MM, P.R.: 6-7MM
Pontiac Grand Prix 2004
UNIT PACKAGE 25

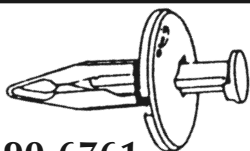

90-6761

Replaces: 10157900, 15993201
RIVET-DRIVE TYPE
 Front & Rear Fascia, Rocker Panel & Fender Apron
 Hole: 9.5MM, Washer Head: 18MM
 P.R.: 4-7MM
 Plastic
 G.M. Olds "W" Body '90/, Lt. Duty Trucks '94/
UNIT PACKAGE 25

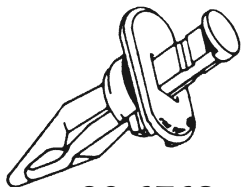

90-6762

Replaces: 10082553
RIVET-DRIVE TYPE
 Rear Bumper Fascia
 Hole: 9.5MM, Flange: 14 x 21.5MM Oval
 Shoulder: 12.5MM, P.R.: 4-10MM
 Plastic
 G.M. Olds "H" Body '90/
UNIT PACKAGE 25

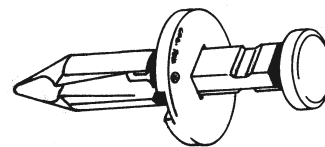

99-8363

Replaces: 15994165
RIVET - DRIVE TYPE
 BUMPER & REAR WHEEL APRON
 Plastic
 Hole: M8, Flange: 16.5MM, Stem Lgth: 27MM, P.R.: 11-12MM
 Saturn 'L' Series 2000/
UNIT PACKAGE 25



91-6924

Replaces: 10159259
RIVET-DRIVE TYPE
 Front Bumper Fascia
 Hole: 9.5MM, Flange: 25MM
 Shoulder: 12. x 5MM, P.R.: 6-9MM
 Plastic
 Chevrolet Olds "U" Van '90/
UNIT PACKAGE 25

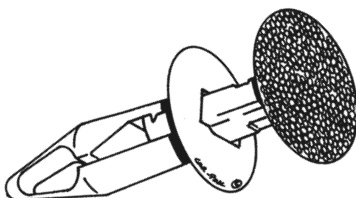

98-7874

Replaces: 15153415
RIVET-DRIVE TYPE REAR BUMPER COVER
 Plastic; Hole: M8.5, Flange: 17MM, Head: 20MM P.R.: 5MM
 G.M. "C/K" Trucks '99
UNIT PACKAGE 25

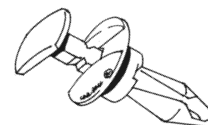

97-7688

Replaces: 20687704
RIVET- DRIVE TYPE REAR FASCIA
 Plastic
 Hole Dia: M6, Shoulder: 10 x 3.6MM
 Washer Face: 17MM
 Maximum Panel Thickness: 3.4MM
 G.M., Malibu '97/
UNIT PACKAGE 10

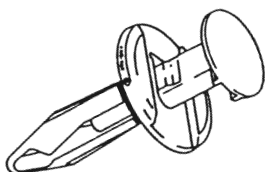

99-8377

Replaces: 11518017
RIVET - DRIVE TYPE
 COWL, BUMPER, FENDER APRON
 Plastic
 Hole: M8, Flange: 20MM, Stem Lgth: 26MM, P.R.: 3-5MM
 G.M. Various Models 2003/
UNIT PACKAGE 15

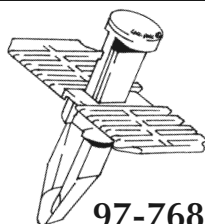

97-7687

Replaces: 22659122
RIVET- DRIVE TYPE FRONT FASCIA
 Plastic
 Hole Dia: M9 Sq., Flange: 29 x 45MM
 Shoulder: M13 x 3.3MM
 Panel Thickness: .71-.79MM
 G.M., Malibu '97/
UNIT PACKAGE 10

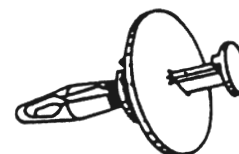

99-7922

Replaces: 22542705
RIVET-DRIVE TYPE,
 FRONT BUMPER FASCIA
 Hole: M10, Flg: 25MM
 P.R.: 3.5-7MM w/shoulder
 G.M. Camaro & Grand Am '98/
UNIT PACKAGE 25



98-7898

Replaces: 25618359
RIVET-DRIVE TYPE
 FRONT BUMPER COVER
 Hole:M7, Flange:12X22MM, P.R.: 3.7MM
 Plastic
 Buick Park Ave '92/
UNIT PACKAGE 25

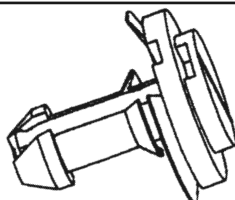

99-8030

Replaces: 15733971
RIVET-DRIVE TYPE
 FRT. AIR DAM TO BUMPER
 Plastic - Use w/99-8029
 Hole: M12, Flg: 26.5MM, PR: 2MM
 G.M. C/K, S/T, Pick Ups/SUV,
 'G' Van's '99/, SAAB 9-7X 2005/
UNIT PACKAGE 15

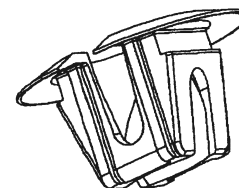

99-8029

Replaces: 15733970
Grommet-FRT. AIR DAM
 Plastic - Use w/99-8030
 Hole: 13 x 15MM, Flange: 28MM,
 PR: 2MM
 G.M. C/K Pick Up/SUV '99/,
 S/T Pick Ups 2004/ Hummer H3 2006
UNIT PACKAGE 25

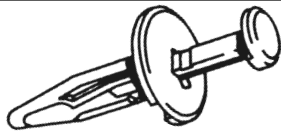
**93-7145**

Replaces: 10134407, 15990756,
F50C-9E728-AA, 6501925
**RIVET-DRIVE TYPE, BUMPER,
ROCKER MOULDING**
Hole: M6.3, Flange: 17MM
P.R.: 1.52MM - 7.62MM
Chrysler "LH" '93/, Dodge Nitro 2007/
Jeep Liberty 2002, Dodge Journey 2009
Ford & G.M., Hummer H2
UNIT PACKAGE 25

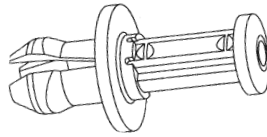
**99-8498**

Replaces: 11561349, 6507669AA
RIVET-DRIVE TYPE
Radiator Grille, Bumper
Plastic
Hole: M10, Flange: 20MM,
Stem Lgth.: 16MM, P.R.: 7.4MM
G.M. 'U' Vans 2005/ & Dodge Durango
2004
UNIT PACKAGE 25

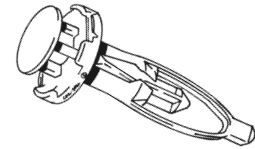
**96-7606**

Replaces: 52161-16010
RETAINER- FRONT-BUMPER
Plastic-Black
Hole Dia: M9, Flange Dia: 18MM
Stem Lgth: 28MM
Toyota Tercel '95/, Lexus '97/, Geo Prism
& Pontiac Vibe 2003/
UNIT PACKAGE 5

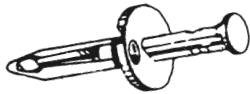
**85-5945**

Replaces: N803709-S, 15681408,
4857108
**RIVET-DRIVE TYPE, BUMPER, FASCIA &
FENDER APRON**
Plastic
Hole: M6.3, P.R.: 5 - 10MM,
Flange: 15MM
Ford '86/, G.M.,
Chrysler '97/ & Jeep 2005/
UNIT PACKAGE 50

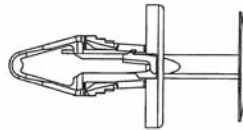
**99-8578**

Replaces: 11589290, W714040-S300
RIVET-DRIVE TYPE,
COWL VENT & BUMPER, Plastic
Hole: M6.25-6.53, Flange: 18MM,
Stem Lgth: 20MM, P.R.: 4.5-7.0
G.M. 'A' 'W', 'L', 'M', G5 Body 2005/
C/K Truck & SUV 2007/, Saturn Sky
2007/, Ford Flex 2009
UNIT PACKAGE 50

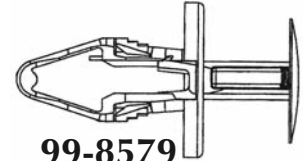
**99-8579**

Replaces: 11589293, W712196-S300
RIVET-DRIVE TYPE,
COWL VENT, FENDER & BUMPER Plastic
Hole: M8.25-8.53, Flange: 20MM,
Stem Lgth: 21.5MM, P.R.: 4.5-7.0
G.M. 'W', 'N' Body & Hummer 2005/
Full Size SUV & Suburban 2007/
Ford Edge/MKX 2007/, Flex 2009
Fusion/MKZ/Zephyr/Milan2006/
UNIT PACKAGE 25

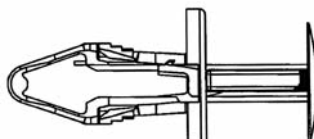
**99-8699**

Replaces: 11589294
RIVET-DRIVE TYPE,
FENDERS & BUMPERS, Plastic
Hole: M8.25-8.53, Flange: 20MM,
Stem Lgth: 24MM, P.R.: 7.0-10MM
Buick LaCrosse/Allure 2005/, Chevrolet
Traverse 2009
G.M. C/K Trucks, SUV's Hummer 2007/
UNIT PACKAGE 25

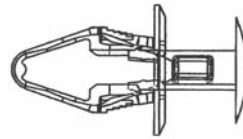
**99-8580**

Replaces: 11561368, 6508712AA
**RIVET-DRIVE TYPE, FENDER,
WHEEL & BUMPER**
Plastic
Hole: M9.25-9.53, Flange: 18MM,
Stem Lgth: 20MM, P.R.: 3.0-5.7MM
G.M. 'W' & 'M' Body 2006,
Jeep Wrangler 2006/
UNIT PACKAGE 25

**89-6652**

Replaces: 10140480, 6502625
RIVET-SCREW TYPE
Bumper Fascia Attachment
Hole: M12, Flange: 21MM
Shoulder: 3MM
Plastic
G.M. "U" & APV Van '90/
Chrysler "LH" Models '93/, Durango '98/
UNIT PACKAGE 25

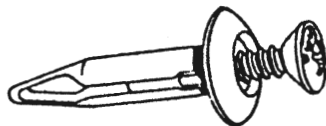
**86-6096**

Replaces: 10139822 N808147-S
RIVET- SCREW TYPE
Rear Bumper Fascia, Trunk Trim
Plastic-Black
Hole Dia: M6.3, Stem Lgth: 18MM
Head Dia: 17.5MM, P.R.: 3-8MM
G.M. "J" & "N" Bodies '91/, Ford,
Lincoln T.C. '95/
UNIT PACKAGE 25

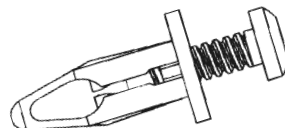
**99-8456**

Replaces: 11089262
RIVET-SREW TYPE REAR BUMPER
Plastic
Hole: M6, Flange: 11MM,
Stem Lgth: 18.5MM,
P.R.: 3-5MM, T20 Drive
Olds Alero ('N' body) '99/ &
Chevrolet Malibu ('Z' Body) 2004
UNIT PACKAGE 25

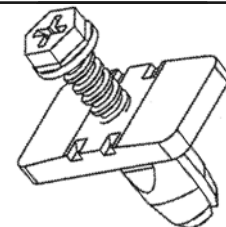
**99-8553**

Replaces: 12337831
RIVET-SCREW TYPE, FRONT BUMPER
Plastic
Hole: M8, Flange: 14x26MM,
Stem Lgth: 14MM, P.R.: 3-6MM
Pontiac G6 2005
UNIT PACKAGE 50



89-6574

Replaces: B040-68-865-A96, 94530438
RIVET-SCREW TYPE
 INTERIOR TRIM, COWL, FENDER & BUMPER
 Hole: M6, Head Dia.: 15MM, P.R. 4-6 MM
 Plastic
 Ford Probe '88 Mazda M6 '88/,
 Chevrolet Aveo 2004/
 UNIT PACKAGE 25



99-8226

Replaces: 16659130, 25672428
RETAINER - 'G' & 'H' PILLAR
 MOULDINGS, HEADER PANELS,
 REAR BUMPER PANEL
 PLUG & DOOR SILL PLATES
 Plastic w/seal
 Slot: 7x14MM, Flange: 20x36MM
 P.R.: 1.9MM
 G.M. 'C', 'G', 'H' & 'K' Bodies '93/
 UNIT PACKAGE 15



99-8350

Replaces: 24205245
RETAINER - REAR BUMPER COVER
 Plastic
 Hole: M5, Head: 9MM, P.R.: 3-10MM
 G.M. 'J' Bodies '95/
 UNIT PACKAGE 50

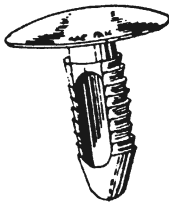

81-5428

Replaces: 22512276, 6503221
RETAINER-REAR BUMPER FASCIA
 & BUMPER AIR DAM
 G.M. '80/, "C" Body '85/,
 Chrysler Trucks '97/
 UNIT PACKAGE 50

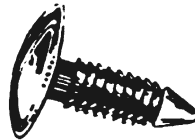

96-7502

Replaces: 10185925
RETAINER-BUMPER FASCIA
 Hole: 9/32, Head: 3/4", O/L: 1-1/4"
 Black Plastic
 G.M. "U" Bodies '93/
 UNIT PACKAGE 25



95-7393

Replaces: 21094146,
 21110201 & 6501301
RETAINER-TRIM PANELS, FRONT
 BUMPERS
 Hole: M7.9, Head: 19MM,
 Stem Length: 23MM
 Black Plastic
 G.M. Saturn '91/, C/K Trucks '99/
 Chrysler Mini Vans '87/
 UNIT PACKAGE 25



99-8288

Replaces: 22189414
RETAINER - STRUT MOUNTING,
 FRONT SPRING INSULATOR,
 FRONT BUMPER
 Plastic Textured
 Hole: M9, Head: 24MM,
 Stem Length: 19MM, P.R.: 1.6-10.0MM
 G.M. 'B', 'C', 'H', 'K' & 'U' Bodies '99/
 Jeep Grand Cherokee '99/02
 UNIT PACKAGE 25

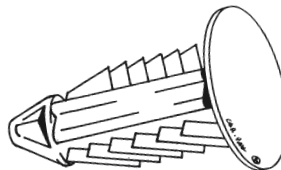

99-8167

Replaces: 11518201
RETAINER-FRONT BUMPER COVER
 Plastic
 Hole: M10-11
 Head: 21.5MM, P.R.: 0.8-15MM
 G.M. 'N' Bodies '99/
 UNIT PACKAGE 25

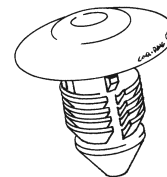

99-8224

Replaces: 15056810, 6505686AA
RETAINER - BUMPER
 Plastic
 Hole: M12.5, Head: 25MM
 O/L: 18.8MM, P.R.: 3.2-5.0MM
 G.M. S/T Trucks 2002 & Chrysler 2000/
 UNIT PACKAGE 25



99-8775

Replaces: 11589181, W711687-S300
RETAINER-BUMPER END CAP
 & FENDER APRON
 Plastic
 Hole: M6.3, Head: 18MM,
 Stem Lgth: 20MM, P.R.: 14MM Max
 G.M. Full Size Pick Ups 2007/
 Ford Focus
 UNIT PACKAGE 25

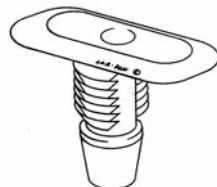

99-8742

Not Supplied by O.E.
RETAINER-FRONT BUMPER
 Plastic
 Hole: M16, Head: 20x36MM,
 O/L: 27.5MM
 Cadillac STS 2005/
 UNIT PACKAGE 15

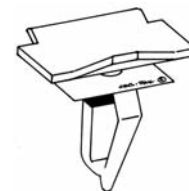

99-8773

Replaces: 11588818, 11561329
RETAINER-FRONT BUMPER
 & ROCKER MOULDING
 Plastic
 Hole: M10
 Chevrolet Corvette & Cadillac STS 2005/
 UNIT PACKAGE 10



99-8244

Replaces: 11518357, 10443956
RETAINER - FENDER, SIDE & RKR
 MOULDING, FRONT BUMPER,
 CARGO BOX
 Plastic w/seal
 Hole: M10
 Cadillac Escalade, G.M. C/K Trucks &
 'W' Bodies 2000/ & Ford Edge/MKX 2007/
UNIT PACKAGE 25

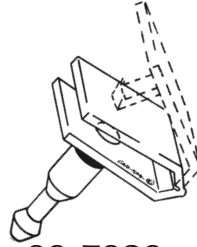

99-7929

Replaces: 22615352, 11588782
CLIP-FRONT BUMPER FASCIA
 Plastic
 Use w/99-7928
 Pontiac Grand Am '99/
UNIT PACKAGE 15



99-7928

Replaces: 22603044
GROMMET-FRONT BUMPER FASCIA
 Hole: 9.5 X 13MM
 Flange: 17.5 X 21.5MM
 Use w/99-7929
 Plastic
 Pontiac Grand Am '99/
UNIT PACKAGE 15

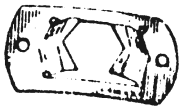

77-4709

SPEED NUT-BUMPER BOLT ATTACHING
 Screw: 3/8" - 24
 G.M. Cars & General Purpose
UNIT PACKAGE 100

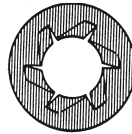

74-4067 (J02264)

Replaces: 612019
PUSH NUT-BUMPER BOLTS
 Stud Size: 7/16", O.D.: 27/32"
 Pontiac & Other Car Lines
UNIT PACKAGE 100

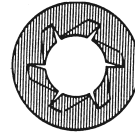

82-5498

Replaces: 10009923
PUSH NUT-BUMPER STRIPS
 Attaching
 M8 I.D., 25MM O.D.
 G.M. '78/
UNIT PACKAGE 50

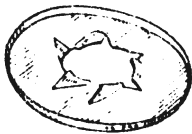

78-4831

Replaces: 11501849
PUSH NUT-BUMPER BAR BOLTS
 Bolt Size: M10
 G.M. S/T Trucks '95/ & General Purpose
UNIT PACKAGE 100

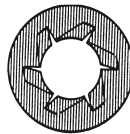

80-5249

Replaces: 11504119
PUSH NUT-BUMPER RUB STRIPS
 M14 x 25MM O.D.
 G.M. '81/
UNIT PACKAGE 100

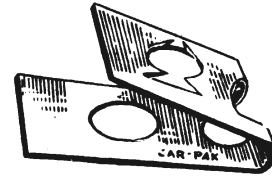

84-5803

Replaces: 10005510
U NUT-FRONT BUMPER
 (IMPACT STRIP) AND LETTERS
 Fits 3/16" Rod
 General Usage, G.M. '80/
UNIT PACKAGE 100

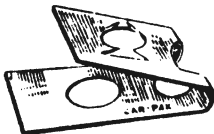

85-6008

Replaces: 10018611
U NUT-BUMPER IMPACT STRIP
 Stud Size: 1/4" (6.3MM)
 Black Finish
 G.M. "B" Bodies '82/
UNIT PACKAGE 50



72-3683 (J04555)

Replaces: 1241972
CLIP-FRONT & REAR BUMPER
 Protective Plastic Insert
 Buick '73/
UNIT PACKAGE 50



73-3836

Replaces: 1245923
CLIP-FRONT & REAR BUMPER
 Protective Plastic Inserts
 Buick '74/
UNIT PACKAGE 100

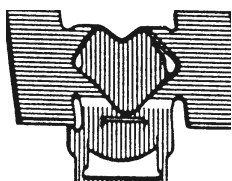

J05245

Replaces: 562327
CLIP-RUBBER BUMPER STRIP
 G.M.
 UNIT PACKAGE 50

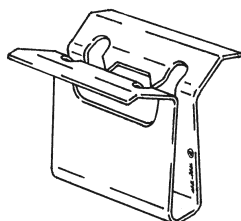

98-7845

Replaces: 3530880, 3543865
CLIP-BUMPER FILLER
 Zinc Finish
 Cadillac Seville '92/
 UNIT PACKAGE 15



99-8609

Replaces: 15078238, 15033681
CLIP-COWL VENT, RADIATOR GRILLE & BUMPER COVER
 Slot: 8x25.4MM, Flange: 16.5x25MM
 G.M. C/K Pick-Up/SUV,
 Trailblazer/Envoy & 'G' Vans '99/
 G.M. Hummer H2 2002/
 UNIT PACKAGE 15

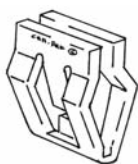

99-8689

Replaces: 11561857
RETAINER-REAR BUMPER MOULDING
 Plastic, 11x14MM
 Buick Lacrosse/Allure 2005/
 G.M. C/K Truck 2007
 UNIT PACKAGE 25



99-8661

Replaces: 14083173, 17988488,
 17997722, 25536302, N803685-S
NUT-SNAP IN STYLE
 Front Bumper, Side/High Stop Lamps,
 Rear Wheel
 Flare & Interior Trim/Dash Mountings
 Screw: M4.2 (#8), Hole: 9x11MM
 G.M., Saturn, Hummer, Ford & Jeep '82/
 UNIT PACKAGE 25



96-7503

Replaces: 10182300
RETAINER-FRONT BUMPER FASCIA
 Hole: 1/4", Head: 3/4", O/L: 1/2"
 Black Plastic
 G.M. Grand Prix '91/
 UNIT PACKAGE 50



96-7505

Replaces: 22536642
RETAINER-REAR BUMPER FASCIA
 Hole: 1/4", Head: 1/2", O/L: 3/4"
 Black Plastic
 G.M. "J" & "W" Bodies '88/
 UNIT PACKAGE 50

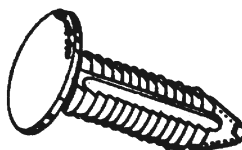

86-6059

Replaces: 1631564
RETAINER-BUMPER FASCIA
 10MM Dia. x 28MM Length
 Head Dia.: 21MM
 Black Plastic
 G.M. "C" Bodies '85/, Alero '99/
 UNIT PACKAGE 50

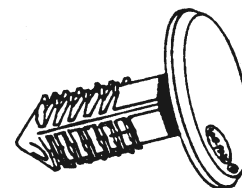

85-5957

Replaces: 15594416
RETAINER-BUMPER END CAP
 Hole: 1/4" Head: 11/16"
 Plastic
 G.M. "M" Van '85/
 UNIT PACKAGE 50



71-3499

Replaces: 6270163
RETAINER-REAR BUMPER CENTER FILLER
 Grey-Plastic
 Chevrolet '72/, Buick & Cadillac
 Chrysler Products
 UNIT PACKAGE 100
J04443
 UNIT PACKAGE 50



72-3749

Replaces: 411700
RETAINER-FLEX FILLER BETWEEN IMPACT BUMPER & FENDER
 G.M. '72/
 UNIT PACKAGE 100



74-4088

Replaces: 9662548
RETAINER-PANEL TO REAR BUMPER FILLER
 Buick & Olds '73, All "B" & "C" Bodies
 (except wagon) '74 All "B" Bodies
 UNIT PACKAGE 50

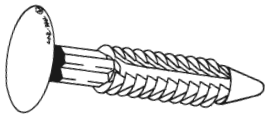
**96-7588**

Replaces: 10146315, W70595-S300

**RETAINER- FRONT BUMPER
FENDER FLARES**

Plastic-Black

Hole Dia: M6.3, O/L: 37MM

P.R.: 10.6-28.8MM, Head Dia: 17.5MM

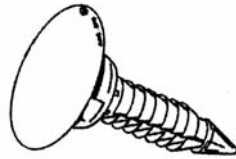
G.M. "U" Van (APV) '94/, Ford Expedition
UNIT PACKAGE 50**97-7627**

Replaces: 3548804

**RETAINER- BUMPER COVER
FRONT & REAR**

Plastic

Hole Dia: M6.3, Stem Lgth: 19MM

Head Dia: 25MM, Shoulder 4 x 12MM

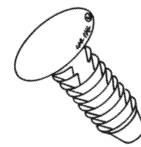
G.M. Cadillac Bodies '94/
UNIT PACKAGE 25**96-7610**

Replaces 25603960

RETAINER, RADIATOR BAFFLE

Plastic-Black

Hole Dia: M6, Stem Lgth: 11MM

Head Dia: 12.5MM

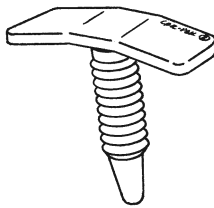
G.M. "C" Body '94/
UNIT PACKAGE 50**99-8000**

Replaces: 10299660, 10403591

RETAINER-BUMPER FASCIA

Plastic

Hole: M5, Head: 5.2 x 22MM, PR.: 11M

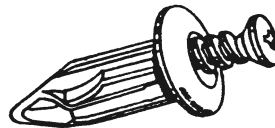
G.M. "W" Bodies '98/
UNIT PACKAGE 25**86-6060**

Replaces: 1633999

RIVET- SCREW TYPE

Plastic

Hole Dia: M10, P.R.: 9MM-15MM

Washer: 21MM

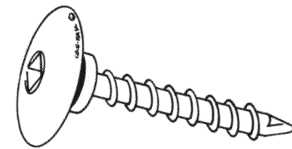
G.M. Various Panel Attachments
UNIT PACKAGE 25**97-7638**Replaces: 6503819, 25631448
SCREW- SQUARE DRIVE TRUSS HEAD

Plastic-Black

M7.5 x 34.5MM

Head Dia: 22MM, Shoulder: 4 x 9MM

Attaches Foam to Bumper Fascia

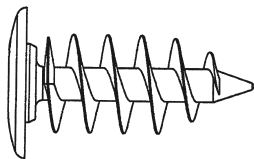
Chrysler '94/
G.M. '97/
UNIT PACKAGE 15**99-8656**

Not Supplied by O.E.

SCREW-BUMPER & DOOR INSULATORS

Plastic, Truss Head

Hole: M12, Head: 22MM, O/L: 36MM,

Thread Dia.: 14MM, Drive: #3 Square

G.M., Ford & Chrysler 2005/
UNIT PACKAGE 25**87-6310**

Replaces: 10069112

BLIND RIVET-BUMPER FASCIA

Nylon

Hole: M6.6, Flange: 21MM,

Shoulder: 10MM, Grip Range: 1-4MM

G.M. "L" Body '87/
UNIT PACKAGE 25**93-7148**Replaces: 15622490, 6032856
**BLIND RIVET-SEALING TYPE, GROUND
EFFECTS, BUMPER & GENERAL PURPOSE**

1/8" Rivet w/3/8" Flange

G.R.: .125 - .375

Black Aluminum Rivet

w/ Stainless Steel Mandrel

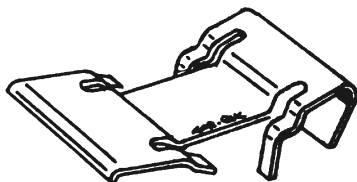
G.M. '97/Chrysler
UNIT PACKAGE 25**88-6420****CLIP-REAR BUMPER**

VALANCE PANEL

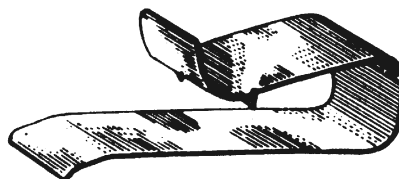
G.M. Chevrolet Baretta '87/
UNIT PACKAGE 25**72-3728**

Replaces: 333711

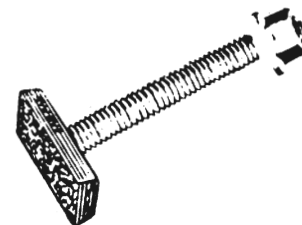
CLIP-REAR BUMPER TO BODY FILLERChevrolet '73
UNIT PACKAGE 100**78-4891**

Replaces: 561258

TEE BOLT & NUT KIT**BUMPER STRIPS & END ATTACHING**

M6-1.0x28.5MM, Head: 10.8x16.7,

3.4MM Thick

Olds '78/
UNIT PACKAGE 50 KITS

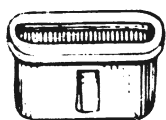
**69-3267**

Replaces: 1377030
**GROMMET-REAR BUMPER
 VALANCE PANEL**
 Pontiac '69/
UNIT PACKAGE 100
J03871
UNIT PACKAGE 50

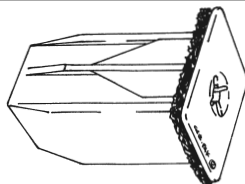
**99-8378**

Replaces: 25704358
GROMMET - REAR BUMPER
 Plastic W/Seal
 Hole: 9.5x14MM, Flange: 15x18MM,
 O/L: 23.8MM
 Screw: M6.3 (1/4-14)
 Cadillac CTS 2003
UNIT PACKAGE 15

**97-7747**

Replaces: 10271562
GROMMET-LIFTGATE SCUFF PLATE
 Plastic
 Fits: M7 X 21MM Hole
 Panel Thickness: 1.75
 G.M. Venture Van '97/
UNIT PACKAGE 25

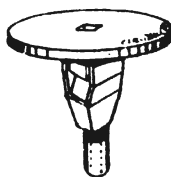
**85-6004**

Replaces: 22529957
GROMMET-FRONT BUMPER FASCIA
 Hole: M7 Sq., Screw: M4.2
 (No.8) Washer Face: 25MM
 Plastic
 Oldsmobile "A" Body '85/
UNIT PACKAGE 50

**76-4335**

Replaces: 90189-04008, 94841130
NUT-GRILLE
 G.M. Nova '85/ Toyota
UNIT PACKAGE 100

**76-4334**

Replaces: 90189-05013, 94841764
NUT-HEADLAMP BEZEL & GRILLE
 #8 Screw
 G.M. Nova '85/ Toyota
UNIT PACKAGE 100

**99-8034**

Replaces: 94842543
**NUT-PARKING & MARKER LAMP
 RETAINING & GENERAL USE**
 M4 Screw Size
 Fits 7MM Sq. Hole
 Plastic
 G.M. Nova '85/
UNIT PACKAGE 25

**77-4531**

Replaces: 1254815
**GROMMET-FENDERS,
 CORNERING LIGHTS**
 Hole: 1/4", Screw: #6
 Plastic
 Buick '77/
UNIT PACKAGE 100

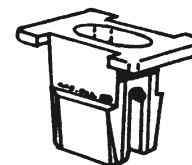
**87-6194**

GROMMET-FRONT SIDE MARKER LAMP
 Wide Range
 Screw: M4.2
 Rectangular Hole: 8.0 x 6.0MM
 Plastic
 Cadillac "C" Body (Fwd.) '86/
UNIT PACKAGE 50

**78-4827**

Replaces: 20008655
RIVET-DRIVE TYPE
 Marker Lamp Retainer
 Plastic
 G.M. "B" Body Station Wagon '79/
UNIT PACKAGE 50

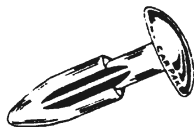
**81-5452**

RETAINER-TAIL LIGHT LENS
 Stainless Steel Capped Plastic
 Pontiac, Buick '80/
UNIT PACKAGE 25

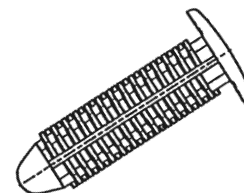
**99-8027**

Replaces: 10185866
RETAINER-HEADLAMP TRIM
 Plastic
 Hole: M7, Head: 14MM, PR: 2-21MM
 G.M., C/K Trucks '99/
UNIT PACKAGE 25

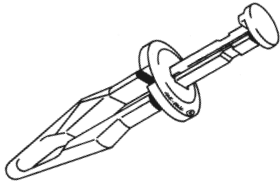
**98-7851**

Replaces: 15960621
RIVET - DRIVE TYPE
 Plastic
 Hole: M6.3, Flange: 13.5MM
 P.R.: 9MM Max.
 G.M. "G" Van, C/K Truck '95/
UNIT PACKAGE 25

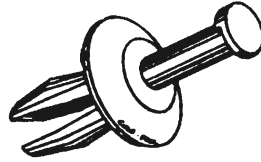
**99-8225**

Replaces: 16514113
RIVET - DRIVE TYPE
 Front Auxillary Lamp Mounting & Pivots
 Plastic
 Hole: M6.35, Flange: 17.8MM,
 Stem Length: 14.2MM, P.R.: 1.5-7.6MM
 G.M. Cars & Trucks '88/
UNIT PACKAGE 25

**99-8117**

Replaces: 11517824, 21035345
RIVET - DRIVE TYPE, COWL, MLDG.
 LAMPS, INSTRUMENT PANEL
 Plastic, Push To Release
 Hole: M7, Head: 16MM, P.R.: 4.5-6.5
 G.M. '92/, Saturn '93/ & Cadillac 'K' & 'E'
 Body '99/
UNIT PACKAGE 10

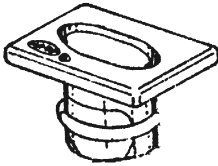
**85-5894**

Replaces: 22529009
GROMMET-SIDE MARKER
 Lamps & Headlamp Bezel Retainer
 M4.2 or No. 8 Screw
 G.M. "J" & "N" Bodies '84/
UNIT PACKAGE 50

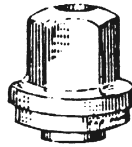
**78-4902**

Replaces: 20138524
NUT-SEALING TYPE
 Tail Light Retaining
 G.M. '79/
UNIT PACKAGE 50

**89-6673**

Replaces: 15599020
RETAINER-TAIL LAMP ASSEMBLY
 Hole: 6 x 8MM, Screw: M4.2
 Plastic
 G.M. "G" Van '87/
UNIT PACKAGE 25

**84-5885**

Replaces: 5949351
CLIP-REAR LAMP & SIDE MARKER
 RETAINING
 G.M. Camaro, Firebird '76/
 "J" & "P" Bodies '82/
UNIT PACKAGE 50

**99-8354**

Replaces: 15745991, 11609536,
 15284612, 5113360AA
GROMMET - REAR LAMP HOUSING,
 UPPER, Plastic W/ Seal
 Hole: 9 X 16MM, Flange: 13 X 20MM,
 O/L: 18.5MM, P.R.: 0.70MM
 G.M. TrailBlazer, Envoy & Bravada 2002/
 'U' Vans 2005/
 Chrysler Caravan & Dodge Journey 2008/
UNIT PACKAGE 15

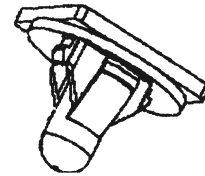
**99-8353**

Replaces: 15745990
GROMMET - REAR LAMP HOUSING,
 LOWER. Plastic W/ Seal
 Hole: M15, Flange: 24MM, O/L: 19.5MM,
 P.R.: 0.70MM
 G.M. TrailBlazer, Envoy & Bravada 2002/
UNIT PACKAGE 15

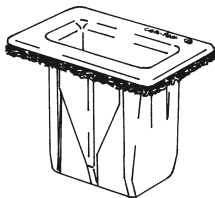
**99-8380**

Replaces: 25736754
RETAINER - REAR LAMP
 Plastic W/Seal
 Hole: 9x16MM, Flange: 14x20MM,
 O/L: 18.5MM
 Cadillac CTS 2003
UNIT PACKAGE 15

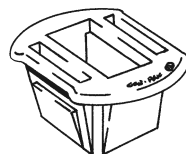
**99-8304**

Replaces: 10294517
RETAINER-HEADLAMP HOUSING PANEL
 Plastic
 Fits 10MM Slot
 G.M. APV 'U' Body Vans '97/
UNIT PACKAGE 25

**99-8779**

Replaces: F5OY-14603-A
GROMMET-HEADLAMP
 & TAIL LAMP MOUNTING, Plastic
 Hole: 9.5x13.5MM,
 Flange: 18.5x21.5MM, O/L: 19.6MM
 Ford Explorer, Navigator
 & SD Pick Up 2003/
UNIT PACKAGE 25

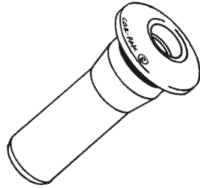

98-7897

Replaces: 15954398
**GROMMET-TAIL LAMP ASSEMBLY
 RETAINER**
 Hole: M8, Flange: 16MM, O/L: 24MM
 G.M. "U", "S" & "T" Trucks '95/
UNIT PACKAGE 25



98-7795

Replaces: 25632157
RETAINER - SIDE MARKER LAMP
 Plastic
 Fits M12 Hole
 G.M. Pontiac "H" Body '96/
UNIT PACKAGE 15

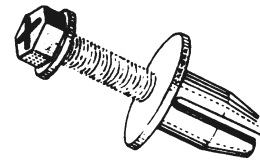

84-5794

Replaces: 20451119, 63844-01A99
**RIVET-SCREW TYPE
 FRONT COMPARTMENT SPARE TIRE
 RETAINER**
 Hole: 5/16", P.R.: .138 - .354
 G.M. Fiero "P" Body '84/, Nissan
UNIT PACKAGE 25

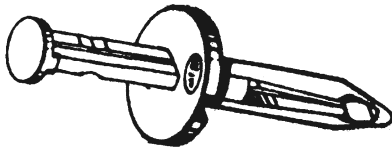

84-5840

Replaces: N803362-S, 20510029
**RIVET-DRIVE TYPE
 LUGGAGE COMPARTMENT
 RETAINER**
 Hole: M6, Flange: 18MM
 Ford Escort/Lynx '84/
 Pontiac Fiero '85/
UNIT PACKAGE 50

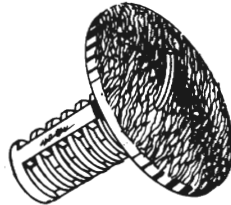

84-5798

Replaces: 20478294
**RETAINER-HOLDS CARPET OVER TAIL
 LAMPS TRUNK COMPARTMENT
 RETAINER**
 Plastic, Head: 30MM, Stem Lgth: 17MM
 Use w/ CAR-PAK 84-5799
 G.M. "C" Body '85
UNIT PACKAGE 25

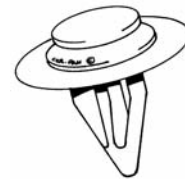

99-8690

Replaces: 22691056
RETAINER-TAILGATE MOULDING
 Plastic, W/Seal
 Hole: M 9, Head: 13MM,
 Flange: 25MM, O/L: 20MM
 G.M. Avalanche & Escalade EXT 2007
UNIT PACKAGE 15

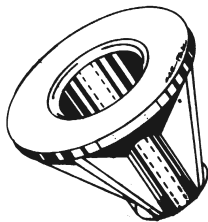

84-5799

Replaces: 20478295
**RETAINER-SUPPORT HOLDS TRUNK
 COMPARTMENT CARPET**
 Use w/ CAR-PAK 84-5798
 G.M. "C" Body '85
UNIT PACKAGE 25



99-8691

Replaces: 11561382, 11610198
GROMMET-TAIL LAMPS
 Plastic w/Seal
 Slot: 9x16MM, Flange: 13x20MM,
 O/L: 19MM
 G.M. 'Z' cars, S/T & 'U' Trucks 2002/
 Pontiac G6 2005
UNIT PACKAGE 10



99-8238

Replaces: 25649667, W705590-S300,
 W710459-S300
**GROMMET - BACKGLASS MLD, DECK
 LID, LAMPS LIFTGATE & INT. TRIM PANEL**
 Plastic w/seal
 Hole: 9x18MM, Flange: 13x22MM,
 P.R.: 0.9-1.3MM, Screw: M4.2 (#8)
 Cadillac 'E' & 'K' Bodies '98/ &
 Ford Windstar '99/
UNIT PACKAGE 15



99-8590

Replaces: 11561655, 11609862
RETAINER-REAR LAMP MOUNTING
 Plastic w/Seal
 Hole: M11, Flange: 15MM, O/L: 19MM
 Buick Terraza, Chevrolet Uplander,
 Pontiac Montana SV6, Saturn Relay 2005/
UNIT PACKAGE 5



99-8661

Replaces: 14083173, 17988488,
 17997722, 25536302, N803685-S
NUT-SNAP IN STYLE
 Front Bumper, Side/High Stop Lamps,
 Rear Wheel
 Flare & Interior Trim/Dash Mountings
 Screw: M4.2 (#8), Hole: 9x11MM
 G.M., Saturn, Hummer, Ford & Jeep '82/
UNIT PACKAGE 25



99-8807

Replaces: 11610049
**RETAINER-REAR BUMPER HITCH
 COVER**
 Plastic-1/4 Turn to Lock
 Slot: 7x12.25MM, Flange: 19MM,
 Stem Lgth: 14.5MM, O/L: 24.5MM
 G.M. Full Size SUV's & Suburbans 2007/
UNIT PACKAGE 15

BELT, REVEAL & VINYL TOP MOULDING

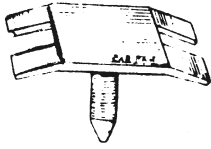

79-5067

Replaces: D9ZZ-6621060-A
RETAINER-BELT MOULDING
 Mustang '79/
UNIT PACKAGE 50

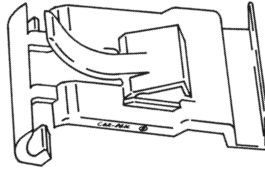

99-8023

Not Supplied By O.E.
CLIP-Belt Moulding
 Plastic
 Ford Taurus/Sable '97/
UNIT PACKAGE 25



89-6631

Replaces: N805759-S100
BLIND RIVET-WINDSHIELD SIDE RAIL
 Black Aluminum Rivet w/St. Steel Mandrel
 1/8" Dia. Domed Flange, .063 - .125 G.R.
 Ford T-Bird & Cougar '89/
UNIT PACKAGE 50



98-7833

Replaces: 384439-S61
SCREW- TAPPING, PHILLIPS ROUND
 WASHER HEAD
 Door Window & Rocker Mouldings
 #8 X 3/8" w/ 3/8" Washer Head
 Black Finish
 Lincoln Continental & Town Car '98/
UNIT PACKAGE 50

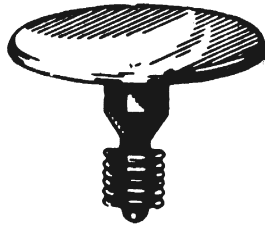

77-4697

RETAINER-TRIM PANEL
 Ford Products '76/
UNIT PACKAGE 25

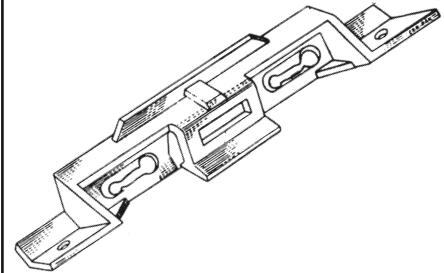

79-5085

Replaces: E0WZ-6642B42-A
CLIP-REAR WINDOW LOWER
 MOULDING
 Ford Products '80/
UNIT PACKAGE 25

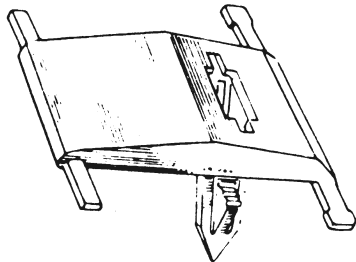

77-4588

Replaces: D74Z-5442468-A
RETAINER-REVEAL MOULDING
 Ford Products '77/
UNIT PACKAGE 25

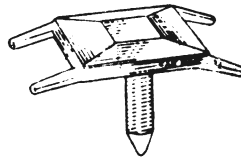

79-5091

Replaces: E0LZ-66423B06-A
RETAINER-VINYL ROOF BELT
 MOULDING
 Ford Products '80/
UNIT PACKAGE 25

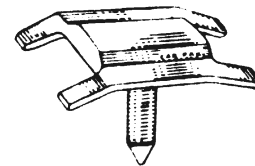

79-5096

Replaces: E0VZ-54423B06-A
RETAINER-VINYL ROOF BELT
 MOULDING
 Ford Products '80/
UNIT PACKAGE 25

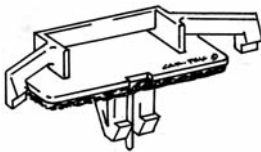

99-8786

Not Supplied by O.E.
RETAINER-ROOF MOULDING
 Plastic-White w/Seal
 Ford Five Hundred & Mercury Montego
 2005-2007
 Ford Taurus & Mercury Sable 2008/
UNIT PACKAGE 10



99-8747

Replaces: 11518988
RETAINER-SLIDING ROOF,
ROOF RACK & SPOILER
 Plastic w/Seal
 Hole: M9
 GM Bravada, Envoy, Trailblazer, SSR,
 Acadia & Hummer 2002/
 Ford Edge & MKX 2007/
UNIT PACKAGE 15

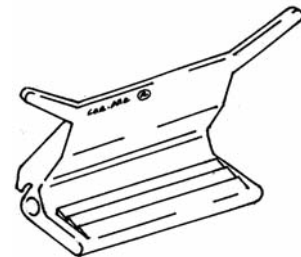

99-8523

Replaces: 4L3Z-1510182-AA
RETAINER-ROOF & GARNISH MOULDING
 Plastic
 Ford 'F' Pick-ups 2005
UNIT PACKAGE 15

FENDER & WHEEL OPENINGS

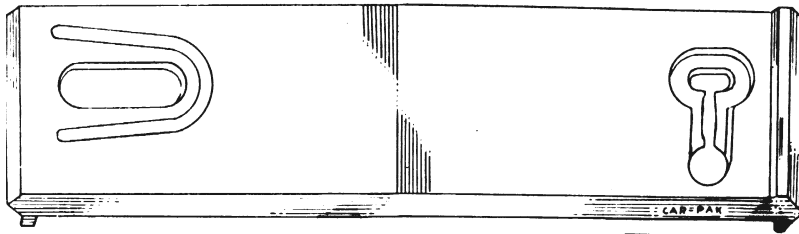
**80-5265**

Replaces: E1DZ-16C072A
CLIP-FRONT FENDER SIDE LOWER REAR MOULDING
 Ford Products '81/
UNIT PACKAGE 25

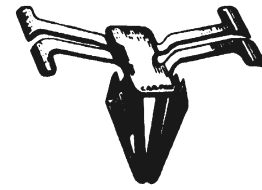
**74-4055**

Replaces: D5UZ-16794-A
RETAINER-FRONT FENDER
SIDE UPPER MOULDING
 Ford Van '75
UNIT PACKAGE 50

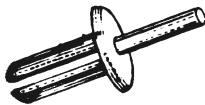
**78-4818**

Replaces: 388629-S, 15676045
RIVET-DRIVE TYPE
REAR WHEEL OPENING
 Ford Products '79/, G.M.
UNIT PACKAGE 50

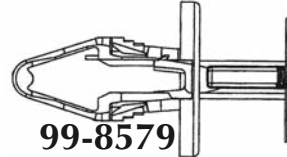
**99-8579**

Replaces: 11589293, W712196-S300
RIVET-DRIVE TYPE,
COWL VENT, FENDER & BUMPER Plastic
 Hole: M8.25-8.53, Flange: 20MM,
 Stem Lgth: 21.5MM, P.R.: 4.5-7.0
 G.M. 'W', 'N' Body & Hummer 2005/
 Full Size SUV & Suburban 2007/
 Ford Edge/MKX 2007/, Flex 2009
 Fusion/MKZ/Zephyr/Milan2006/
UNIT PACKAGE 25

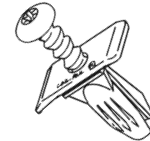
**98-7785**

Replaces: W700615-S300
RIVET-SCREW TYPE
 Plastic
Fender Splash Shield
 Hole: M6 Sq., Flange: 8 X 16MM
 Max. P.R.: 3.5MM
 Ford Contour, Mystique 95/
UNIT PACKAGE 25

**94-7319**

Replaces: BO92-51-833, W705845-S300
RIVET-SCREW TYPE HEADLAMP
SPLASH SHIELD, COWL VENT
 Hole: M8, Flange: 18MM, P.R.: 3-7MM
 Plastic
 Ford Probe '89-'92, Focus & Escape '01/
 & General Purpose
UNIT PACKAGE 25

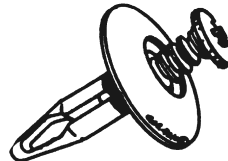
**99-8039**

Replaces: YS4Z-16K262-AA
RIVET-SCREW TYPE FENDER SPLASH
SHIELD, REAR BUMPER & RADIATOR
SHIELD
 Plastic
 Hole: M6, Flange: 16MM, P.R.: 1.6-6MM
 Stem Length: 17.5MM
 Ford Focus 2000
UNIT PACKAGE 25

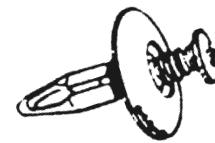
**89-6574**

Replaces: B040-68-865-A96, 94530438
RIVET-SCREW TYPE
INTERIOR TRIM, COWL, FENDER &
BUMPER, Plastic
 Hole: M6, Head Dia.: 15MM,
 P.R. 4-6 MM
 Ford Probe '88 Mazda M6 '88/
 Chevrolet Aveo 2004/
UNIT PACKAGE 25

**99-8037**

Replaces: W703507-S300
RETAINER- REAR SPLASH SHIELD
 Plastic
 Hole: M9 Sq., Flange: 18MM, P.R. 18MM
 Stud Dia.: 4.5MM
 Use w/99-8036
 Ford Focus 2000
UNIT PACKAGE 25

**99-8036**

Replaces: W703505-S301
PUSH-NUT-REAR SPLASH SHIELD
 For Plastic Studs
 Stud Size: M4.5O.D.: 22MM
 Zinc Finish
 Use w/99-8037
 Ford Focus 2000
UNIT PACKAGE 25

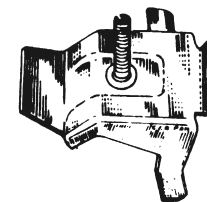
**72-3669**

RETAINER-MOULDING FASTENER
 Hood & General Purpose
 Ford, G.M. Products
UNIT PACKAGE 50

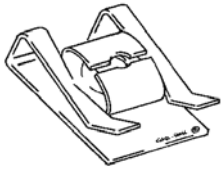

98-7772

Replaces: N802538
U-NUT- FENDER APRON
 Screw: #8 (M4.2), PR 1/16-5/32", Throat
 Depth: 5/16"
 Zinc Finish
 Ford Mustang '94/
 UNIT PACKAGE 25

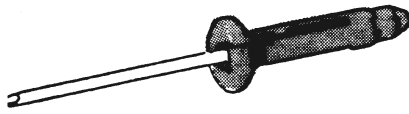

90-6760

Replaces: N-805592-S100
BLIND RIVET-LEG RETENTION STYLE
 WHEEL HOUSE MOULDING
 Leg Retension Style 3/16" Dia.
 Flange: 7/16", Grip Range: .078 - .236
 Lincoln '89/ & General Pupose
 UNIT PACKAGE 25

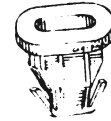

78-4817

Replaces: N800503-S
RETAINER-FRONT FENDER
 Ford Products '79/
 UNIT PACKAGE 100

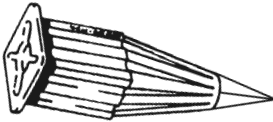

96-7565

Replaces: N804765-S
GROMMET NUT-WHEEL OPENING
 Screw: M4.2, Sq. Hole: 7.5MM
 Plastic
 Ford Various Models '95/
 UNIT PACKAGE 50



99-8055

Replaces: W703069-S300
GROMMET-FENDER SPLASH SHIELD
 Plastic
 Hole: M8 sq., Flange: 18MM, Screw: M4.2
 Ford Focus 2000
 UNIT PACKAGE 50



95-7387

Replaces: 6033082, 10121502,
 390018-S
RETAINER*-COWL GRILLE
 Hole: 1/4", Head: 11/16", Stem: 1-1/8"
 Plastic
 G.M., Ford, Chrysler
 UNIT PACKAGE 50

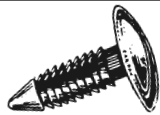

RETAINER - GENERAL PURPOSE & FORD TRUCK FENDER FLARES

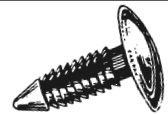

C-P #	REPL.: W706589-S COLOR	HOLE	HEAD	O/L	PANEL RANGE	UNIT PKG.
99-7977	LT. GRAPHITE	M6.3 (1/4)	17.8MM	23MM	2-13.5MM	50
99-7978	LT. PRARIE TAN	M6.3 (1/4)	17.8MM	23MM	2-13.5MM	50
99-7979	CHARCOAL	M6.3 (1/4)	17.8MM	23MM	2-13.5MM	50
99-7980	WHITE PEARL	M6.3 (1/4)	17.8MM	23MM	2-13.5MM	50
76-4384	BLACK	M6.3 (1/4)	17.8MM	23MM	2-13.5MM	100
J05546	BLACK	M6.3 (1/4)	17.8MM	23MM	2-13.5MM	50
99-8054	MATTE BLACK	M6.3 (1/4)	17.8MM	23MM	2-13.5MM	50
J06555	GREY	M6.3 (1/4)	17.8MM	23MM	2-13.5MM	50

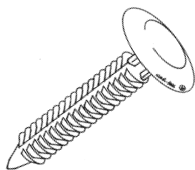

99-8216

Replaces: W701855-S300
**RETAINER-REAR BUMPERS, FENDER
 FLARES & MUD FLAPS**
 Plastic
 Hole: M6.3, Head: 22MM, O/L: 37MM
 Ford Explorer/Mountaineer 2002
 UNIT PACKAGE 25

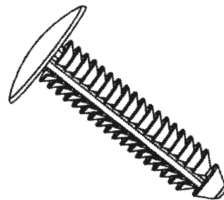

99-8413

Replaces: W709002-S
RETAINER-FENDER FLARE
 Plastic-Textured
 Hole: M6-6.35, Head: 18MM,
 Stem Lgth: 33MM, P.R.: 2-22MM
 Ford Expedition, Navigator 2003
 UNIT PACKAGE 25

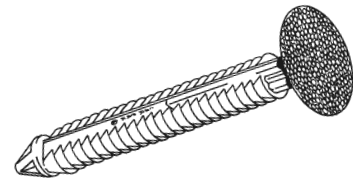

98-7881

Not Supplied By O.E.
RETAINER- MUD FLAPS
 Plastic
 Hole: M6.3, Head: 18MM
 P.R.: 10-30MM
 Ford Expedition & "F" Trucks '97/
 UNIT PACKAGE 25

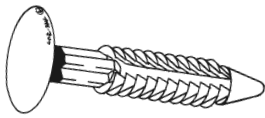
**96-7588**

Replaces: 10146315, W70595-S300
**RETAINER- FRONT BUMPER
 FENDER FLARES**
 Plastic-Black
 Hole Dia: M6.3, O/L: 37MM
 P.R.: 10.6-28.8MM, Head Dia: 17.5MM
 G.M. "U" Van (APV) '94/, Ford Expedition
UNIT PACKAGE 50

**86-6096**

Replaces: N-804570-S,
 20664092 & 6502790
**RIVET-COWL, INTERIOR TRIM,
 GRILLE, ROCKER PNL.,
 WHEEL LIP MOULDING**
 Black Plastic, Hole: M6.3
 2.5MM - 8.0MM Grip Range
 Washer Face Dia.: 18.0MM
 Ford, G.M., Chrysler Products
 Hummer H2 & Cadillac '98/
UNIT PACKAGE 25

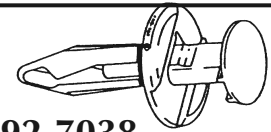
**92-7038**

Replaces: 5485676, 15691478,
 15969147, 21030249, N807389-S,
 W711035-S300, 6503598
**RIVET-DRIVE TYPE FENDER APRON,
 BUMPERS & GRILLES**
 Hole: M8, Flange: 20MM, P.R. 3-8MM
 Plastic
 G.M. Saturn '91/, G.M. C/K Truck '99/ &
 Hummer, Chrysler '95-2000, Ford 2006/
 Dodge Nitro 2007/ Jeep 2005/
UNIT PACKAGE 50

**99-8404**

Not Supplied BY O.E.
RETAINER-EXTERIOR MOULDINGS
 Plastic
 Hole: M10, Upper Hd.: 4x9.5MM,
 O/L: 16.5MM
 Ford Expedition,
 Explorer/Mountaineer 2001/
UNIT PACKAGE 15

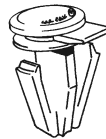
**97-7626**

Replaces: F3TZ-101012-A
**RETAINER- WHEEL LIP MOULDING
 FRONT & REAR**
 Plastic-Black
 Hole Dia: M10
 Ford Ranger & Pickups '93/
UNIT PACKAGE 25

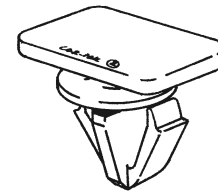
**99-7991**

Not Supplied By O.E.
RETAINER-FENDER LIP MOULDING
 Plastic
 Hole: M10, Head: 12 x 20MM
 Ford Expedition & Navigator '98/
UNIT PACKAGE 25

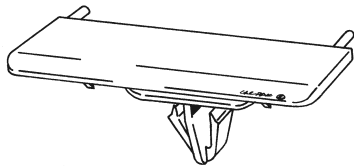
**99-7985**

Not Supplied By O.E.
RETAINER-WHEEL LIP MOULDING
 Yellow Plastic
 Hole: M10
 Ford Expedition/Navigator '98/
UNIT PACKAGE 25

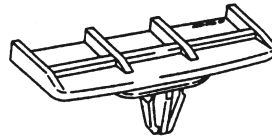
**99-8248**

Replaces: F57B-16241-AA
RETAINER-FENDER MOULDING
 Plastic-White
 Hole: M10
 Ford
UNIT PACKAGE 15

**99-8647**

Replaces: 6G1Z-5410182-C
**RETAINER-WHEEL FLARE & ROCKER
 MOULDING**
 Plastic
 Hole: M9, Flange: 14x18MM, P.R.: 0.8MM
 Ford Five Hundred 2005/
UNIT PACKAGE 25

**99-8649**

Not Supplied by O.E.
RETAINER-WHEEL FLARE
 Plastic w/Seal
 Hole: M9
 Ford Explorer 2006/
UNIT PACKAGE 15

**99-8766**

Not Supplied by O.E.
RETAINER-FENDER FLARE
 Plastic
 Hole: M9, Top Hd: 14x34MM,
 Stem Lgth: 13.5MM, P.R.: 0.8-4.0MM
 Ford Explorer 2007/
UNIT PACKAGE 25

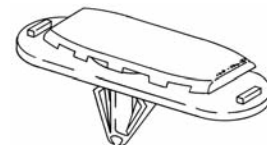
**99-8802**

Not Supplied by O.E.
RETAINER-FENDER FLARE
 Plastic
 Hole: M9, Top Hd: 15x34MM,
 Stem Lgth: 13.5MM
 Ford F250/350SD Trucks 2008/
UNIT PACKAGE 10

DOOR / QUARTER / ROCKER / DECK MOULDINGS

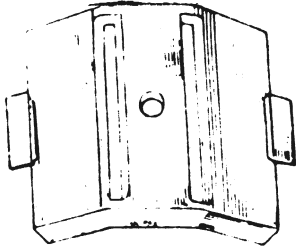

76-4265

Replaces: C8TZ-812931A
CLIP-SIDE MOULDING
 Ford Pick-up Trucks '68/
UNIT PACKAGE 100

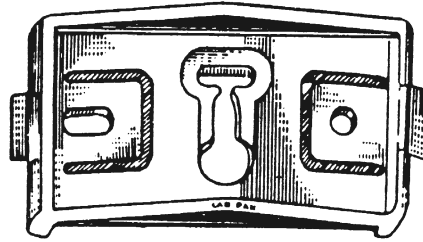

76-4376

Replaces: C9MY-5410182-A
CLIP-BODY ROCKER PANEL MOULDING
 Mercury '69/
UNIT PACKAGE 50

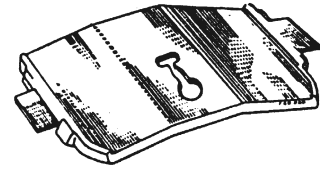

75-4201

Replaces: D3TZ-1020880-C
CLIP-VINYL BODY MOULDING
 Plastic
 Ford Pick-up Truck '71 - '76
UNIT PACKAGE 50

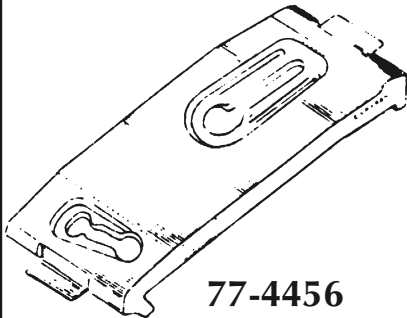

77-4456

Replaces: D1AZ-7121066A
CLIP-SIDE MOULDING
 Ford Products '71/
UNIT PACKAGE 50

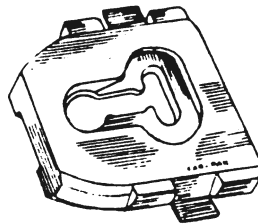

77-4473

Replaces: D1MY-6520818A
CLIP-SIDE MOULDING
 Mercury '71
UNIT PACKAGE 100

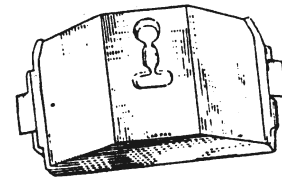

76-4248

Replaces: D3TZ-1020232A
CLIP-MOULDING
 Ford Trucks '72/
UNIT PACKAGE 50

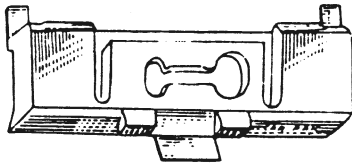

77-4634

Replaces: D3TZ-99407A52A
CLIP-TAIL GATE OUTSIDE LOWER MOULDING
 Ford Pick-up Trucks '73/
UNIT PACKAGE 50

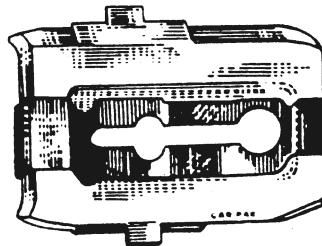

75-4176

Replaces: D40Z-6520818-A
CLIP-BODY SIDE MOULDING
 Ford Products '74 - '76
UNIT PACKAGE 100

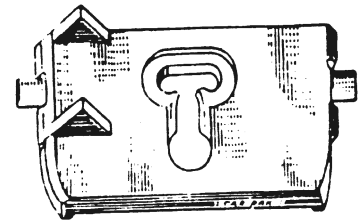

75-4191

Replaces: D4ZZ-6021066A
CLIP-BODY SIDE MOULDING
 Mustang '74 - '76
UNIT PACKAGE 100

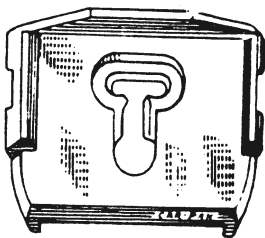

75-4189

Replaces: D5VZ-6021066A
CLIP-BODY SIDE MOULDING
 Ford Products '75 - '76
UNIT PACKAGE 50

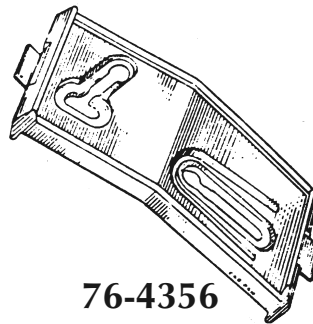

76-4356

Replaces: D7LZ-6520818A
CLIP-OUTSIDE DOOR MOULDING
 Lincoln '77/
UNIT PACKAGE 50

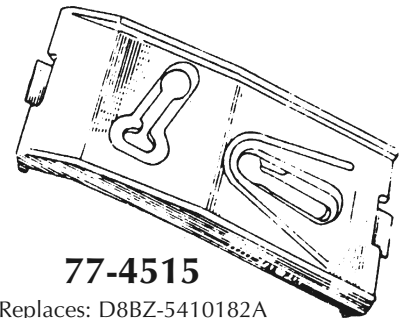

77-4515

Replaces: D8BZ-5410182A
CLIP-FLOOR SIDE MEMBER MOULDING
 Ford '77/
UNIT PACKAGE 100

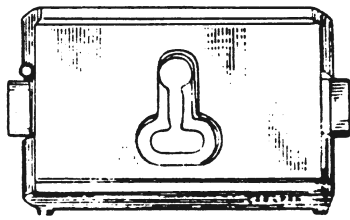

77-4594

Replaces: D8BZ-74425A32-A
**RETAINER-LIFT GATE OUTSIDE
 FINISH MOULDING UPPER REAR**
 Ford Products '78/
UNIT PACKAGE 50

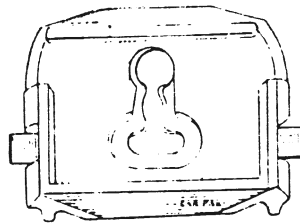

78-4877

Replaces: D9AZ-744257-A
CLIP-TAILGATE LOWER MOULDING
 Ford Products '79/
UNIT PACKAGE 50

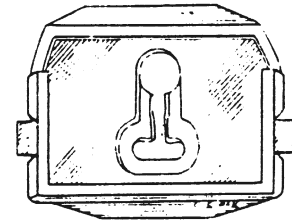

78-4878

Replaces: D9AZ-16D188A
**CLIP-UPPER TAILGATE MOULDING
 & UPPER BODY MOULDING**
 Ford Products '79/
UNIT PACKAGE 50

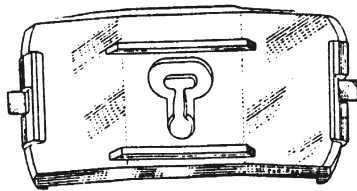

79-5087

Replaces: E0TZ-1021066A
CLIP-BODY SIDE MOULDING
 Ford Light Truck '80/
UNIT PACKAGE 50

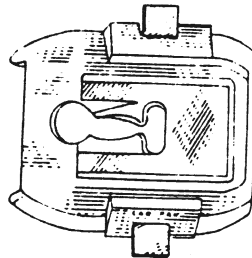

79-5099

Replaces: E0LZ-6620818A
CLIP-DOOR OUTSIDE MOULDING
 Ford Products '80/
UNIT PACKAGE 50

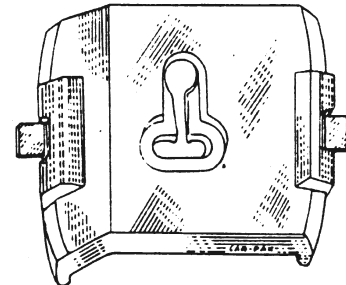

79-5074

Replaces: E0SZ-6610182A
CLIP-BODY MOULDING
 Ford '80/
UNIT PACKAGE 50

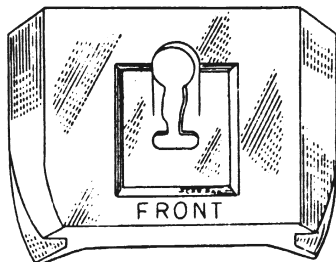

79-5101

Replaces: E0MZ-5429074-A
**CLIP-QUARTER OUTSIDE
 LOWER MOULDING**
 Ford Products '80/
UNIT PACKAGE 25

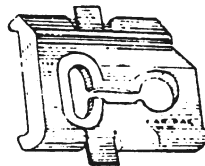

80-5234

Replaces: E1EZ-74208A24A
CLIP-MOULDING
 Ford Escort, Lynx '81/
UNIT PACKAGE 50

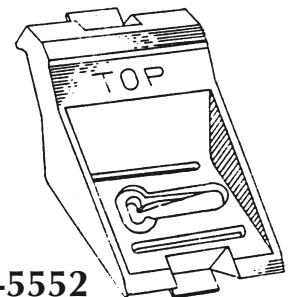

82-5552

Replaces: E3DZ-5421066A
**CLIP-FRONT DOOR
 OUTSIDE MOULDING**
 Ford '83/
UNIT PACKAGE 25

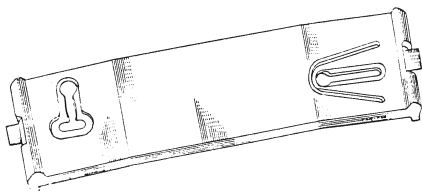

78-4883

Replaces: D9MZ-542166A
**CLIP-FRONT DOOR OUTSIDE
 LOWER MOULDING**
 Ford Products '79/
UNIT PACKAGE 25

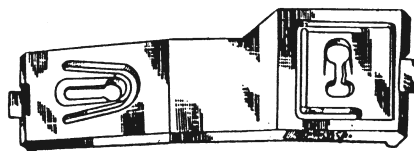

77-4559

Replaces: D3VZ-6510182A
CLIP-ROCKER PANEL MOULDING
 Lincoln '73/
UNIT PACKAGE 50

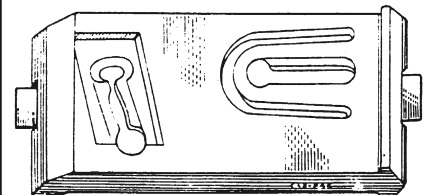

78-4761

Replaces: D5DZ-6620818A
CLIP-ROCKER PANEL MOULDING
 Ford Products '75/
UNIT PACKAGE 50

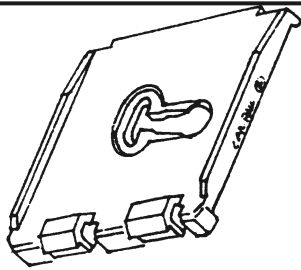
**88-6531**

Replaces: E64Y-5421066A
CLIP-BODY SIDE MOULDING
 Plastic
 Ford Mercury Sable '86/
UNIT PACKAGE 15

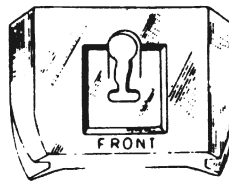
**89-6718**

Replaces: E1VY-5410182-A
CLIP-ROCKER MOULDING
 Plastic
 Lincoln Town Car '84/
UNIT PACKAGE 15

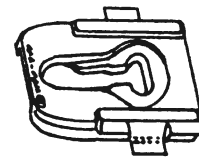
**87-6307**

Replaces: D5UZ-2221066-A
CLIP-BODY SIDE MOULDING LOWER
 Plastic
 Ford Econoline '75/
UNIT PACKAGE 25

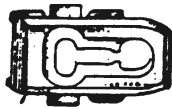
**87-6308**

Replaces: D5UZ-2220818-A
CLIP-BODY SIDE MOULDING, UPPER
 Plastic
 Ford Econoline '75/
UNIT PACKAGE 25

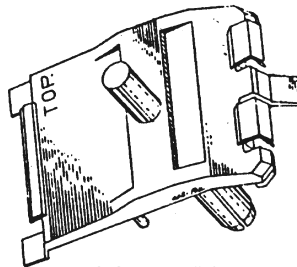
**82-5549**

Replaces: E35Z-6310182A
CLIP-ROCKER PANEL MOULDING
 T-Bird & Cougar XR-7 '83/
UNIT PACKAGE 25

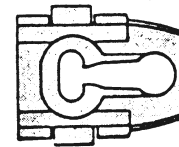
**J04460**

Replaces: D2SB-6520818AB
CLIP-BODY SIDE MOULDING
 Plastic
 Ford & General Purpose
UNIT PACKAGE 50

**J04310**

Replaces: C9AB-6220818A
CLIP-BODY SIDE MOULDING
 Plastic
 Ford & American Motors
UNIT PACKAGE 50

**87-6291**

Replaces: E3TZ-1020818-B
CLIP-BODY SIDE MOULDING
 Plastic
 Ford Ranger '83/
UNIT PACKAGE 10

**71-3537**

RETAINER-SIDE MOULDING
 Ford Country Squire Station
 Wagon '68 - '72
 (60 Per Car)
UNIT PACKAGE 50

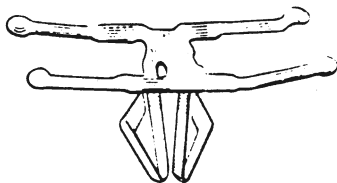
**78-4895**

Replaces: D2DZ-6229120-A
RETAINER-QUARTER PANEL MOULDING
 Maverick '70/
UNIT PACKAGE 50

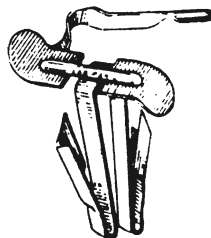
**76-4435**

Replaces: D7LZ-6540368-A
RETAINER-LOWER BACK PANEL MOULDING
 Ford Products '77/
UNIT PACKAGE 50

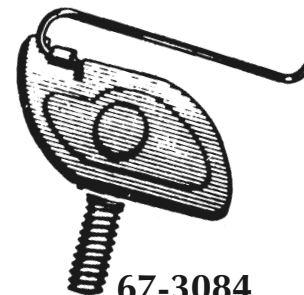
**67-3084**

T-BOLT-BOLT MOULDING
 10 - 24 x 5/8", PLATE: 19/32x1-1/4"
 Ford, Chrysler, G.M. &
 General Purpose
UNIT PACKAGE 50

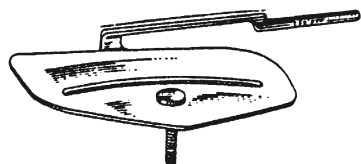
**76-4327**

Replaces: D40Z-16A076G
TEE BOLT-BODY SIDE MOULDING
 8-32 x 0.703, Plate: 1-1/2 x 2-3/8"
 Ford T-Bird & Elite '73/
UNIT PACKAGE 25

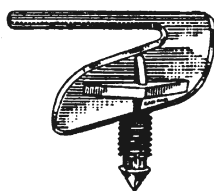
**75-4125**

**TEE BOLT-FRONT BUMPER
 MOULDING RETAINER**
 Plastic
 Mustang '74 - '75
UNIT PACKAGE 50

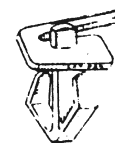
**78-4828**

Replaces: D8SB13C082A
RETAINER-MOULDING
 Plastic
 T-Bird '78/
UNIT PACKAGE 100

**89-6604**

CLIP-BODY SIDE MOULDING
 Tubular Plastic
 Taurus, Sable '86/
UNIT PACKAGE 100

**90-6797**

CLIP-LOWER BODY SIDE MOULDING
 Tubular Plastic Green
 Hole: 3/8"
 Lincoln Town Car '90/
UNIT PACKAGE 25

**99-8095**

Replaces: N806334-S
**GROMMET NUT-FENDER, ROCKER
 MOULDINGS & RUNNING BOARDS**
 Plastic
 Hole: 1/4" Sq., Flange: 3/8" Sq.,
 P.R.: 1/4" Max, Screw: #6
 Ford Mustang, Taurus/Sable,
 Explorer & Expedition '97/
UNIT PACKAGE 50

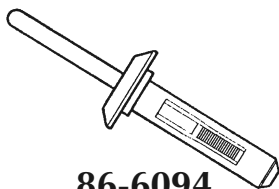
**86-6094**

Replaces: N-803739-S
**BLIND RIVET-INSULATION ATTACH-
 MENT, SHOULDER FORMS A SEAL**
 Super Tough Nylon
 Black Flanged Button Head
 Hole: M6.3, Grip Range: 0.7 - 7.0MM
 Head: 18MM, Shoulder: 2.0
 Ford Taurus & Sable '86/, Aerostar '86/
UNIT PACKAGE 25

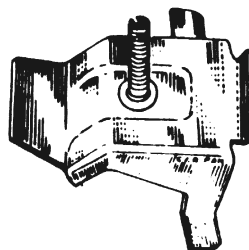
**72-3669**

**RETAINER-HOOD MOULDING
 & General Purpose**
 Ford & G.M. Products
UNIT PACKAGE 25

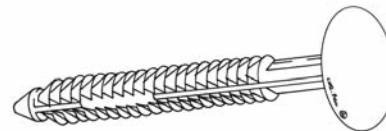
**99-8606**

Replaces: W710532-S300
**RETAINER-ROCKER
 MOULDING**
 Plastic
 Hole: M6.3, Head: 18MM,
 Stem Lgth: 43MM, P.R.: 10.5-37.5MM
 Ford Mustang 2005/
UNIT PACKAGE 25

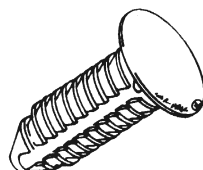
**95-7454**

Replaces: N-807721-S
RETAINER-ROCKER MOULDING
 Hole: M8, Length: 20MM
 Head: 11MM
 Ford Explorer '93/, Mustang '94/
UNIT PACKAGE 50

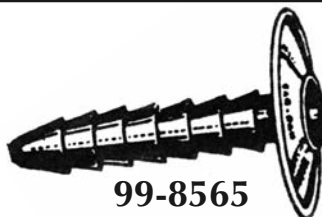
**99-8565**

Replaces: 4001934, 7642589,
 W709883-S300
**RETAINER-FIRE WALL INSULATOR,
 ROCKER MOLDING**
 Plastic, Formerly 72-3642
 Hole: M9.65, Head: 25.4mm,
 Stem Lgth: 36MM
 G.M. '68/ & Ford Mustang 2005/
UNIT PACKAGE 50

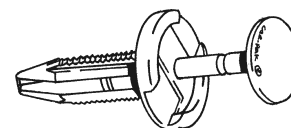
**98-7873**

Replaces: 15149708, W709176-S300
**RIVET-DRIVE TYPE, WHEEL SPLASH &
 LOWER RADIATOR SHIELDS
 & SIDE MOULDING**
 Plastic
 Hole: M6.3, Flange: 17MM, P.R.: 6MM
 G.M. "C/K" Trucks '99/, S/T Truck 2004/
 For Mustang 2005/
UNIT PACKAGE 25

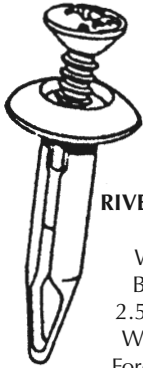

86-6096

Replaces: N-804570-S,
20664092 & 6502790
**RIVET-COWL, INTERIOR TRIM,
GRILLE, ROCKER PNL.,
WHEEL LIP MOULDING**
Black Plastic, Hole: M6.3
2.5MM - 8.0MM Grip Range
Washer Face Dia.: 18.0MM
Ford, G.M., Chrysler Products
& Cadillac '98/
UNIT PACKAGE 25

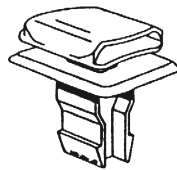

92-7046

Replaces: F1CZ-61101B04-A
**RETAINER-GROUND EFFECTS
PACKAGE**
Sides White Plastic
Ford Escort GT '91/
UNIT PACKAGE 15

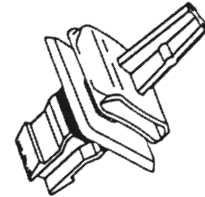

92-7047

Replaces: F1CZ-61101B04-B
**RETAINER-GROUND EFFECTS
PACKAGE**
Sides Yellow Plastic
Ford Escort GT '91/
UNIT PACKAGE 15

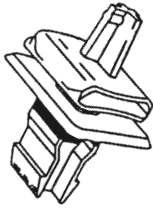

92-7048

Replaces: F1CZ-61101B04-C
**RETAINER-GROUND EFFECTS
PACKAGE**
Sides Red Plastic
Ford Escort GT '91/
UNIT PACKAGE 15

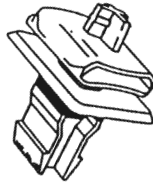

92-7049

Replaces: F1CZ-61101B04-D
**RETAINER-GROUND EFFECTS
PACKAGE**
Sides Purple Plastic
Ford Escort GT '91/
UNIT PACKAGE 15

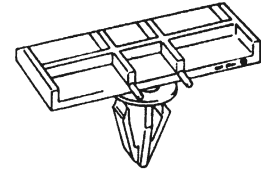

96-7556

Replaces: F1TZ-7810182-A, 12532109
**RETAINER-ROCKER PANEL
GROUND EFFECTS**
Hole: M9
Ford Explorer & Pick-ups '91/
G.M. 'F' Bodies '93/
UNIT PACKAGE 25

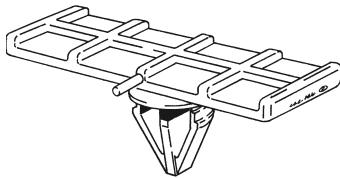

98-7844

Replaces: F4ZZ-6310182-A
CLIP-ROCKER PANEL, GROUND EFFECTS
Plastic-Black
Hole: M9
Ford Mustang '95/
UNIT PACKAGE 25

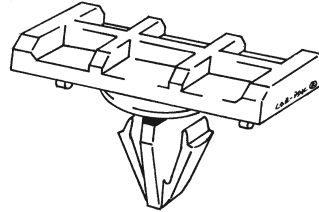

99-8020

Replaces: F6DZ-5410182-AA
RETAINER-Rocker Panel Moulding
Plastic
Hole: M9.5
Ford Taurus/Sable '96/ & Lincoln LS 2000
UNIT PACKAGE 10

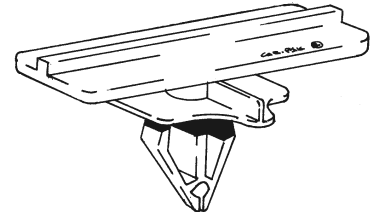

99-8468

Replaces: F57Z-16241-AB, W709767-S300
RETAINER-ROCKER PANEL
Plastic
Hole: M9
Ford Mustang '94/
UNIT PACKAGE 15

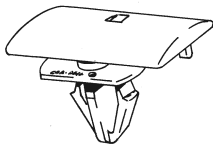

99-8262

Replaces: YL8Z-7820806-AA,
1L8Z-7820806-CA, EC02-51-W24B
**RETAINER - BODY SIDE & ROCKER
MOULDINGS**
Plastic
Hole: M10, Top Head: 13 X 25MM
Slot: 2.5MM
Ford Escape 2001/, Mazda Tribute 2001/
UNIT PACKAGE 10

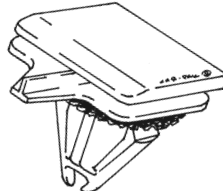

99-8545

Replaces: W710528-S300
RETAINER-SIDE MOULDING
Plastic w/Seal
Hole: M9, Top Head 14x20MM,
O/L: 17MM, P.R.: 0.8MM
Lincoln Navigator 2003/, Mustang 2005/
UNIT PACKAGE 15



99-8757

Not Supplied by O.E.
RETAINER-DOOR CLADDING
Plastic, Grey w/Seal
Hole: M9-10, Stem Lgth: 8.5MM
Ford Edge & Lincoln MKX 2007/
UNIT PACKAGE 10

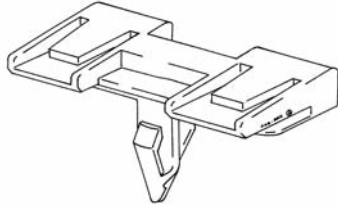

99-8646

Replaces: 6G1Z-5410182-B
RETAINER-UPPER ROCKER MOLDING
 Plastic
 Hole: M9
 Ford Five Hundred 2005/
UNIT PACKAGE 15

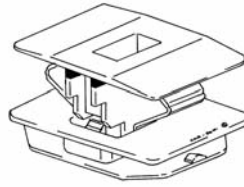

99-8645

Replaces: 6G1Z-5410182-A
RETAINER-LOWER ROCKER MOLDING
 Plastic
 Slot: 9x20MM, Upper Hd: 22x30MM,
 P.R.: 0.8MM
 Ford Five Hundred 2005/, Edge/MKX 2007/
UNIT PACKAGE 15

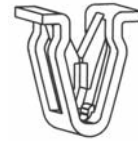

99-8648

Replaces: 6G1Z-5410182-D
RETAINER-ROCKER MOLDING
 Plastic
 Slot: 8.5x16MM
 Ford Five Hundred 2005/
UNIT PACKAGE 25

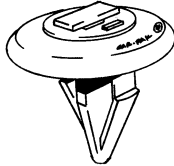

99-8404

Not Supplied BY O.E.
RETAINER-EXTERIOR MOULDINGS
 Plastic
 Hole: M10, Upper Hd.: 4x9.5MM,
 O/L: 16.5MM
 Ford Expedition,
 Explorer/Mountaineer 2001/
UNIT PACKAGE 15



95-7367

Replaces: W700548-S300
SCREW-Philips Pan Head
 Scuff Plate Attaching
 Black Plastic
 M5 x 24MM
 Ford Contour & Mercury Mystique '95/
UNIT PACKAGE 25

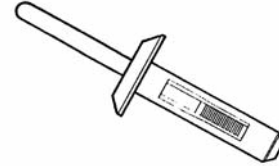

99-8058

Replaces: N805132-S
BLIND RIVET-STILL PLATE ATTACHMENT
 Hole: M4.75, Grip Range: 1.5 - 3.5MM
 Head Dia.: 9.5MM
 Nylon
 Ford Various Models
UNIT PACKAGE 25

FORD PROBE



88-6506

Replaces: GJ21-50-6D7, E92Z 6102316A
PIN- COWL SCREEN RETAINER
 Plastic
 Use W/88-6507 & 88-6508 Grommet
 Mazda 626 & MX6 '88/
 Ford Probe '88/
UNIT PACKAGE 25

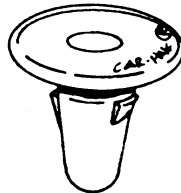

88-6507

Replaces: GJ-21-50-H81
GROMMET-COWL SCREEN RETAINER
 R.H. Plastic
 Use W/88-6506 Pin; Round Opening
 Ford Probe '88/
UNIT PACKAGE 25



88-6508

Replaces: GJ21-50-H82
GROMMET-COWL SCREEN RETAINER
 L.H. Plastic
 Use W/88-6506 Pin; Oval Opening
 Maxda 626 & MX6 '88/
 Ford Probe '88/
UNIT PACKAGE 25



89-6573

Replaces: B003 68 865 96
CLIP-INTERIOR REAR COMPARTMENT
 Hole: M6, Head Dia.: 15MM
 Gray Plastic
 Ford probe '88/, Mazda MX6 '88/
UNIT PACKAGE 50



89-6574

Replaces: B040-68-865-A96, 94530438
RIVET-SCREW TYPE
 INTERIOR TRIM, COWL, FENDER &
 BUMPER
 Hole: M6, Head Dia.: 15MM, P.R. 4-6 MM
 Plastic
 Ford Probe '88 Mazda M6 '88/,
 Chevrolet Aveo 2004/
UNIT PACKAGE 25

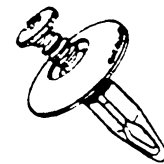

89-6575

Replaces: B100 68 675 69
RIVET-SCREW TYPE
 VARIOUS TRIM APPLICATIONS
 Hole: M6, Head: 20MM, P.R.: 5-10 MM
 Plastic
 Ford Probe '88/ Mazda MX6 '88/
UNIT PACKAGE 15

**94-7319**

Replaces: BO92-51-833, W705845-S300,
86590-28000

**RIVET-SCREW TYPE HEADLAMP
SPLASH SHIELD, COWL VENT**

Hole: M8, Flange: 18MM, P.R.: 3-7MM
Plastic

Ford Probe '89-'92, Escape '01/
Mazda '99/ & Hyundai/Kia
UNIT PACKAGE 25

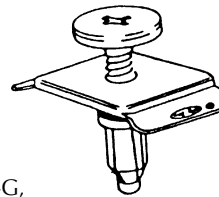
**90-6766**

Replaces: E7GZ-17A904-G,
BF82-50-233, & MBF82-50-233
**RIVET-SCREW TYPE FRONT & REAR
BUMPER COVER**

Hole: M10, P.R.: 7-12MM
Ford Escort, Mercury Tracer '87/
Mazda 323 '87/
Kia Spectrum, Sportage '93/
UNIT PACKAGE 10

90-6767

Replaces: E7GZ-17A904-B & BF67-50-033

**RIVET-SCREW TYPE
REAR BUMPER COVER**

Hole: M10, P.R.: 3-7MM
Mercury Tracer '87/, Mazda 323 '87/
UNIT PACKAGE 10

**90-6728**

Replaces: E92Z-17C756-C
GJ21-50-034

**RIVET-SCREW TYPE
REAR BUMPER COVER ASSY.**

Plastic
Hole: 10, Hex Screw w/Phillips Type
Recess

Ford Probe, Mazda MX6 '89/
UNIT PACKAGE 15

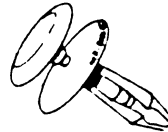
**89-6576**

Replaces: B101 68 252 00

**RIVET- DRIVE TYPE
INTERIOR TRIM VARIOUS**

Hole: M5, Head Dia.: 14 MM,
P.R.: 5-9 MM
Black Plastic

Ford Probe '88/, Mazda MX6 '88/
UNIT PACKAGE 25

**89-6579**

Replaces: GJ2158 885 A69,
6E5Z-7850980-AAA (Black)

**RIVET-DRIVE TYPE
INTERIOR TRIM REAR COMPARTMENT,
FRONT LAMPS**

Hole: M6 , Head Dia.: 18MM, P.R.: 2MM
Gray Plastic (Paint to Match)

Ford Fusion, Zepher & Milan 2006/
Ford Probe, Mazda MX6
UNIT PACKAGE 25

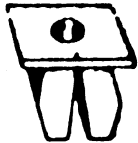
**89-6585**

Replaces: 99910 0501, 14910-05000

**GROMMET NUT-ROCKER PANEL,
FRONT BUMPER**

Screw M4.2, Hole: 8MM sq.
Plastic

Ford Probe '88, Mazda MX6 '88/
Hyundai '86/
UNIT PACKAGE 50

**96-7511**

Replaces: F1CZ-16774-A, B455-56-741

CLIP-HOOD INSULATION

Black Plastic
Hole: M6, Length: 10MM,
Head Dia.: 14MM

Ford Probe '88-'92, Mazda MX6 '88-'92
UNIT PACKAGE 25

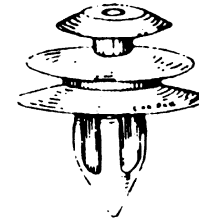
**89-6586**

Replaces: KA01 68 401, H260-68-401

CLIP-DOOR INTERIOR TRIM PANEL

Plastic
Ford Probe '88/ Mazda MX6 '88/
UNIT PACKAGE 25

**89-6584**

Replaces: SO83 68 865A96
**CLIP-INTERIOR TRIM CARPET
& SEAT BACK**

Gray Plastic
Use W/89-6577

Ford Probe '88/, Mazda MX6 '88/
UNIT PACKAGE 25

**89-6577**

Replaces: G032 68 866A
GROMMET-TRIM INTERIOR

Plastic
Ford Probe '88/, Mazda MX6 '88/
UNIT PACKAGE 25

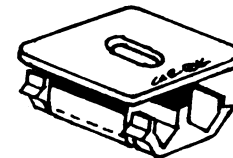
**89-6583**

Replaces: KA01 68 241
CLIP-ROOF GARNISH MOULDING

Plastic
Ford Probe '88/ Mazda MX6 '88/
UNIT PACKAGE 15

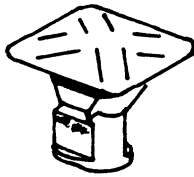

89-6581

Replaces: KA01 50 H15
CLIP-REAR HATCH
 Plastic
 Use W/89-6582
 Ford Probe '88/, Mazda MX6 '88/
UNIT PACKAGE 25

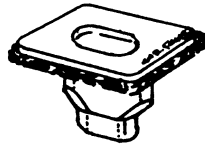

89-6582

Replaces: KA01 50 H16
GROMMET REAR HATCH
 Plastic Use w/89-6581
 Ford Probe '88/ Mazda MX6 '88/
UNIT PACKAGE 15

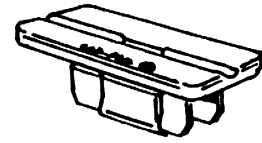

89-6580

Replaces: H 001 68 719B
RETAINER-ROCKER SCUFF PLATE
 Plastic
 Ford Probe '88/, Mazda MX6 '88/
UNIT PACKAGE 25

GARNISH / HEADLINER AND INTERIOR MOULDINGS

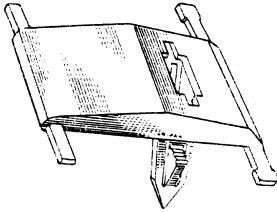

76-4392

Replaces: D74Z-5442468-A
CLIP-BACK WINDOW SIDE
GARNISH MOULDING
 Ford Products '77/
UNIT PACKAGE 50

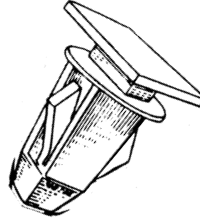

79-5083

Replaces: E0LZ-5442468-A
RETAINER-REAR GLASS GARNISH
MOULDING
 Lincoln '80/
UNIT PACKAGE 25



77-4726

Replaces: D60Z-6551026-A
CLIP-HEADLINER LISTING WIRES
 Ford Products '76/
UNIT PACKAGE 50

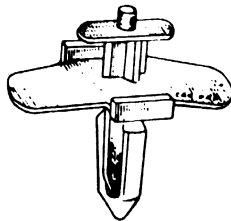

78-4786

Replaces: 387420-A
CLIP-HEADLINING MOULDING
 Ford Vans '78/
UNIT PACKAGE 50

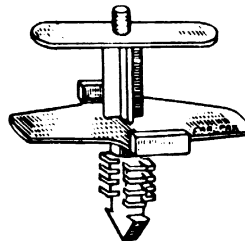

78-4785

Replaces: D8BZ-74517C06A
CLIP-HEADLINING MOULDING
 Ford Vans '78/
UNIT PACKAGE 50

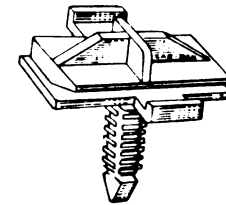

78-4791

Replaces: D9AZ-74519B18A
CLIP-HEADLINING MOULDING
 Plastic
 Ford Products '79/
UNIT PACKAGE 50

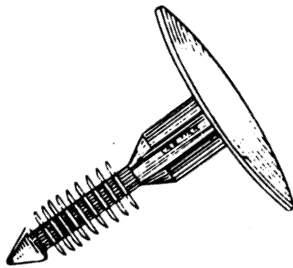

78-4838

Replaces: N-800387-S
RETAINER-DASHBOARD ATTACHING
 Ford Products '79/
UNIT PACKAGE 50

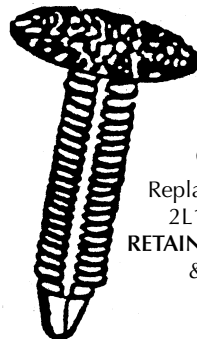

86-6097

Replaces: N-804349-S,
 2L1Z-7852140-AA
RETAINER-INTERIOR TRIM
& HEADLINER
 Black Plastic
 Hole: M7
 Grip Range Up To 30.0MM
 Head Dia.: 25.0MM
 Ford
UNIT PACKAGE 25

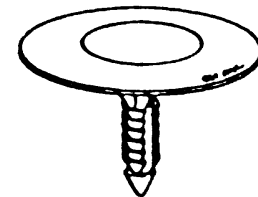

91-6970

Replaces: N-805315
RETAINER-HEADLINER
 Hole: M7, Head: 32MM,
 Stem Length: 20MM
 Gray Plastic (Paint to Match)
 Ford Aerostar '86/
UNIT PACKAGE 15

**97-7724**

Replaces: N805200-S
**RETAINER-HEADLINER,HOOD
 INSULATION**
 Plastic-Black Textured
 Hole: M8, Head Dia: 32MM
 Stem Lgth: 20MM
 Ford TBird, Cougar '87/, Explorer '91,
 Lincoln Continental '95/
UNIT PACKAGE 15

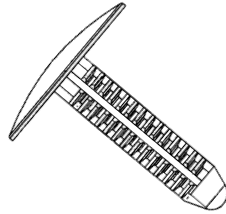
**99-8412**

Replaces: XW7Z-6302354-AAB
RETAINER-HEADLINER
 Plastic-Textured, Paint to match
 Hole: M7, Head: 25.4MM,
 Stem Lgth: 29MM, P.R.: 3-18MM
 Ford Expedition, Navigator 2003
UNIT PACKAGE 25

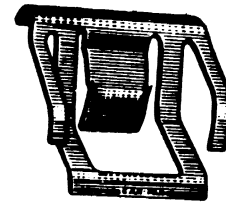
**72-3735**

Replaces: D20Z-6551756-A
CLIP-INSIDE ROOF RAIL
 Ford Torino '72/ - '73
UNIT PACKAGE 50

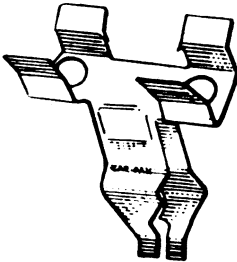
**79-5027**

CLIP-DASH PADS
 Ford Econoline & Vans '75/
UNIT PACKAGE 50

**77-4541**

Replaces: 386413-S2
NUT-HEATER & AIR CONTROL UNIT
 8 - 18
 Black
UNIT PACKAGE 100

**98-7841**

Replaces: F5AZ-14570-A
**CLIP-DOOR LOCK &
 POWER WINDOW SWITCH**
 Metal
 Ford '95/
UNIT PACKAGE 25

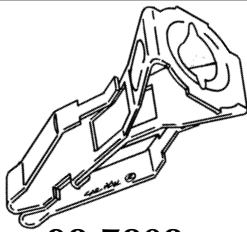
**98-7808**

Replaces: N804741-S2, N806031-S32B
**RETAINER- INSTRUMENT PANEL,
 DOOR TRIM**
 Cluster Opening
 Ford "A", "MA" & Truck '96/ Flex 2009,
 Mustang '94-2004
UNIT PACKAGE 10

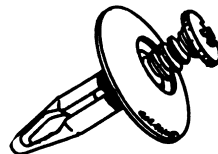
**87-6297**

Replaces: N-804837-S
RIVET SCREW TYPE-TRIM ATTACHMENT
 VARIOUS INTERIOR
 Hole: M6.3, Flange: 25MM, P.R.: 2-12MM
 Black Plastic
 Ford Taurus & Sable
UNIT PACKAGE 25

**95-7419**

Replaces: N-806322-S
**RIVET-SCREW TYPE, VARIOUS
 TRIM PANELS**
 Hole: M6.3, Head: 18MM,
 P.R.: 2.7 - 4.2MM,
 Stem Length: 13MM
 Plastic
 Ford Vehicles
UNIT PACKAGE 15

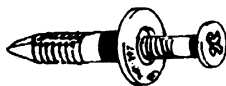
**95-7420**

Replaces: N-808332-S, N-807578-S
**RIVET-SCREW TYPE, VARIOUS
 TRIM PANELS**
 Hole: M6.3, Head: 18MM,
 P.R.: 7.0 - 10MM, Stem Length: 19MM
 Plastic
 Ford Vehicles
UNIT PACKAGE 15

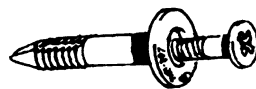
**95-7421**

Replaces: N-808331-S, N-807577-S
**RIVET-SCREW TYPE, VARIOUS
 TRIM PANELS**
 Hole: M6.3, Head: 18MM,
 P.R.: 13.5 - 15.5MM,
 Stem Length: 27.5MM
 Plastic
 Ford Vehicles
UNIT PACKAGE 15

**87-6193**

Replaces: N-803825-S, N-803196-S
 6503453
**RIVET-DRIVE TYPE, VARIOUS
 TRIM ATTACHMENTS**
 Hole: M6.3, P.R.: 5.0 - 12.0MM,
 Head: 24MM
 Ford Products '84/, Jeep Gr. Cherokee '94/
UNIT PACKAGE 25

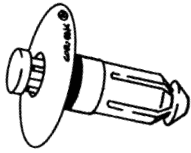

99-8112

Replaces: 5GC71RC3AA, 5GF92RC3AA, N808791

RIVET - DRIVE TYPE, INTERIOR TRIM, DASH & CONSOL

Plastic, Push To Release

Hole: M9, Shoulder: 10 x 6.8MM,

Flg.: 19MM

Dodge Durango '98/, Ford Pick Ups '97/
UNIT PACKAGE 25

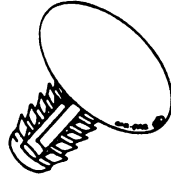

96-7590

Replaces: W-700673-S300

RETAINER-INSTRUMENT PANEL, RADIATOR SIDE SHIELD

Sq. Hole: M7.2, Head: 20.2MM,

Stem Length: 14MM, Barb Length: 8MM
Black Plastic

Ford Contour, Mercury Mystique '95/
UNIT PACKAGE 25

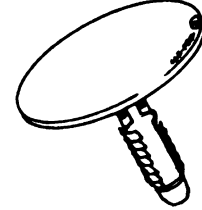

96-7549

Replaces: N-803387-S
RETAINER-TRIM PANEL

Hole: 1/4", Head: 1-3/4",
Stem Length: 1"

Black Plastic

Ford
UNIT PACKAGE 25

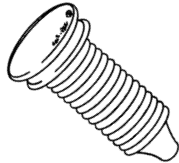

99-8110

Replaces: N807943-S

RETAINER-INTERIOR TRIM

Hole: M7, Upper Head: 13MM,
Lower Head: 12MM P.R.: 0.8-10MM
Plastic

Ford Mustang '95/
UNIT PACKAGE 25



99-8769

Replaces: W713590-S300

RETAINER-WINDSHIELD MOULDING
Plastic-White, w/Seal

Hole: M9, Top Head: 14x18MM,
O/L: 15MM

Ford Flex 2009/
UNIT PACKAGE 15



99-8772

Replaces: W790173-S900

RETAINER-WINDSHIELD MOULDING
Plastic-Blue, w/Seal

Hole: M9, Top Head: 14x18MM,
O/L: 15MM

Ford Flex 2009/
UNIT PACKAGE 10

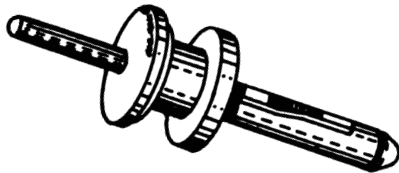

87-6313

Replaces: N804134-S

BLIND RIVET-SUPER TOUGH NYLON TRIM ATTACHMENTS

Double Head, Hole: 6.3MM,
P.R.: .05-3.5MM, Head: 16.8MM

Shoulder: 16.8MM

Ford Taurus & Sable '86/
UNIT PACKAGE 25

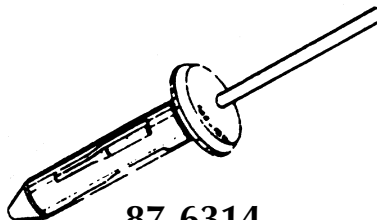

87-6314

Replaces: N-804675-S

BLIND RIVET-SUPER TOUGH NYLON, FASCIA ATTACHMENTS

Hole: M6.3, P.R.: 8 - 13MM,
Head: 17MM

Ford
UNIT PACKAGE 25

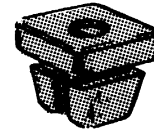

87-6250

GROMMET-VARIOUS APPLICATIONS

Screw: M6, Hole: M9, P.R.: 3.0 - 4.0MM,

Flange: 15MM

Black Plastic

Ford, Chrysler
UNIT PACKAGE 25

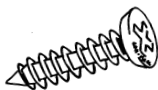

97-7679

Replaces: W703488-S309
SCREW- PHILLIPS UNDERCUT FLAT HEAD

M4.2 x 18MM w/Oversized 9MM Head

Various Interior Trim

Yellow Chromate

Ford Contour, Mystique '95/
UNIT PACKAGE 25

**REGISTERED USERS
GET UPDATES AT:
www.carpak.com**

GRILLE / COWL & SPLASH SHIELD

**72-3616**

Replaces: 283333-S 100
GROMMET-GRILLE TO STONE SHIELD
 Maverick '70 - '72
UNIT PACKAGE 100

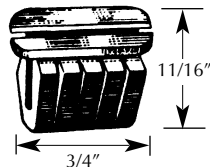
**78-4819**

Replaces: 1264963, 10032838
 8934-201-602, 6031869
**GROMMET-MULTI PURPOSE HOOD
 HINGE GRILLE & FLOOR TRIM RET.**
 Buick '79/, Fiero '84/, Chrysler
 AMC Alliance & Ford Truck
UNIT PACKAGE 50

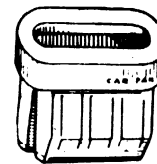
**80-5173**

Replaces: N800841-S
GROMMET-GRILLE RETAINING
 Screw: M4.2
 Mustang '80/
UNIT PACKAGE 50

**79-4980**

Replaces: D9BZ-5402316-A
**GROMMET-DASH PANEL & GRILLE
 RETAINING**
 Hole: M7, Screw: M4.2
 Ford Full Size Cars, Ranger, Aerostar,
 Explorer & "E" Vans '79/
UNIT PACKAGE 50

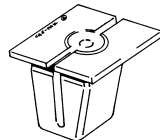
**99-8155**

Replaces: YS4Z-13N129-AA
**GROMMET-HEADLAMP
 MOUNTING AT GRILLE OPENING**
 Plastic
 Screw: M4.2, Hole: 10x13.5MM,
 Flange: 20MM sq.
 Ford Focus 2000/
UNIT PACKAGE 15

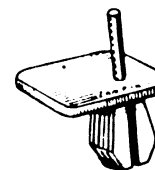
**78-4795**

RIVET-DRIVE TYPE, GRILLE MOULDING
 Plastic
 Ford Trucks '78/
UNIT PACKAGE 50

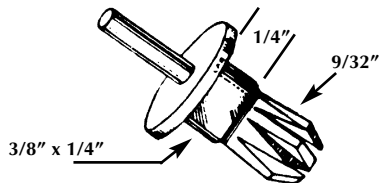
**78-4790**

Replaces: 387944-S
RIVET-DRIVE TYPE, GRILLE RETAINING
 Flange: 23/32"
 Plastic
 Ford Trucks & Vans '78/
UNIT PACKAGE 50

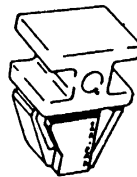
**91-6898**

Replaces: F1CZ-8A188-A
RETAINER-RADIATOR GRILLE
 Plastic
 Ford Escort & Tracer '90/
UNIT PACKAGE 25

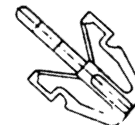
**88-6499**

Replaces: 90467-12020, H200-50-715
 BF67-50715, 75103-SJ4-003
CLIP-GRILLE & HEADLAMP DOOR
 Gray Plastic
 Toyota Corolla '83/, Chevrolet Nova '86/
 Mazda 323 '86/, Ford Festiva & Tracer '88/
 Honda Accord '90-'93, Ford Explorer '96/
UNIT PACKAGE 25

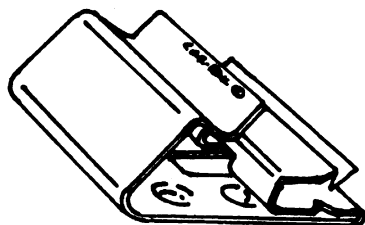
**88-6517**

Replaces: N803748-S100
CLIP-GRILLE
 Ford Crown Victoria
 & Tempo '88/, Mercury Grand
 Marquis & Topaz '88/
UNIT PACKAGE 15

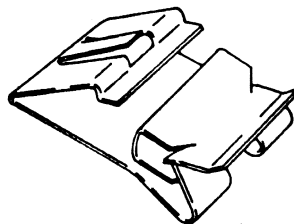
**96-7559**

Replaces: N807455-S100
CLIP-LOWER GRILLE
 Ford Explorer '96/
UNIT PACKAGE 15

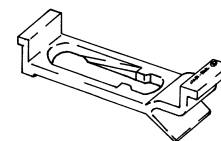
**99-8141**

Replaces: YF4Z-8194-AA
CLIP-RADIATOR GRILLE
 Plastic
 Mercury Sable 2000/
UNIT PACKAGE 15



99-8026

Replaces: 384051-S, 480534
**RETAINER-COWL SPLASH SHIELD
 & WIRE RETAINER**
 Plastic

(Formerly 69-3292)
 Hole: M6.3, Head: 10 x 25MM, PR: 1-9MM
 Ford & G.M. '70/
 UNIT PACKAGE 50



99-8054

Replaces: 391349-SS
RETAINER-COWL VENT
 Plastic w/Matte Finish

Hole: M6.3, Head: 17.4MM, O/L: 22.2MM
 Ford Full Size '92/
 UNIT PACKAGE 50

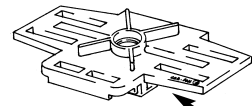

COWL SIDE
 CLIP



99-8235
 RETAINER

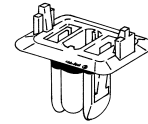

BODY SIDE
 GROMMET

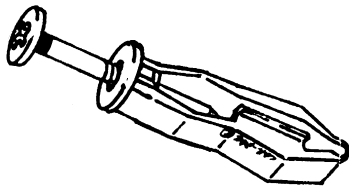

95-7375

Replaces: W703842-S300, W703919-S300
GROMMET & SCREW ASSEMBLY
 COWL GRILLE

Hole: 8MM x 10MM, Plastic w/Metal Screw
 Washer Face: 11MM, G.R.: 0.8 - 3.0MM
 Ford Contour & Mercury Mystique '95/
 Cougar '99/
 UNIT PACKAGE 5



Cap

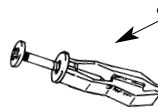

95-7375

96-7591

Replaces: W701223-S300
CAP
 Plastic-Black

Use w/Exterior Cowl Screw #95-7375
 Fits 9MM Screw Head
 Ford Contour & Mercury Mystique '95/
 UNIT PACKAGE 25

99-8235

Not Supplied By OE
RETAINER - COWL VENT
 Plastic
 Ford Focus 2000/
 UNIT PACKAGE 25

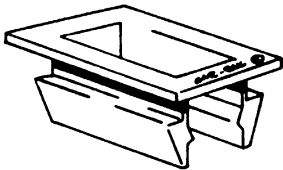

96-7562

Replaces: W701650S, F6DZ-5402316-A,
 F7DZ-5402316-AA
GROMMET-COWL

Use w/98-7806, 99-7918
 Hole: 9 X 12.1MM
 Ford Taurus, Sable '96/
 UNIT PACKAGE 50

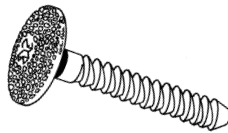

98-7806

Replaces: W701649-S, W704881-S300
RETAINER-COWL
 (Phillips Style Recess)

Plastic
 Formerly 96-7561

Stem Lgth: 26MM, Head: 14MM
 Use with 96-7562
 Ford Taurus, Sable '96/
 UNIT PACKAGE 50

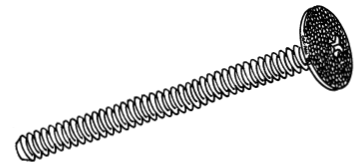

99-7918

Replaces: N811849-S300
RETAINER - COWL
 (Phillips Style Recess)

Stem Lgth:52MM, Head:14MM
 Use with 96-7562
 Lincoln Town Car '98/
 UNIT PACKAGE 15

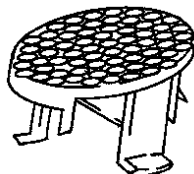

98-7764

Replaces: F65Z-15020C34-AA
COVER-SCREW COWL VENT
 Plastic-Black

Ford F150, Expedition & Navigator '97/
 UNIT PACKAGE 25

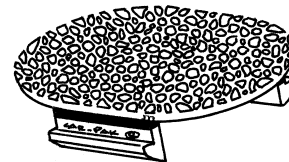

97-7752

Replaces: F1CZ-5802316-C
COVER - COWL SCREW

Large Oval
 Plastic

Ford Escort '91/
 UNIT PACKAGE 15

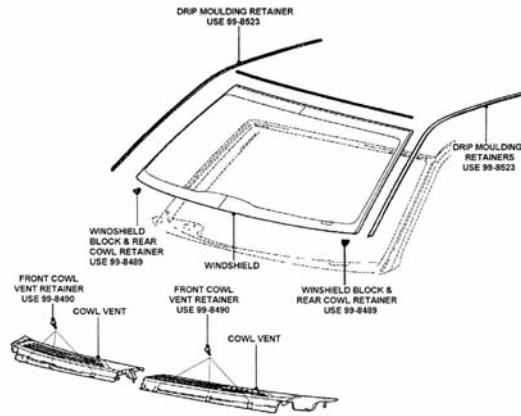

**COWL and WINDSHIELD
RETAINERS for
THE 'NEW' STYLE
FORD PICK-UPS 2004/**

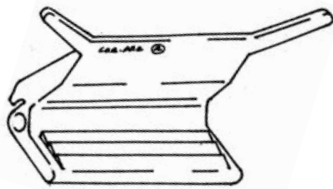

99-8523

Replaces: 4L3Z-1510182-AA
**RETAINER-ROOF &
GARNISH MOULDING**
Plastic
Ford 'F' Pick-ups 2005
UNIT PACKAGE 15

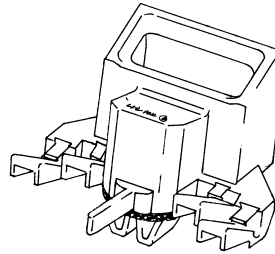

99-8489

Replaces: 4L3Z-1503296-AB,
BLOCK-WINDSHIELD SETTING
Plastic w/Seal
Ford Pick Up Truck '2004/
UNIT PACKAGE 5

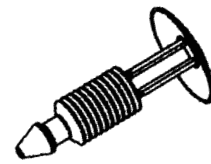

99-8490

Replaces: W710312-S300
RETAINER-COWL VENT
Plastic-Textured
Hole: M7.5 or M6.3x8.0MM Slot, Head:
18MM,
Stem Lgth.: 32MM, P.R.: 12-19MM
Ford Pick Up Trucks 2004
UNIT PACKAGE 25



93-7151

Replaces: BWOA-50-792, FICZ-5802316-A
GROMMET-COWL SCREEN w/SEALER
Hole: M10, Screw: M4
Flange: 24 x 24MM
Ford Escort & Tracer '91/ & Escape 2001/
UNIT PACKAGE 15

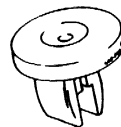

95-7368

Replaces: W700505-S300
**GROMMET NUT-COWL & VARIOUS TRIM
PANELS**
Hole: 11.5 x 8.2MM, Screw: 4.8MM
Flange: 20MM
Plastic
Ford Contour & Mercury Mystique '95/
UNIT PACKAGE 25

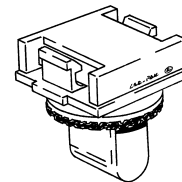

99-8009

Replaces: N807189-S100, N811353-S100
GROMMET-COWL VENT
Plastic
Hole: 10 x 15MM, P.R.: .75-1.2MM,
Screw: M4.2
Ford "F" Pick-up, Expedition &
Windstar '95/
UNIT PACKAGE 10

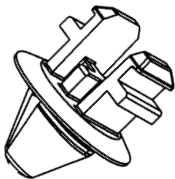

99-8347

Replaces: W708771-S300
**RETAINER - RADIATOR SHROUD AIR
DEFLECTOR & COWL VENT**
Plastic
Hole: 10 X 15MM Slot, O/L: 24MM,
P.R.: 1MM
Ford Expedition & Excursion 2003/
UNIT PACKAGE 50

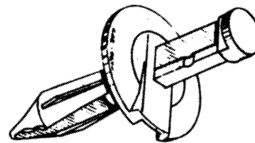

83-5636

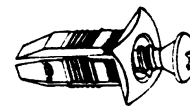

Replaces: N802781-S, W704340-S300
14093088
**RIVET-DRIVE TYPE, COWL, INTAKE
SPLASH SHIELD**
GRILLE & FRONT BUMPER
Hole: M6.3, Flange: 25MM
Black Plastic
Ford '83/, G.M. Cars & Trucks '84/
UNIT PACKAGE 25



M6 Sq. Hole

85-5948

Replaces: N803494-S, 15679091
**RIVET-SCREW TYPE, VARIOUS FASCIA
& GRILLE ATTACHMENT**
Black Plastic
Lgt. Truck, Escort, Lynx '86/
G.M. "S" Truck '94/
UNIT PACKAGE 50

 <p>86-6096 Replaces: N-804570-S, 20664092 & 6502790 RIVET-COWL, INTERIOR TRIM, GRILLE, ROCKER PNL., WHEEL LIP MOULDING Black Plastic, Hole: M6.3 2.5MM - 8.0MM Grip Range Washer Face Dia.: 18.0MM Ford, G.M., Chrysler Products & Cadillac '98/ <i>UNIT PACKAGE 25</i></p>	 <p>94-7319 Replaces: BO92-51-833, W705845-S300, 86590-28000 RIVET-SCREW TYPE HEADLAMP SPLASH SHIELD,COWL VENT Hole: M8, Flange: 18MM, P.R.: 3-7MM Plastic Ford Probe '89-'92, Escape '01/ Mazda '99/ & Hyundai/Kia <i>UNIT PACKAGE 25</i></p>	 <p>89-6587 Replaces: N805295-S, N805229-S, 22595587 RIVET-SCREW TYPE, LICENSE PLATE LAMP COWL & VARIOUS TRIM Hole: M5, P.R.: 4 - 8MM Plastic Ford '88/, G.M. <i>UNIT PACKAGE 25</i></p>
 <p>99-8600 Replaces: 3M8Z-1502316-A, GJ6E-50-715A RIVET-SCREW TYPE, COWL VENT Plastic Hole: M5, Flange: 8.5x12MM, Stem Lgth: 8.7MM, P.R.: 5MM Max Ford Fusion, Milan & Zephyr 2006 Mazda 5 & 6 2003/ <i>UNIT PACKAGE 15</i></p>	 <p>95-7462 Replaces: 91545-SE0-003 & 63848-01G00-A RIVET-DRIVE TYPE, COWL GRILLE Hole: M8, Washer Head: 20MM Length: 14MM Honda Accord '90/, Nissan Trucks '87/ Mercury Villager Maxima thru '98 <i>UNIT PACKAGE 15</i></p>	 <p>99-8265 Replaces: W705956-S300, XR8 7508 RIVET - DRIVE TYPE (PUSH TO RELEASE) Cowl Grille & Lower Radiator Opening Cover Plastic w/seal Hole: M9, Shoulder: 3 X 10MM, Flange: 25MM, Stem Lgth: 13MM Lincoln LS 2000/, Jaquar 'S' Type '01/ <i>UNIT PACKAGE 10</i></p>
 <p>86-6092 Replaces: N-804583 BLIND RIVET-COWL VENT GRILLE RETAINING Super Tough Nylon Rectangular Head: 8.0MM x 15.0MM Rivet Dia.: 3.96MM Grip Range: 6.0 - 10.5MM Rectangular Hole: 8.0 x 6.0MM Ford Aerostar '86/ <i>UNIT PACKAGE 25</i></p>	 <p>99-8051 Replaces: 387843-S RIVET-DRIVE TYPE, INNER FENDER SPLASH SHIELD TO BODY General Purpose Hole: 1/4", Flange: 9/16" Ford Products '78/ <i>UNIT PACKAGE 25</i></p>	 <p>89-6716 RIVET-DRIVE TYPE, FRONT STONE DEFLECTOR PANEL Hole: M6.4 Sq., P.R.: 3.0 - 6.0MM Black Plastic Ford Bronco II & Ranger '89/ <i>UNIT PACKAGE 25</i></p>
 <p>83-5663 Replaces: E3DZ-14A163A, 14019205, 14019206, 8934-201-621 RIVET-DRIVE TYPE, GENERAL PURPOSE Hole: 1/4", P.R.: 1/8" - 1/4" Flange: 11/16" Black Plastic Ford, G.M., American Motors <i>UNIT PACKAGE 25</i></p>	 <p>89-6702 Replaces: N805231-S RIVET-DRIVE TYPE, GRILLE OPENING REINFORCEMENT Hole: M6.4, Flange: 16MM P. R.: 4.8 - 8.4MM Black Plastic Ford Taurus, Topaz & Sable '89/ <i>UNIT PACKAGE 50</i></p>	 <p>84-5841 Replaces: N803421-S, 6501590 DRIVE RIVET-FASCIA ATTACHMENTS Hole: M6, w/M8 Shoulder Flange: 25MM Ford '84/, Chrysler "LH" '93/ <i>UNIT PACKAGE 50</i></p>

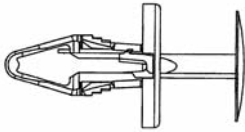
**99-8578**

Replaces: 11589290, W714040-S300
RIVET-DRIVE TYPE,
 COWL VENT & BUMPER, Plastic
 Hole: M6.25-6.53, Flange: 18MM,
 Stem Lgth: 20MM, P.R.: 4.5-7.0
 G.M. 'A' 'W', 'L', 'M', G5 Body 2005/
 C/K Truck & SUV 2007/, Saturn Sky
 2007/, Ford Flex 2009
UNIT PACKAGE 50

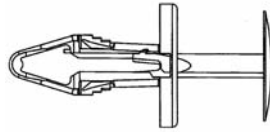
**99-8695**

Replaces: 11589291, W713331-S300
RIVET-DRIVE TYPE,
 AIR DAM & GRILLE
 Plastic
 Hole: M6.25-6.53, Flange: 18MM,
 Stem Lgth: 22MM, P.R.: 7-9.5MM
 G.M. 2006/ & Ford
UNIT PACKAGE 25

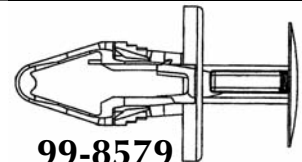
**99-8579**

Replaces: 11589293, W712196-S300
RIVET-DRIVE TYPE,
 COWL VENT, FENDER & BUMPER Plastic
 Hole: M8.25-8.53, Flange: 20MM,
 Stem Lgth: 21.5MM, P.R.: 4.5-7.0
 G.M. 'W', 'N' Body & Hummer 2005/
 Full Size SUV & Suburban 2007/
 Ford Edge/MKX 2007/, Flex 2009
 Fusion/MKZ/Zephyr/Milan2006/
UNIT PACKAGE 25

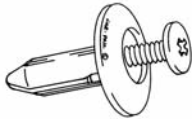
**99-8767**

Replaces: W706092-S300,
 6508197AA, 2028654C1
RIVET-SCREW TYPE,
 SHIELDS & GRILLES, Plastic
 Hole: M6.4-6.9, Flange: 17.8MM,
 Stem Lgth: 18MM, P.R.: 3-5MM
 Ford Taurus 2008/
 Dodge PU 2002/ & Navistar
UNIT PACKAGE 25

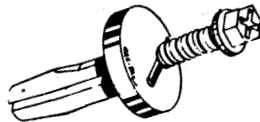
**84-5788**

Replaces: N-802737-S
RIVET-SCREW TYPE, FENDER CROSS
 PANEL TO FAN SHROUD
 Hole: M6, Flange: 19MM
 Ford Tempo-Topaz '84/
UNIT PACKAGE 50

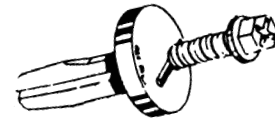
**91-6890**

Replaces: N805660-S, 14019226
RIVET-SCREW TYPE
 Hole: M8, Head: 17MM
 P. R.: 4 - 8MM
 Ford, G.M. & General Usage
UNIT PACKAGE 25

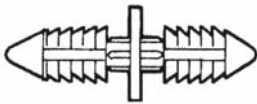
**99-8546**

Not Supplied by O.E.
RETAINER-GRILLE SHROUDS
 Plastic
 Hole: M6.35(1/4"), Flange: 12.7MM(1/2"),
 P.R.: 2.3-6.8MM Both ends
 Ford Explorer, Mountaineer
 & General Purpose
UNIT PACKAGE 25

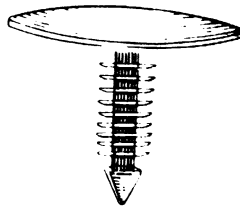
**81-5310**

Replaces: 388904-S, 389443-S,
 N802224-S, 43813955, 6501086
CLIP-FRONT & REAR BUMPERS
 COVER TO BAR
 Ford Products & Chrysler '84/
UNIT PACKAGE 100

**78-4840**

Replaces: N-800505-S
RETAINER-RADIATOR ATTACHING
 Hole: M4.75, Head: 11MM
 P.R.: 5-29MM, Stem Lgth.: 35MM
 Ford Products
UNIT PACKAGE 50

**77-4692**

Replaces: 387258-S, 20032850, 3861577
RETAINER-STONE SHIELD
 Ford, Chrysler & G.M. Products '76/
UNIT PACKAGE 100

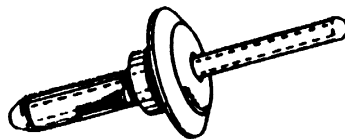
**90-6763**

Replaces: N8062996-S
BLIND RIVET-SUPER TOUGH NYLON
 FRONT STONE DEFLECTOR
 Hole: M6.3, Head: 17MM
 Shoulder: 9.5MM, G.R.: 4 - 10MM
 Black
 Lincoln '90/
UNIT PACKAGE 25

**99-8025**

Replaces: 15002519, 25768356,
 N800488-S301, W706675-S301,
 2L8Z-7820806-DA
NUT-THREAD CUTTING
 Grille Emblem & Moulding, Side Marker
 M5 x 10MM Hex
 w/15MM Toothed Integral Washer,
 Finish: Zinc
 G.M. Cobalt 2005/, S/T & "K" Trucks '96/
 Ford Taurus/Sable, Escape 2001/
 Edge/MKX 2007/
UNIT PACKAGE 100

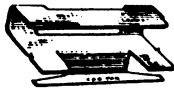

72-3758
CLIP-FRONT FENDER SPLASH SHIELD
 Ford '73/
 UNIT PACKAGE 50

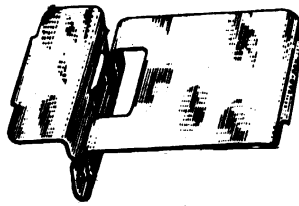

72-3757
CLIP-FRONT BUMPER PLASTIC SPLASH SHIELD
 Ford '73/
 UNIT PACKAGE 50

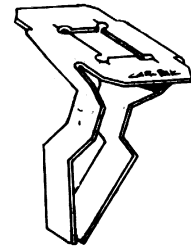

83-5717
 Replaces: N-802606S32B, N804192-S
RETAINER-STAND OFF
 Ford Tempo & Mercury Topaz '84/
 UNIT PACKAGE 25

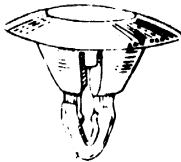

79-5108
 Replaces: 800737-S
PIN-PUSH TYPE
 Plastic
 Hole: M6.3, Head: 22MM, O/L: 17MM
 Ford Products
 UNIT PACKAGE 100

SEE
www.carpak.com
FOR UPDATED
O.E. CROSS-REFERENCES

BUMPER / LIGHT / TRUNK



78-4800
 Replaces: D6FY-1A100A
RIVET-DRIVE TYPE, USED ON ALUMINUM WHEELS
 Ford Products '76/
 Lincoln Mercury '76/
 UNIT PACKAGE 25

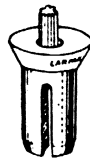

78-4967
RIVET-DRIVE TYPE, ALUMINUM WHEELS
 Nylon
 Ford Ranger '80/
 UNIT PACKAGE 50



78-4803
 Replaces: D5LY-1A100A, D7TZ-1A100-A
GROMMET-USED ON ALUMINUM WHEELS
 Ford Products '75/
 Lincoln Mercury '75/
 UNIT PACKAGE 25



78-4824
GROMMET-WHEEL COVER RETAINING
 Ford Trucks '78/
 UNIT PACKAGE 50

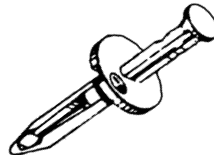

85-5945
 Replaces: N803709-S, 15681408, 4857108
RIVET-DRIVE TYPE, BUMPER, FASCIA & FENDER APRON
 Hole: M6.3, P.R.: 5 - 10MM, Flange: 15MM
 Plastic
 Ford '86/, G.M., Chrysler '97/ & Jeep 2005/
 UNIT PACKAGE 50

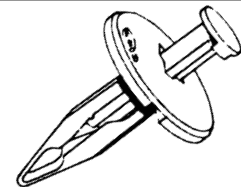

85-5944
 Replaces: 20570245, N803934-S, N804614-S
RIVET-DRIVE TYPE, BUMPER FASCIA
 Hole: M8, P.R.: 5 - 10MM, Flange: 25MM
 Plastic
 Ford Taurus, Sable '86/,
 G.M. Fiero; Tire Compartment '84/
 UNIT PACKAGE 25

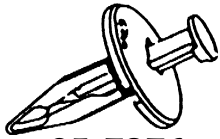
**95-7376**

Replaces: W701054-S300
RIVET-DRIVE TYPE, FRONT BUMPER, FENDER APRON
 Hole: M8, Head: 25MM
 P.R.: 5.8 - 8.7MM
 Black Plastic
 Ford Contour & Mercury Mystique '95/
 Cougar '99/, G.M. Colorado/
 Canyon S/T Truck 2004
UNIT PACKAGE 25

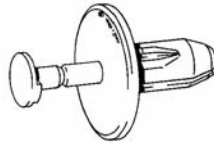
**98-7762**

Not Supplied By OEM
RIVET- DRIVE TYPE
 Front Bumper Air Deflector
 Plastic
 Hole: M8, Flange Dia: 25MM,
 Stem Lgth: 15MM, P.R.: 3.2-8.5MM
 Ford Van E350 '93/
UNIT PACKAGE 15

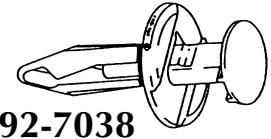
**92-7038**

Replaces: 5485676, 15691478,
 15969147, 21030249, N807389-S,
 W711035-S300, 6503598
RIVET-DRIVE TYPE FENDER APRON, BUMPERS & GRILLES
 Hole: M8, Flange: 20MM, P.R. 3-8MM
 Plastic
 G.M. Saturn '91/, G.M. C/K Truck '99/ &
 Hummer, Chrysler '95-2000, Ford 2006/
 Dodge Nitro 2007/ Jeep 2005/
UNIT PACKAGE 50

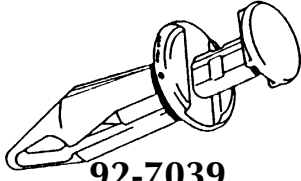
**92-7039**

Replaces: 11561878, 21075686,
 F3LY-14570-B
RIVET-DRIVE TYPE WHEELWELLS, FRONT BUMPER UPPER FASCIA, COWL
 Hole: M8, Flange: 15MM, P.R. 3-8MM
 Plastic
 G.M. Saturn '91/, Corvette '97/
 Grand Prix 2004 & Ford Explorer/Mtn. '95/
UNIT PACKAGE 50

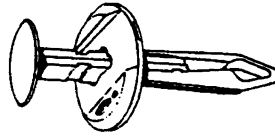
**98-7810**

Replaces: N803716-S
RIVET- PIN DRIVE TYPE
 Various Fascia Attachments
 Plastic, (Formerly 85-5951)
 Hole: M6, Flange: 17.5MM
 P.R.: 5-9MM, Ford Mustang '85/
UNIT PACKAGE 15

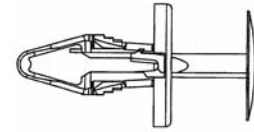
**99-8578**

Replaces: 11589290, W714040-S300
RIVET-DRIVE TYPE,
 COWL VENT & BUMPER, Plastic
 Hole: M6.25-6.53, Flange: 18MM,
 Stem Lgth: 20MM, P.R.: 4.5-7.0
 G.M. 'A' 'W', 'L', 'M', G5 Body 2005/
 C/K Truck & SUV 2007/, Saturn Sky
 2007/, Ford Flex 2009
UNIT PACKAGE 50

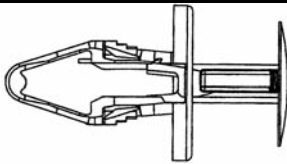
**99-8579**

Replaces: 11589293, W712196-S300
RIVET-DRIVE TYPE,
 COWL VENT, FENDER & BUMPER Plastic
 Hole: M8.25-8.53, Flange: 20MM,
 Stem Lgth: 21.5MM, P.R.: 4.5-7.0
 G.M. 'W', 'N' Body & Hummer 2005/
 Full Size SUV & Suburban 2007/
 Ford Edge/MKX 2007/, Flex 2009
 Fusion/MKZ/Zephyr/Milan2006/
UNIT PACKAGE 25

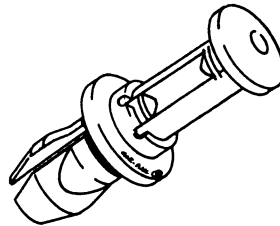
**99-7936**

Replaces: XL3Z-17E971-AA
RIVET-DRIVE TYPE,
 FRONT BUMPER
 Hole: M10.5, Flange: 12.5MM, PR: 3-4.6MM
 Plastic
 Ford "F" Pickup '99/
UNIT PACKAGE 25

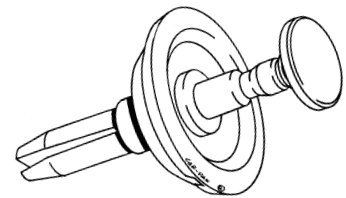
**98-7877**

Replaces: 4805405AA, 1L5Z-17K826-AA
RIVET-DRIVE TYPE, FRONT BUMPER
 Hole: M8.5, Flange: 34MM
 P.R.: .5-2.0MM, Shoulder: 3.5 x 11MM
 Chrysler Concord, Intrepid, 300M
 PT Cruiser '98/, Pacifica 2004,
 Ford Explorer
UNIT PACKAGE 15

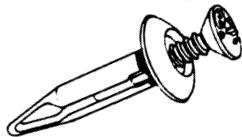
**85-5949**

Replaces: N803946-S, W706350-S300,
 W710752-SSC
RIVET-SCREW TYPE, VARIOUS EXTERNAL COMPONENTS
 Hole: M6.3, P.R.: 5 - 12MM, Flange: 15MM
 Plastic
 Ford '86/
UNIT PACKAGE 25

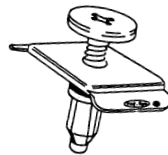
**96-7598**

Replaces: E8BZ-17C756-C
RIVET- SCREW TYPE
 Bumper Cover Retainer
 Plastic-Black
 Hole Dia: M8, Shoulder: 9.5MM
 G.R. 3-7MM
 Ford Festiva '88/, Mazda 323 '86/
UNIT PACKAGE 10

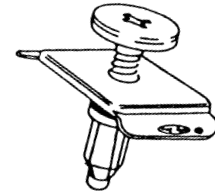
**90-6766**

Replaces: E7GZ-17A904-G & BF82-50-233
RIVET-SCREW TYPE FRONT & REAR BUMPER COVER
 Hole: M10, P.R.: 7-12MM
 Ford Escort, Mercury Tracer '87/
 Mazda 323 '87/
UNIT PACKAGE 10

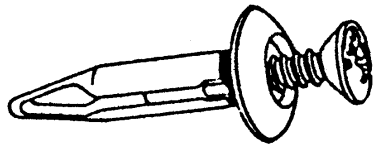
**86-6096**

Replaces: 10139822 N808147-S

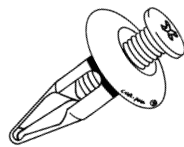
RIVET- SCREW TYPERear Bumper Fascia, Trunk Trim
Plastic-BlackHole Dia: M6.3, Stem Lgth: 18MM
Head Dia: 17.5MM, P.R.: 3-8MM
G.M. "J" & "N" Bodies '91/, Ford,
Lincoln T.C. '95/
UNIT PACKAGE 25**99-8146**

Replaces: W706713-S300

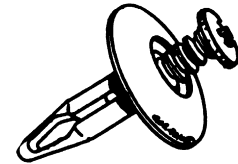
RIVET-SCREW TYPEFront Bumper Cover
PlasticHole: M8, Flange: 18MM,
P.R.: 2.4-9MM, Stem Lgth.: 18MM
Ford Escape 2001
UNIT PACKAGE 25**99-8039**

Replaces: YS4Z-16K262-AA

**RIVET-SCREW TYPE FENDER SPLASH
SHIELD, REAR BUMPER & RADIATOR
SHIELD**

Plastic

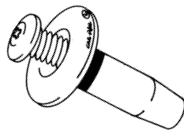
Hole: M6, Flange: 16MM, P.R.: 1.6-6MM
Stem Length: 17.5MM
Ford Focus 2000
UNIT PACKAGE 25**99-8140**

Replaces: W706494-S300

**RIVET-SCREW TYPE, CLOSED END
REAR BUMPER COVER**

Plastic

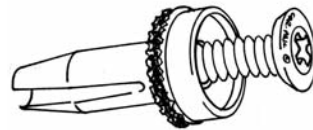
Hole: M8, Flange: 18MM, P.R.: 3.8 - 5MM,
Stem Length: 18MM
Ford Taurus/Sable Sedans 2000/
UNIT PACKAGE 25**99-8768**Replaces: W713202-S300,
W713445-S300**RIVET-SCREW TYPE, BUMPERS**

Plastic w/Seal

Hole: M8, Flange: 13MM,
Stem Lgth: 21MM, P.R.: 3.8-5.0MM
Ford Fusion 2006/
UNIT PACKAGE 15**99-8711**

Replaces: W710250-S300

RIVET-SCREW TYPE, REAR BUMPER

Plastic

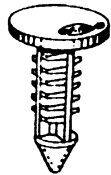
Hole: M8, Flange: 17.8MM,
Stem Lgth: 18MM, P.R.: 3.8-5.0MM
Ford Edge 2007/
UNIT PACKAGE 25**85-5950**

Replaces: N803170-S

**RETAINER-VARIOUS FASCIA
ATTACHMENTS**Hole: M5, Head: 10MM
PlasticFord Mustang, Capri '84/
UNIT PACKAGE 50**86-6061**

Replaces: N803857-S

**RETAINER-VARIOUS FRONT END FASCIA
ATTACHMENTS**Head Dia.: 15MM
Black PlasticFord, Mercury, Marquis, LTD '85/
Aerostar '85/
UNIT PACKAGE 50**98-7882**

Not Supplied By O.E.

**RETAINER- BUMPER COVER,
DOOR WEATHERSTRIP**

Plastic

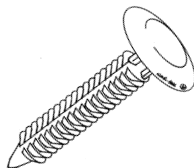
Hole: M5, Head: 13MM
P.R.: 1.5 - 12.5MMFord Contour & Mystique '95/
& Taurus/Sable
UNIT PACKAGE 50**99-8216**

Replaces: W701855-S300

**RETAINER-REAR BUMPERS, FENDER
FLARES & MUD FLAPS**

Plastic

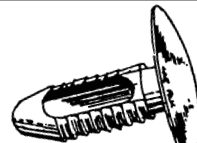
Hole: M6.3, Head: 22MM, O/L: 37MM
Ford Explorer/Mountaineer 2002, Focus
2000/
UNIT PACKAGE 25**85-5947**Replaces: 22718305,
N802734-S, N808679-S**RETAINER-FENDER APRON,
FRONT BUMPER, HOOD INSULATOR**

Plastic: Textured

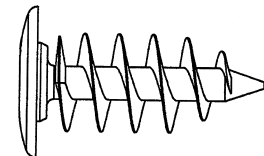
Hole: M7, Head: 25.4MM,
Stem Lgth.: 20MM, P.R.: 2-10MM
G.M. Cars & Trucks 2004/
Ford Mustang 2001/
UNIT PACKAGE 50**99-8656**

Not Supplied by O.E.

SCREW-BUMPER & DOOR INSULATORS

Plastic, Truss Head

Hole: M12, Head: 22MM, O/L: 36MM,
Thread Dia.: 14MM, Drive: #3 Square
G.M., Ford & Chrysler 2005/
UNIT PACKAGE 25

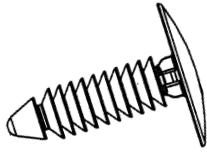
**99-8348**

Replaces: W708035-S300
RETAINER - REAR BUMPER COVER
 Plastic Use W/ 99-8349
 Hole: M6.3, Hd: 21MM,
 Stem Lgth: 25MM, O/L: 27.5MM,
 P.R.: 3-17MM
 Ford Expedition 2003/
 UNIT PACKAGE 25

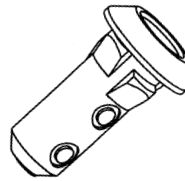
**99-8349**

Replaces: W708045-S300
GROMMET - REAR BUMPER COVER
 Rubber Use W/ 99-8348
 Hole: M9.5, Flange: 15MM,
 O/L: 25MM, P.R.: .80 & 1.8-2.25MM
 Ford Expedition 2003/
 UNIT PACKAGE 25

**99-8604**

Replaces: W711412-S300
GROMMET-REAR BUMPER
 Plastic
 Hole: M5.5-5.86sq.,
 Flange: 9.5MM sq.,
 O/L: 12.8MM, P.R.: 0.7-1.0MM,
 Screw: M4.2 (#8)
 Ford Fusion 2006
 UNIT PACKAGE 50

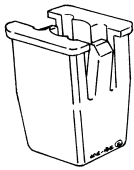
**99-8104**

Replaces: F5RZ-17K657-A
**GROMMET-WINDSHIELD WASHER
 RESERVOIR MOUNTING &
 FRONT BUMPER**
 Hole: M9.7, Flange: 12.7MM,
 P.R.: 1.5MM, Screw: M5.48 (#12)
 Ford Contour, Mystique '95/ & Focus 2000
 UNIT PACKAGE 25

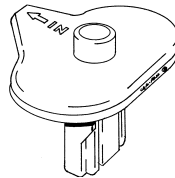
**99-8276**

Replaces: F7CZ-17C756-BA
**GROMMET - FRONT & REAR
 BUMPER COVER, Plastic**
 Hole: 8.9X14.7MM Oval,
 Screw: M5.48 (#12)
 Ford Escort/Tracer '97-2001
 UNIT PACKAGE 15

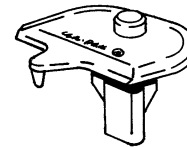
**99-8263**

Replaces: W707606-S300
GROMMET - REAR BUMPER COVER
 Plastic
 Hole: 7.2 x 12MM, Screw: M4.8
 Ford Escape 2001/
 UNIT PACKAGE 15

**99-8582**

Replaces: W707388-S300
RETAINER-FRONT BUMPER COVER
 Plastic-Black
 Hole 8x12MM, P.R.: 1.2-1.3MM
 Ford Escape 2001/
 UNIT PACKAGE 10

**99-8583**

Replaces: W705849-S300
RETAINER-REAR BUMPER COVER
 Plastic-White w/Seal
 Hole 8x12MM, P.R.: 0.7-0.8
 Ford Escape 2001/
 UNIT PACKAGE 10

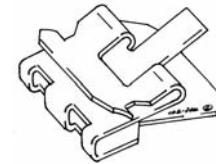
**99-8703**

Replaces: W701295-S301
CLIP-ENGINE SPLASH SHIELD
 Ford Focus 2000/
 UNIT PACKAGE 10

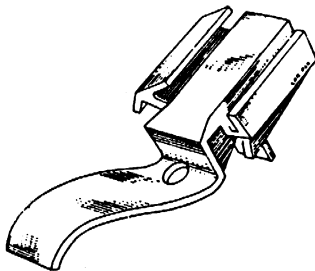
**77-4516**

Replaces: D7LZ-170817B
**CLIP-FRONT BUMPER STONE
 DEFLECTOR**
 Mark V '77/
 UNIT PACKAGE 50

**77-4550**

Replaces: 385996-S100
CLIP-BUMPERS
 Ford Products
 UNIT PACKAGE 100

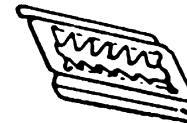
**93-7202**

Not Supplied By O.E.
RETAINER-FRONT BUMPER COVER
 Ford Festiva '88/
 UNIT PACKAGE 25

**99-8661**

Replaces: 14083173, 17988488,
17997722, 25536302, N803685-S
NUT-SNAP IN STYLE
Front Bumper, Side/High Stop Lamps,
Rear Wheel
Flare & Interior Trim/Dash Mountings
Screw: M4.2 (#8), Hole: 9x11MM
G.M., Saturn, Hummer, Ford & Jeep '82/
UNIT PACKAGE 25

**90-6829**

Replaces: 15686142, N802865
**NUT-GRILLE, BUMPER
& RADIATOR SUPPORT**
Screw M4.2
Black Finish
G.M. & Lincoln '83/
UNIT PACKAGE 25

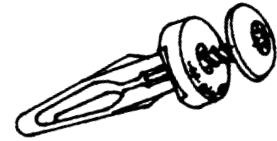
**89-6587**

Replaces: N805295-S, N805229-S,
22595587
**RIVET-SCREW TYPE, LICENSE PLATE
LAMP RET. COWL & VARIOUS TRIM
APPLICATIONS**
Hole: M5, P.R.: 4 - 8MM
Plastic
Ford '88/, G.M.
UNIT PACKAGE 25

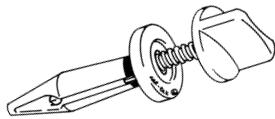
**97-7636**

Replaces: N808908-S
**RIVET-Headlamp Accessory
Thumb Screw Type**
Plastic
Hole Dia: M6.3, Head Dia: 14MM
Grip Range: 2.5-5.5MM
Stem Lgth: 23MM
Ford Mustang '96/
UNIT PACKAGE 10

**99-8318**

Replaces: W706182-S300
RIVET - SCREW TYPE
Headlamp Mounting
Plastic
Hole: M7.5, Flange: 20MM,
Stem Lgth: 13.5MM, Hex: 10MM
Ford Focus 2000/
UNIT PACKAGE 25

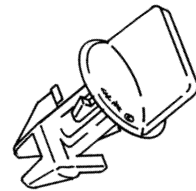
**98-7872**

Replaces: 25535963, N811772-S
**RETAINER-SIGHT SHIELD &
H/L SHROUD COVER**
Plastic - Twist Lock
G.M. "C", "H" & "N" Bodies '94 - '96
Ford Full Size & Lincoln T. Car '98/
UNIT PACKAGE 15

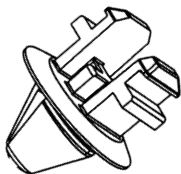
**99-8347**

Replaces: W708771-S300
**RETAINER - RADIATOR SHROUD AIR
DEFLECTOR & COWL VENT**
Plastic
Hole: 10 X 15MM Slot, O/L: 24MM,
P.R.: 1MM
Ford Expedition & Excursion 2003/
UNIT PACKAGE 50

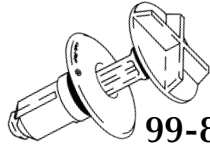
**99-8266**

Replaces: W705957-S300,
W706519-S300, 10382313
RIVET - DRIVE TYPE (TWIST TO RELEASE)
Radiator Sight Shield & Interior Trim
Plastic
Hole: M9, Shoulder: 3 X 10MM,
Flange: 25MM, Stem Lgth: 14MM
Ford, Lincoln & Mercury 2000/
Cadillac STS 2005/
Pontiac Solstice/Saturn Sky 2006/
UNIT PACKAGE 10

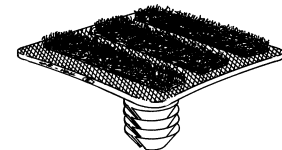
**97-7725**

Replaces: N811238-S
RETAINER-UPPER RADIATOR SHIELD
Plastic
w/Loop Side of Loop/Hook Fastener
Hole: M9, 50MM Square
Lincoln Continental '97/
UNIT PACKAGE 5

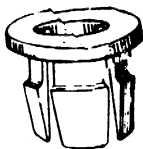
**95-7427**

Replaces: N807994-S, W704740-S300
**GROMMET-CORNERING
LAMP RETAINER**
Hole: M10, Flange: 13MM
Plastic
Ford Mustang '94
UNIT PACKAGE 25

**98-7909**

Replaces: N811169-S, W705550-S300,
90189-06111
**RETAINER-PARK & TURN SIGNAL
HOUSING, HEADLAMP MOUNTING**
Plastic, w/Aero Style Lamps
Hole: M10.5, Head: 13MM
Ford F250-F550 '99/, Toyota & Lexus '89/
UNIT PACKAGE 50

**97-7758**

Replaces: N807706-S
RETAINER-TAIL LAMP RETAINER
Plastic
Hole: M9.5
Ford F150, F250, Navigator &
Windstar '95/
UNIT PACKAGE 50

**90-6850****GROMMET-TAIL LIGHT MOUNTING**

Screw: #6

Plastic

Ford

UNIT PACKAGE 100

**93-7203**Replaces: 389360-S
GROMMET-TAIL LAMP ASSEMBLY

Screw: M4.2

Plastic

Various Ford & G.M. Applications '79/
UNIT PACKAGE 50**99-8238**Replaces: 25649667, W705590-S300,
W710459-S300
**GROMMET - BACKGLASS MOULDINGS,
DECK LID, LAMP MOUNTING,
LIFTGATE & INTERIOR TRIM PANEL**

Plastic w/seal

Hole: 9x18MM, Flange: 13x22MM,
P.R.: 0.9-1.3MM, Screw: M4.2 (#8)

Cadillac 'E' & 'K' Bodies '98/ &

Ford Windstar '99/

UNIT PACKAGE 15

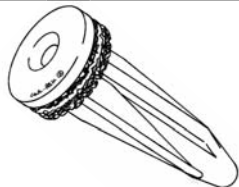
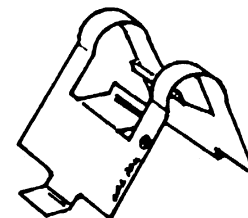
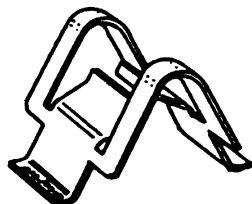
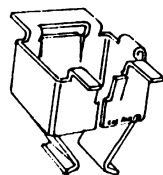
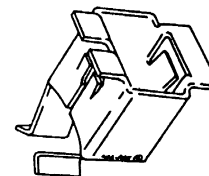
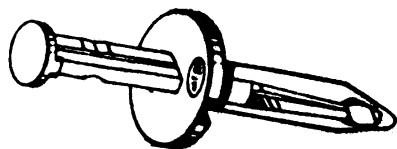
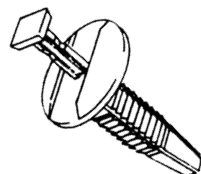
**99-8806**Replaces: W708319-S300
GROMMET-FRT. & RR BUMPER
Plastic-w/SealHole: M8sq., Flange: 16MM,
O/L: 25MM, P.R.: 2MM, Screw: M4.2 (#8)
Ford Fusion, Lincoln MKS, Zepher/MKZ,
Mercury Milan 2006/
UNIT PACKAGE 15**99-8779**Replaces: F5OY-14603-A
**GROMMET-HEADLAMP
& TAIL LAMP MOUNTING, Plastic**
Hole: 9.5x13.5MM,
Flange: 18.5x21.5MM, O/L: 19.6MM
Ford Explorer, Navigator
& SD Pick Up 2003/
UNIT PACKAGE 25**87-6205**Replaces: N803719-S
CLIP-PARKING LAMP RETAINING
Black Finish
Ford Escort Lynx '85/
UNIT PACKAGE 50**87-6332**Replaces: N802832-S32B
RETAINER-PARKING LAMP
Ford Tempo / Topaz '84/
UNIT PACKAGE 50**88-6518**Replaces: N804775-S32B
CLIP-PARKING LAMP RETAINING
Black Finish
Ford Escort & Lynx '88/
UNIT PACKAGE 25**92-7080**Replaces: N806624-S191
RETAINER-TAIL LAMP LENS
HOLDS LOCATING STUDS
Ford Explorer '91/
UNIT PACKAGE 25**84-5840**Replaces: N803362-S, 20510029
RIVET-DRIVE TYPE
LUGGAGE COMPARTMENT
Hole: M6, Flange: 18MM
Ford Escort/Lynx '84/
Pontiac Fiero '85/
UNIT PACKAGE 50**96-7560**Replaces: N808847-S, C2S13233
**RIVET-DRIVE TYPE, TRUNK TRIM
& COWL VENT**
Hole: M6.3, Head: 25MM
P.R.: 4-8MM
Black Plastic
Ford Taurus, Sable '96/, Jaguar X Type 2002/
UNIT PACKAGE 25**95-7474**Replaces: 21036860, 25612368 &
N807673-S
RIVET-DRIVE TYPE
DASH & TAILGATE
Hole: M7, Head: 14MM
Black Plastic
Saturn '95/ & Ford 'F' Trucks '97/
UNIT PACKAGE 15



95-7370

Replaces: W701380-SSW
RETAINER-TRUNK LINER
 Hole: M6.3, Head: 18MM
 Stem Length: 21MM
 Black Plastic Paint to Match
 Ford Contour & Mercury Mystique '95/
UNIT PACKAGE 15

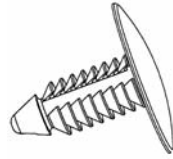

99-8804

Replaces: W706815-S300, 6508727AA
RETAINER-TRUNK TRIM & INSULATOR
 Plastic-Textured
 Hole: M6.7, Head: 23MM, Stem Legth:
 20MM, O/L: 22.5MM P.R.: 2.7-7.5MM
 Ford Focus, Fusion, Lincoln MKS,
 Zepher/MKZ, Mercury Milan 2006/
 Chrysler
UNIT PACKAGE 25

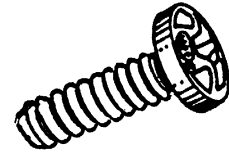

84-5821

Replaces:385324-S103
SCREW-PHILIPS PAN HEAD
 8-32 x 3/8" Stainless '73/
UNIT PACKAGE 50

BELT REVEAL AND VINYL TOP MOULDING



74-3972

Replaces: 6003147
CLIP-BELT & LOWER SIDE MOULDING
 Chrysler Products '72 - '74
UNIT PACKAGE 100

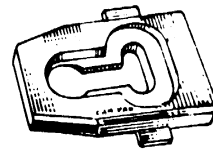

75-4107

Replaces: 6003577
CLIP-ROOF TRANSVERSE QUARTER
OUTIDE BELT & DECK LID,
REAR MOULDING
 Chrysler Products '75/
UNIT PACKAGE 100



77-4513

Replaces: 6003653
CLIP-ROOF SIDE MOULDING
 Chrysler Products '77/
UNIT PACKAGE 50

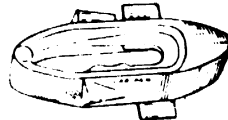

77-4517

Replaces: 6003609
CLIP-ROOF SIDE MOULDING
 Chrysler Products '77/
UNIT PACKAGE 100



77-4512

Replaces: 6003648
CLIP-QUARTER OUTSIDE BELT
MOULDING
 Chrysler Products '77/
UNIT PACKAGE 50

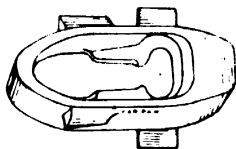

77-4518

Replaces: 6003661
CLIP-ROOF OUTSIDE TRANSVERSE
MOULDING
 Chrysler Products '77
UNIT PACKAGE 100

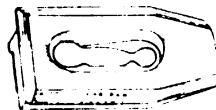

77-4514

Replaces: 6003647
CLIP-QUARTER OUTSIDE BELT
MOULDING
 Chrysler Products '77/
UNIT PACKAGE 50

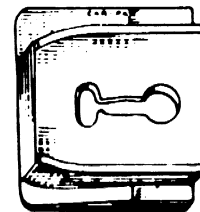

76-4355

Replaces: 6003625
CLIP-ROOF TRANSVERSE MOULDING,
UPPER
 Chrysler Products '77/
UNIT PACKAGE 50

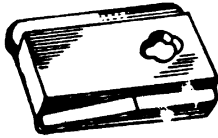

76-4360

Replaces: 6003613
**CLIP-ROOF OUTSIDE TRANSVERSE
 MOULDING**
 Chrysler Products '77/
UNIT PACKAGE 50

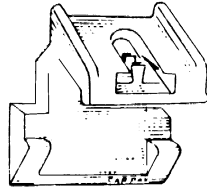

79-5093

Replaces: 6003744
CLIP-REAR GLASS, LOWER MOULDING
 Chrysler Products '80/
UNIT PACKAGE 25

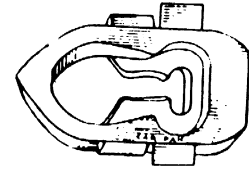

79-5068

Replaces: 6003713
CLIP-VINYL ROOF MOULDING
 Chrysler Products '80/
UNIT PACKAGE 50



81-5451

Replaces: 6003817
CLIP-ROOF TRANSVERSE MOULDING
 Chrysler Products '82/
UNIT PACKAGE 25

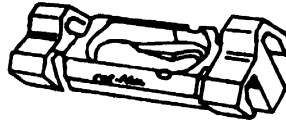

88-6439

Replaces: 6004006
**CLIP-MOULDING UPPER BACK PANEL
 PADDED VINYL ROOF**
 Chrysler Lebaron 4 Door '87/
UNIT PACKAGE 15

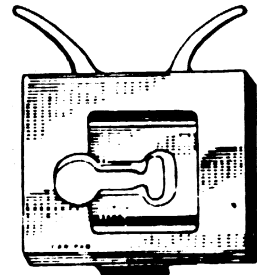

76-4350

Replaces: 6003566
CLIP-ROOF TRANSVERSE MOULDING
 Chrysler Products
UNIT PACKAGE 50

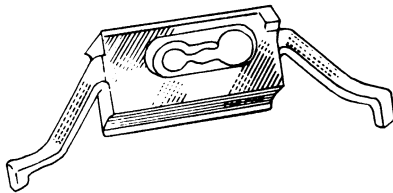

78-4868

Replaces: 6003688
**CLIP-VINYL ROOF TRIM OFF
 MOULDING**
 Chrysler Products '79/
UNIT PACKAGE 100

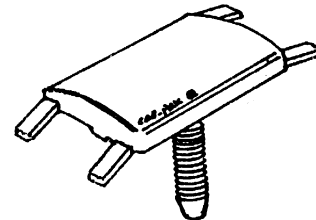

85-5994

**CLIP-ROOF MOULDING
 LANDAU TOP**
 Plastic
 Chrysler "E" Bodies '82/
UNIT PACKAGE 50

FENDER & WHEEL OPENINGS

78-4873

Replaces: 6003696
**CLIP-FRONT FENDER
 LOWER MOULDING**
 Chrysler Products '79/
UNIT PACKAGE 25

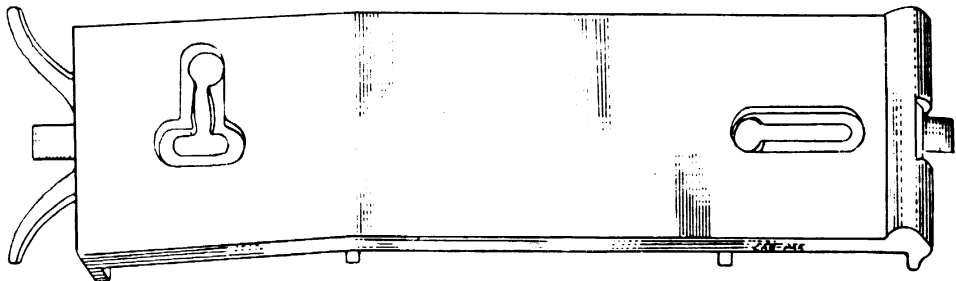

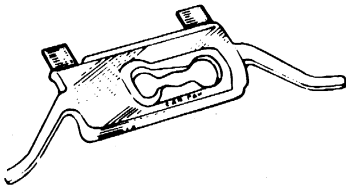
**88-6550**

Replaces: 6003632
CLIP-FENDER WHEEL HOUSE
 MOULDING
 Plastic
 Chrysler Products '77/
UNIT PACKAGE 50

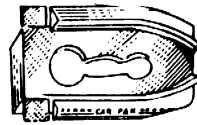
**78-4867**

Replaces: 6003682
CLIP-WHEEL SURROUND MOULDING
 Chrysler Products '78/
UNIT PACKAGE 50

**94-7255**

Replaces: 6016271
RIVET-DRIVE TYPE, FRONT
 WHEEL WELL
 Hole: M5, Head: 9MM, P.R.: 2-3MM
 Plastic
 Dodge Ram Full Size Pick-up '94/
UNIT PACKAGE 25

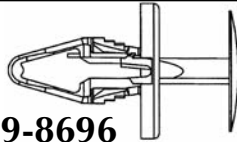
**99-8696**

Replaces: 11589289, W713610-S300,
 6508863AA
RIVET-DRIVE TYPE, Flares, Cowl,
 RKR Moulding., Front Bumper, Plastic
 Hole: M6.25-6.53, Flange: 18MM,
 Stem Lgth: 17.5MM, P.R.: 2-4MM
 G.M. Equinox & Torrent 2007,
 Buick Enclave, Saturn '91/
 Ford Focus 2008/ & Dodge PU 2009/
UNIT PACKAGE 25

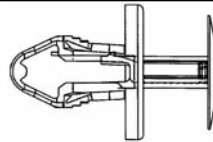
**99-8697**

Replaces: 15296830, 5116530AA
RIVET-DRIVE TYPE,
 FLARES & PANELS
 Plastic
 Hole: M7.75-8.25, Flange: 19MM,
 Stem Lgth: 16MM, P.R.: 5-7MM
 G.M. & Dodge Caliber & Charger, Jeep
 Patriot 2006/
UNIT PACKAGE 25

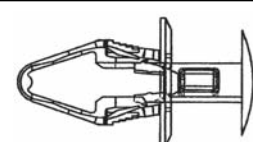
**99-8580**

Replaces: 11561368, 6508712AA
RIVET-DRIVE TYPE, FENDER,
 WHEEL & BUMPER
 Plastic
 Hole: M9.25-9.53, Flange: 18MM,
 Stem Lgth: 20MM, P.R.: 3.0-5.7MM
 G.M. 'W' & 'M' Body 2006,
 Jeep Wrangler 2006/
UNIT PACKAGE 25

**76-4347**

Replaces: 6003617
NUT-FENDER SIDE FRONT MOULDING
 Chrysler Products
UNIT PACKAGE 100

**97-7722**

Replaces: MB361578
GROMMET-FENDER MOULDING
 Plastic-W/Sealer
 Hole: 8 X 11MM, Face: 17MM Sq, Use
 M4.2 Screw
 Chrysler & Mitsubishi '97/
UNIT PACKAGE 10

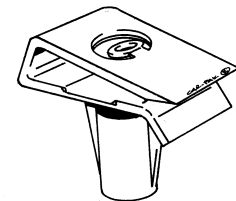
**99-7923**

Replaces: 6504870AA
U-NUT-FENDER
 M4.2 Tapping Screw, P.R.: 1-4.25MM
 Plastic
 Chrysler LH, 300M '98/
UNIT PACKAGE 25

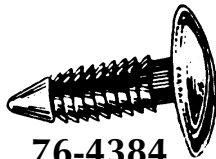
**76-4384**

Replaces: 1605396, 15958694, 6030441,
 6502078, 388577-S, 6036007AA
RETAINER-PLASTIC SHIELD, FENDERS
 AND ENGINE COMPARTMENT
 G.M. Cars '76/, Chrysler Products '76/
 Ford Products '76/, Jeep Liberty 2002
UNIT PACKAGE 100
J05546
UNIT PACKAGE 50

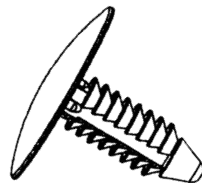
**99-8410**

Replaces: 6506293AA
RETAINER-FENDER APRON,
 HOOD INSULATOR, Plastic
 Hole: M6.35, Head: 25.4MM,
 O/L: 23.4MM P.R.: 2-10MM
 Chrysler 2005/ & Jeep Gr. Cherokee '99/
UNIT PACKAGE 50

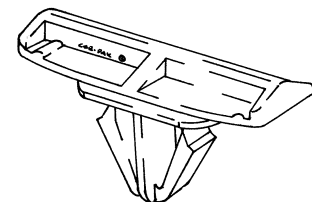
**99-8287**

Replaces: 55156447AB
RETAINER - FENDER FLARE
 Plastic
 Hole: M10
 Jeep Liberty 2002-2007
UNIT PACKAGE 10

**99-8566**

Replaces: 55157055AA, 55157065AA

RETAINER-FENDER FLARES

Plastic w/Seal

Hole: M9, Top Head: 14x38MM,

Stem Lgth: 15MM, P.R.: 0.75MM

Jeep Liberty 2005

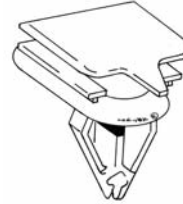
UNIT PACKAGE 15**99-8650**

Not Supplied by O.E.

RETAINER-FENDER & WHEEL FLARE

Plastic

Hole: M9, O/L: 20MM

Jeep Commander 2006/

UNIT PACKAGE 25**99-8760**

Replaces: 5189180AA

RETAINER-Front Fender Flare (Front)

Plastic

Head: 13x31MM, O/L: 29MM

Jeep Commander 2006/

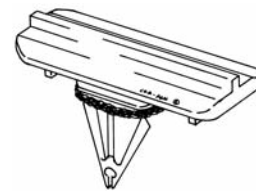
UNIT PACKAGE 15**99-8759**

Replaces: 5189181AA

RETAINER-Front Fender Flare (Rear)

Plastic w/Seal

Hole: M9-10,

Head:L 14x39MM, O/L: 22MM

Jeep Commander 2006/

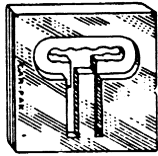
*UNIT PACKAGE 10***DOOR / QUARTER / ROCKER / DECK MOULDINGS****73-3926**

Replaces: 6003308

**CLIP-BODY SIDE MOULDING
ADJUSTABLE TYPE**

Chrysler Products '69 - '73

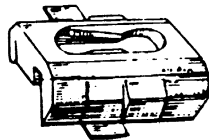
*UNIT PACKAGE 50***J04669***UNIT PACKAGE 100***77-4704**

Replaces: 6003300

CLIP-TAIL GATE UPPER MOULDING

Chrysler Products '69/

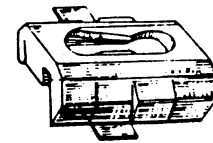
UNIT PACKAGE 50**76-4429**

Replaces: 6003334

**CLIP-STATION WAGON TAIL
GATE MOULDING**

Chrysler Products '69/

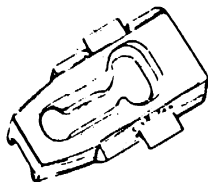
UNIT PACKAGE 100**77-4731**

Replaces: 6003132

CLIP-BODY SIDE MOULDING

Chrysler Products '70/

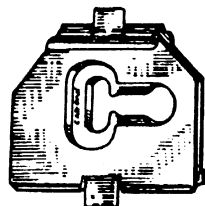
UNIT PACKAGE 50**75-4101**

Replaces: 6003201

CLIP-BODY SILL MOULDING

Chrysler Products '70 - '75

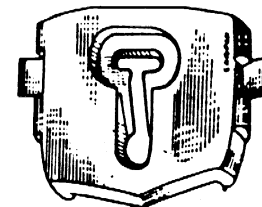
UNIT PACKAGE 100**75-4234**

Replaces: 6003248

CLIP-TAILGATE MOULDING

Chrysler Products Station Wagon '70 - '76

UNIT PACKAGE 50

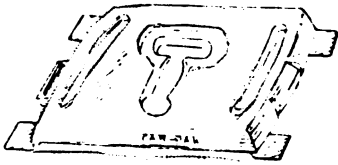

81-5290

Replaces: 6003486
CLIP-FENDER & DOOR MOULDING
 Chrysler Products '75 - '80
UNIT PACKAGE 100

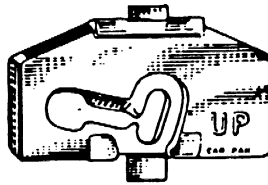

76-4246

Replaces: 6003164
CLIP-BODY MOULDING
 Chrysler Products
UNIT PACKAGE 100

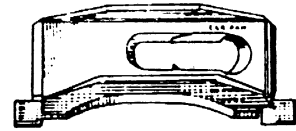

75-4183

Replaces: 6003592
CLIP-UPPER DOOR MOULDING, REAR
 Chrysler Products '76
UNIT PACKAGE 50

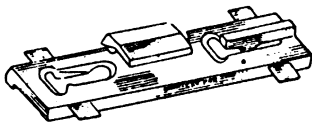

77-4637

Replaces: 6003669
CLIP-REAR DOOR OUTSIDE REAR MOULDING
 Chrysler Products '78/
UNIT PACKAGE 25

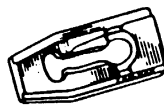

77-4575

Replaces: 6003653
CLIP-FRONT DOOR OUTSIDE BELT MOULDING, REAR
 Chrysler Products '78/
UNIT PACKAGE 50

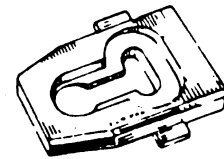

77-4603

Replaces: 4084368
CLIP-SIDE PANEL UPPER MOULDING
 Chrysler Products '78/
UNIT PACKAGE 100

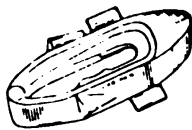

77-4638

Replaces: 6003677
CLIP-BODY SIDE SILL MOULDING
 Chrysler Products '78/
UNIT PACKAGE 25

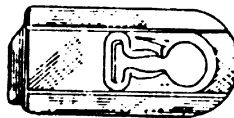

78-4887

Replaces: 6003707
CLIP-MOULDING
 Chrysler Products '79/
UNIT PACKAGE 50



79-5088

Replaces: 6003737
CLIP-QUARTER PANEL MOULDING
 Chrysler Products '80/
UNIT PACKAGE 50

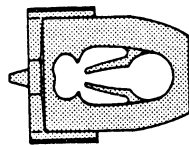

J02266

Replaces: 6002200
CLIP-BODY SIDE MOULDING
 Plastic
 Chrysler & General Purpose
UNIT PACKAGE 100

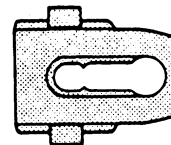

J04670

Replaces: 6003183
CLIP-BODY SIDE MOULDING
 Plastic
 Chrysler & General Purpose
UNIT PACKAGE 50

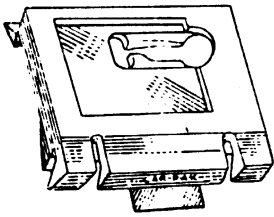
**80-5261**

Replaces: 6003774
CLIP-BODY SIDE MOULDING
 Chrysler Products '81/
UNIT PACKAGE 50

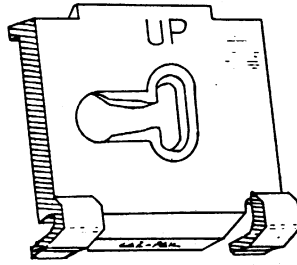
**83-5720**

Replaces: 6003861
CLIP-DECK LID MOULDING
 Chrysler & Dodge '84
UNIT PACKAGE 25

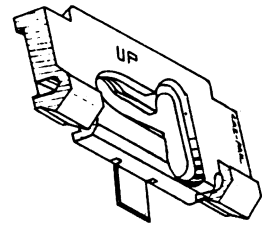
**83-5718**

Replaces: 6003858
CLIP-DECK MOULDING
 Dodge Van '84
UNIT PACKAGE 25

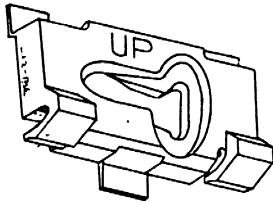
**83-5719**

Replaces: 6003856
CLIP-DECK LID MOULDING
 Dodge Van '84
UNIT PACKAGE 25

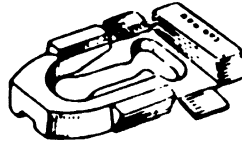
**89-6591**

CLIP-BODY SIDE MOULDING
 Dodge, Plymouth Trucks P/U
UNIT PACKAGE 50

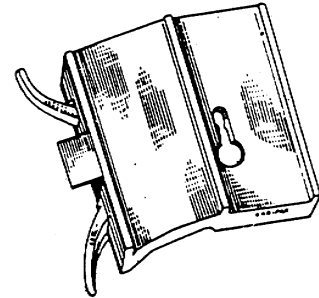
**75-4235**

Replaces: 6003331
CLIP-BODY SIDE MOULDING
 Chrysler Products '70 - '76
UNIT PACKAGE 50

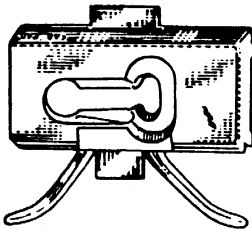
**74-3977**

Replaces: 6003219
CLIP-WIDE BODY SIDE MOULDING
 Used w/74-3978, Plastic
 Chrysler Cars & Trucks '71/
UNIT PACKAGE 100

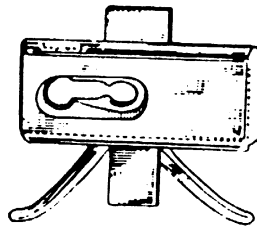
**74-3978**

Replaces: 6002927
CLIP-BODY SIDE MOULDING
 (Sometimes Used in Tandem with
 74-3977 on Wide Moulding)
 Chrysler Cars & Trucks '71/
UNIT PACKAGE 100

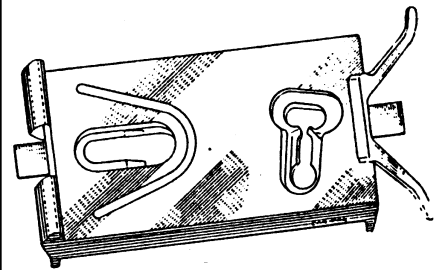
**78-4894**

Replaces: 6003638
CLIP-EXTERIOR MOULDING
 Chrysler Products '78/
UNIT PACKAGE 25

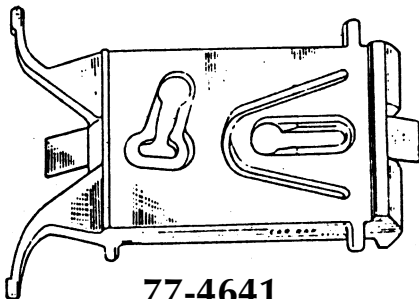
**77-4641**

Replaces: 6003685
**CLIP-QUARTER PANEL OUTSIDE
 MOULDING**
 Chrysler Products '78/
UNIT PACKAGE 25

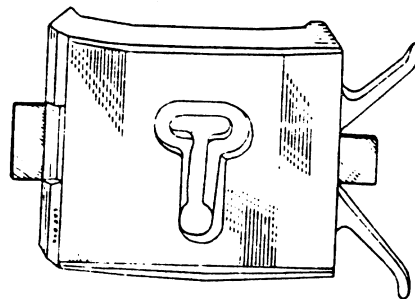
**79-5013**

Replaces: 6003634
CLIP-SILL MOULDING
 Omni & Horizon '78/
UNIT PACKAGE 25

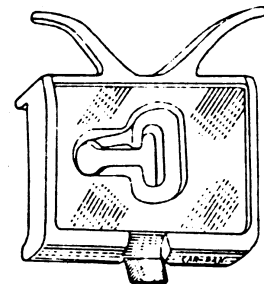
**80-5148**

Replaces: 6003684
CLIP-DOOR MOULDING
 Chrysler Products '78/
UNIT PACKAGE 50

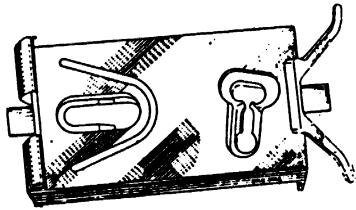

79-5078
 Replaces: 6003725
CLIP-REAR DOOR LOWER MOULDING
 Chrysler Products '80/
UNIT PACKAGE 25

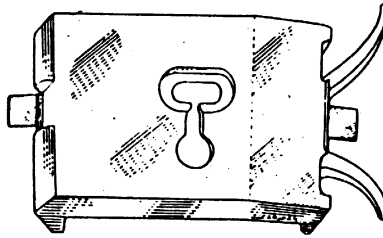

79-5076
 Replaces: 6003719
CLIP-REAR DOOR LOWER MOULDING
 Chrysler Products '80/
UNIT PACKAGE 25

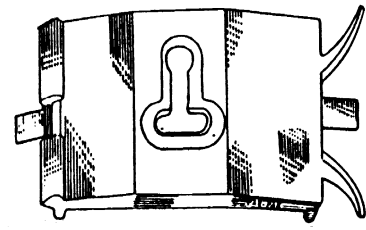

79-5069
 Replaces: 6003715
CLIP-SILL MOULDING
 Chrysler Products '80/
UNIT PACKAGE 50

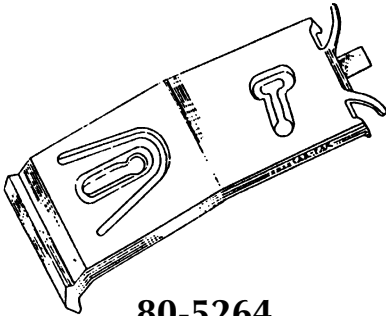

80-5264
 Replaces: 6003777
CLIP-SILL MOULDING
 Chrysler Products '81/
UNIT PACKAGE 25

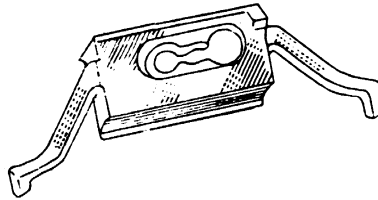

83-5721
 Replaces: 6003873
CLIP-BODY SIDE & BACK DOOR MOULDING
 Dodge Van '84
UNIT PACKAGE 25

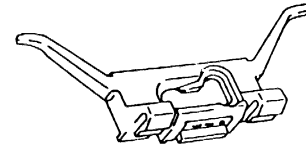

92-7029
 Replaces: 6004162
CLIP-FRONT DOORS & OUTSIDE UPPER MOULDING
 Plastic
 Chrysler Mini Van '89/
UNIT PACKAGE 25

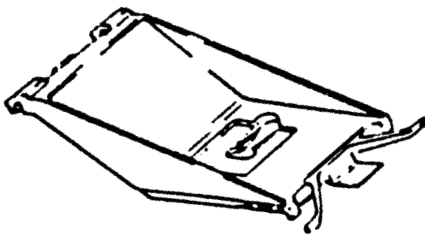

90-6816
 Replaces: 6003855
CLIP-SIDE MOULDING WOOD GRAIN
 Plastic
 Chrysler Minivans '84/
UNIT PACKAGE 10

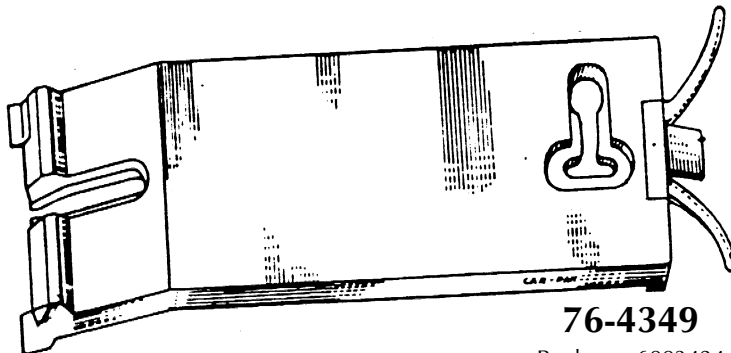

76-4349
 Replaces: 6003424
CLIP-BODY SIDE MOULDING
 Chrysler Products
UNIT PACKAGE 50

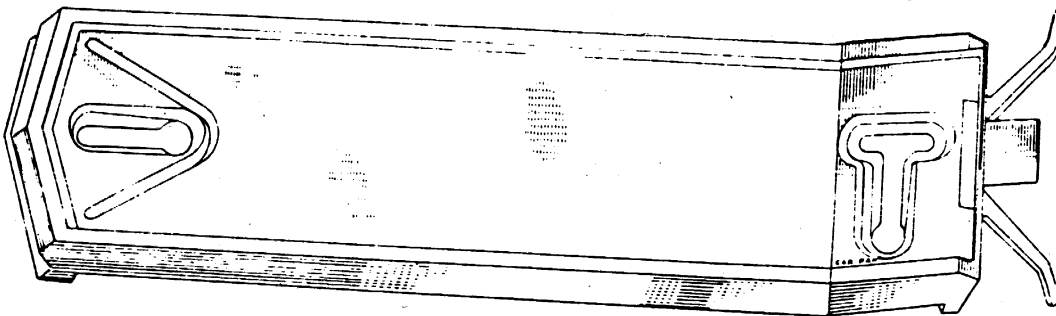

76-4416
 Replaces: 3810189
CLIP-SILL MOULDING
 Chrysler Products
UNIT PACKAGE 50

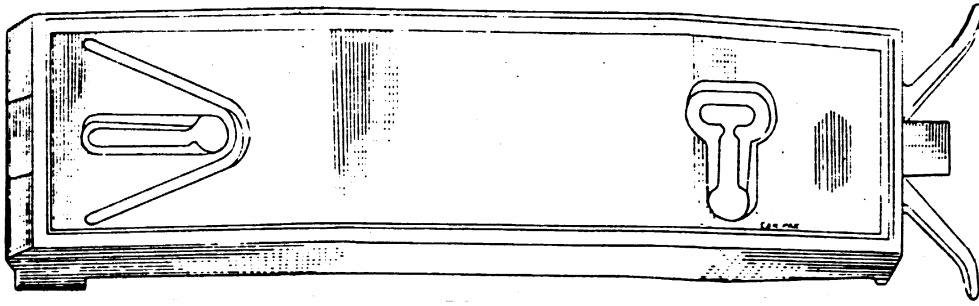

76-4417

Replaces: 381090
CLIP-SILL MOULDING
 Chrysler Products
 UNIT PACKAGE 50

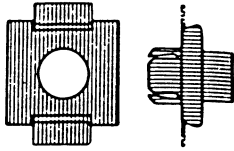

J04311

Replaces: 6001428
CLIP-SILL MOULDING
 Drive Type
 Plastic
 Chrysler & General Purpose
 UNIT PACKAGE 50

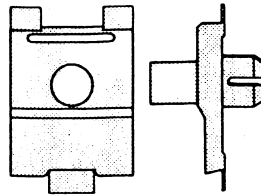

J04300

Replaces: 6001482
CLIP-BODY SIDE MOULDING
 Drive Type
 Plastic
 Chrysler & General Purpose
 UNIT PACKAGE 50

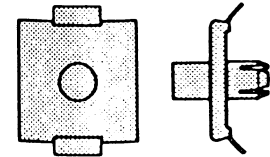

J04301

Replaces: 6001943
CLIP-BODY SIDE MOULDING
 Drive Type
 Plastic
 G.M. & General Purpose
 UNIT PACKAGE 50



93-7197

Replaces: 6503106
RIVET-DRIVE TYPE, LOWER REAR MOULDING
 Hole: M6.3, Head: 22MM
 Plastic
 Chrysler "LH" Models '93/
 Jeep Grand Cherokee, Larado '94/
 UNIT PACKAGE 15

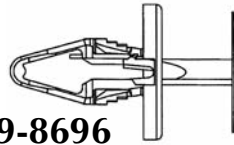

99-8696

Replaces: 11589289, W713610-S300,
 6508863AA
RIVET-DRIVE TYPE, Flares, Cowl, RKR Moulding., Front Bumper, Plastic
 Hole: M6.25-6.53, Flange: 18MM,
 Stem Lgth: 17.5MM, P.R.: 2-4MM
 G.M. Equinox & Torrent 2007,
 Buick Enclave, Saturn '91/
 Ford Focus 2008/ & Dodge PU 2009/
 UNIT PACKAGE 25

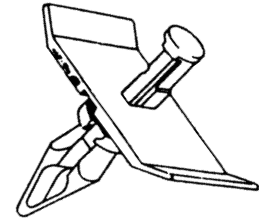

93-7144

Replaces: 4630253
RIVET-DRIVE TYPE, REAR FASCIA
 Hole: M10, Shoulder: 13MM x 5MM
 Flange: 45MM x 22MM
 Plastic
 Chrysler "LH" Cars '93/
 UNIT PACKAGE 15

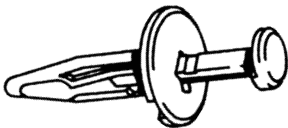

93-7145

Replaces: 10134407, 15990756,
 F50C-9E728-AA, 6501925
RIVET-DRIVE TYPE, BUMPER, ROCKER MOULDING
 Hole: M6.3, Flange: 17MM
 P.R.: 1.52MM - 7.62MM
 Chrysler "LH" '93/, Dodge Nitro 2007/, Jeep
 Liberty 2002, Dodge Journey 2009
 Ford & G.M., Hummer H2
 UNIT PACKAGE 25

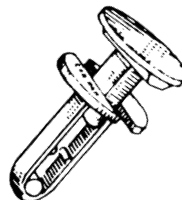

75-4126

RIVET-DRIVE TYPE
 Hole: 1/4"
 Plastic
 Chrysler
 UNIT PACKAGE 50



84-5839

Replaces: 6501067
RETAINER-LOWER BODY SIDE MOULDING, FASCIA COMPONENTS AIR DAM & GENERAL USAGE
 Plastic
 Grand Cherokee '93
 Chrysler "K", "LH", Omni & Viper '84/
 UNIT PACKAGE 50

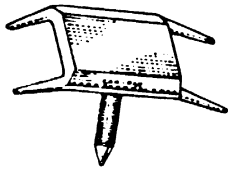

76-4368

Replaces: 6003629
RETAINER-BODY SIDE MOULDING
 Chrysler Products '77/
UNIT PACKAGE 50

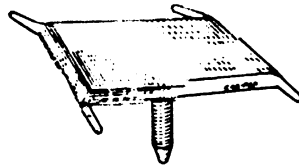

76-4367

Replaces: 6003630
RETAINER-BODY SIDE MOULDING
 Chrysler Products '77/
UNIT PACKAGE 50

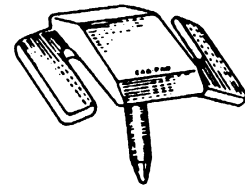

76-4353

Replaces: 6003616
RETAINER-SIDE PANEL UPPER MOULDING
 Chrysler Products '77/
UNIT PACKAGE 50

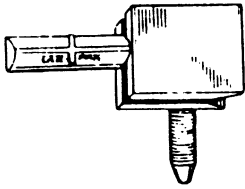

77-4600

Replaces: 6003681
RETAINER-QUARTER MOULDING OUTSIDE APPLIQUE
 Chrysler '78/
UNIT PACKAGE 50

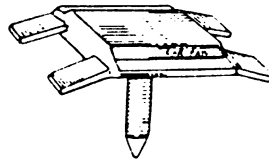

79-5097

Replaces: 6003734
RETAINER-MOULDING
 Chrysler Products '78/
UNIT PACKAGE 25

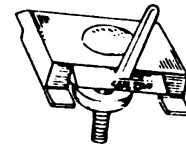

77-4577

Replaces: 6003659
RETAINER-DECK LID MOULDING
 Chrysler Products '78/
UNIT PACKAGE 10

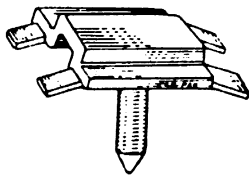

79-5082

Replaces: 6003730
RETAINER-MOULDING
 Chrysler Products '80/
UNIT PACKAGE 25

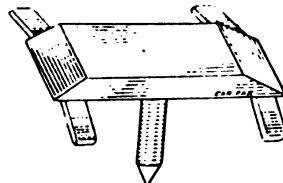

79-5107

Replaces: 6003738
RETAINER-MOULDING
 Chrysler Products '80/
UNIT PACKAGE 25

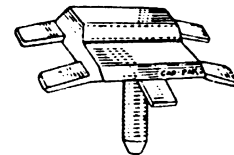

79-5092

Replaces: 6003745
RETAINER-DECK TRIM MOULDING
 Chrysler Products '80/
UNIT PACKAGE 25

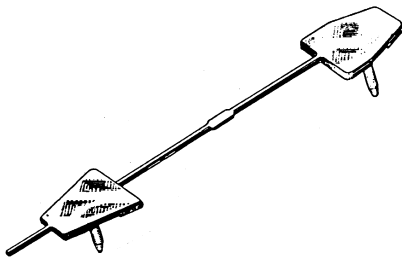

77-4509

Replaces: 6003665
RETAINER-BODY SIDE MOULDING
 Chrysler Products '77/
UNIT PACKAGE 50

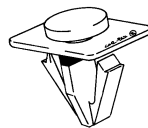

97-7726

CLIP- REAR QUARTER PANEL MOULDING
 Plastic
 Hole Dia: M10, Head Dia: 13MM
 Slot: 2 x 7.5MM
 Chrysler Minivan '96/
UNIT PACKAGE 50

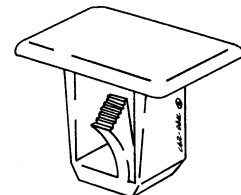

99-8024

Replaces: 5FR56DX9
RETAINER-ROCKER MOULDING
 Plastic
 Hole: M11 Sq., Head: 11 x 20MM
 Jeep Gr. Cherokee '99/
UNIT PACKAGE 15

**99-8514**

Replaces: 1BA41AX1AA
RETAINER-ROCKER MOULDING
 Plastic-Textured
 Hole: 9x31MM Slot, Head: 12x20MM,
 Stem Lgth: 13.1MM
 Chrysler 300 & Dodge Magnum 2005
UNIT PACKAGE 15

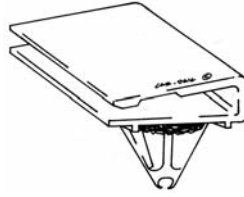
**99-8783**

Replaces: 6509288AA
RETAINER-ROCKER MOULDING
 Plastic-Black w/Seal
 Hole/Slot: M7
 Chrysler Grand Caravan &
 Town & Country 2008/
UNIT PACKAGE 10

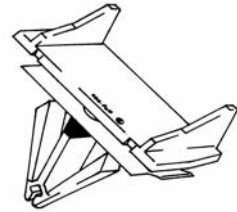
**99-8568**

Replaces: 55157069AB
RETAINER-ROCKER MOULDING
 Plastic
 Hole: M9
 Jeep Liberty 2002/
UNIT PACKAGE 25

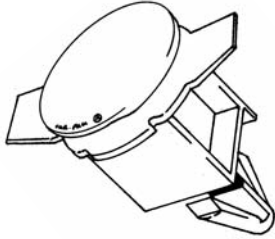
**99-8569**

Replaces: 55157070AC
RETAINER-ROCKER MOULDING
 Plastic
 Hole: M7
 Jeep Liberty 2002/
UNIT PACKAGE 10

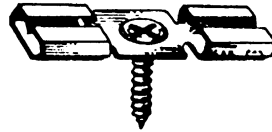
**72-3731**

Replaces: 6003350
**CLIP-FRONT DOOR INSIDE
 PANEL MOULDING**
 Dodge Truck '72 - '73
UNIT PACKAGE 50

**99-8205**

Replaces: 6002056
CLIP-T-BOLT TYPE W/SEALER
 Formerly 77-4533
 Bolt: 10-24 x 3/4", Plate: 5/16 x 3/4"
 Chrysler Products & General Purpose
UNIT PACKAGE 15

**J02255**

Replaces: 6000955
CLIP-MOULDING & MEDALLION
 Chrysler
UNIT PACKAGE 100

**89-6685**

Replaces: 4198993
CLIP-DOOR OPENING MOULDING
 Chrysler Mini Vans '88/
UNIT PACKAGE 50

**98-7782**

Replaces: 6000258
NUT-TUBULAR TYPE
 Side Window Moulding Trim
 Stud Dia: 1/4", Hole Dia: 5/16",
 Grip Range: .030-.034
 Chrysler Cirrus, Stratus, Breeze 97/
UNIT PACKAGE 50

**87-6250**

GROMMET-VARIOUS APPLICATIONS
 Screw: M6, Hole: M9, P.R.: 3.0 - 4.0MM,
 Flange: 15MM
 Black Plastic
 Ford, Chrysler
UNIT PACKAGE 25

**90-6756**

Replaces: 6033184
**GROMMET-FRONT & REAR DOOR
 CHANNEL ATTACHING**
 Hole: M6 sq., Screw No. 8
 Chrysler '88/
UNIT PACKAGE 50

**98-7907**

Replaces 6036042AA
**CLIP-DOOR WINDOW MOULDING,
 BRAKE STOP LAMP MOUNTING**
 Screw: #8 (M4.2), Slot: 3 x 14MM,
 P.R.: 1.14MM
 Chrysler LH, LHS '98/ &
 Jeep Cherokee 2000/
 Zinc Dacromate Finish
UNIT PACKAGE 25

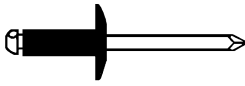

93-7148

Replaces: 15622490, 6032856
BLIND RIVET-SEALING TYPE, GROUND EFFECTS, BUMPER & GENERAL PURPOSE
 1/8" Rivet w/3/8" Flange
 G.R.: .125 - .375
 Black Aluminum Rivet w/ Stainless Steel Mandrel
 G.M. '97/Chrysler
 UNIT PACKAGE 25

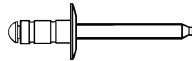

98-7801

Replaces: 6034848
RIVET-BLIND TYPE, MULTI GRIP STYLE
 Rocker Panel & Cladding Bracket
 1/8" Rivet, 5/16 Flange, .031-.187 G.R.
 Aluminum Rivet, Steel Mandrel
 Chrysler "LH" Cars '93-'97
 UNIT PACKAGE 50

WHITE MANDREL



93-7198

Replaces: 4630660
BLIND RIVET-COUNTERSUNK SUPER TOUGH NYLON BLACK, EXTERIOR MOULDINGS
 Hole: M6.3, Head: 17MM, G.R.: .7-4.9MM, Shoulder: 9MM x 2MM
 Chrysler "LH" Models '93-'97
 UNIT PACKAGE 15

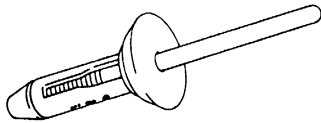

93-7104

Replaces: 4630088
BLIND RIVET-COUNTERSUNK HEAD SUPER TOUGH NYLON BLACK, EXTERIOR MOULDINGS BODY SIDE MOULDING ATTACHMENT
 Hole: M6.3, Flange: 17MM, G.R.: .7-4.5MM, Shoulder: 2.0MM
 Dodge & Eagle "LH" Models '93-'97
 UNIT PACKAGE 25

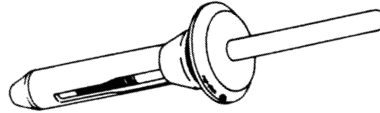

93-7200

Replaces: 6501509
BLIND RIVET-w/SHOULDER SUPER TOUGH NYLON BLACK, BODY SIDE MOULDINGS
 Hole: M6.3, Head: 17MM, G.R.: 1.0 - 5.0MM, Countersunk Shoulder: 4.5MM
 Chrysler "LH" Cars '93/ Various Models '87/
 UNIT PACKAGE 25

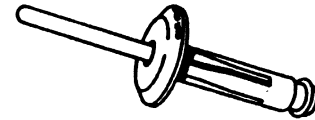

94-7288

Replaces: 6502689
BLIND RIVET-SUPER TOUGH NYLON BLACK GROUND EFFECTS
 Hole: M5,3/16", Head: 9MM, 11/32" G.R.: 4.5MM - 6MM, 5/32" - 1/4"
 Dodge Daytona
 UNIT PACKAGE 25

GARNISH/HEADLINER/INTERIOR

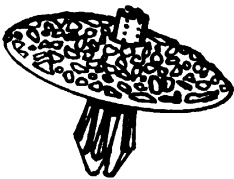

89-6636

Replaces: H452EK1
RETAINER-HEADLINER
 Tan Plastic Paint to Match
 Chrysler "M" Van '84/
 UNIT PACKAGE 10



98-7807

Replaces: 5208743, 4006529
CLIP-TRIM PANEL, HEADLINER
 Plastic-Textured Head
 Hole: 3/16", Head: 3/4" P.R.: 3/32-13/32"
 Formerly 86-6143
 Chrysler & AMC '84 / '88
 UNIT PACKAGE 50



99-7995

Replaces: 6034608, N806667-S
RETAINER-HEADLINER, FRONT FENDER
 Plastic
 Hole: M6.3, Head: 18MM, P.R.: 2.25-4.75MM
 Jeep Gr. Cherokee '91/ Ford
 UNIT PACKAGE 25

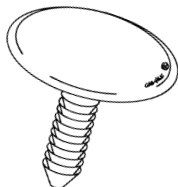

99-8321

Replaces: TY98TL2AA
RETAINER - HEADLINER
 Plastic - Paint To Match
 Hole: M7, Hd: 35MM, Stem Lgth: 19MM, O/L: 21.5MM, P.R.: 3.0-13.0MM
 Chrysler Mini Vans 2001/
 UNIT PACKAGE 25



96-7517

Replaces: 6504043
RETAINER-TRUNK TRIM
 Hole: M8.2, Head: 15MM
 Stem Length: 19MM
 Chrysler, Cirrus, Stratus '96/
 UNIT PACKAGE 50



72-3704

Replaces: 332364, 20732399, 25655537, 4004569, 389358-S, W701259-S300, 3691590, 6031321, 6505411, 6505425
RETAINER-FENDER, BUMPER, HOOD SEAL & INTERIOR TRIM
 Hole: 1/4", Head: 11/16", Stem Lgth: 5/8"
 G.M., Hummer, AMC, Ford & Chrysler
 UNIT PACKAGE 100
J04444
 UNIT PACKAGE 50

**96-7524**

Replaces: 34202335
RETAINER-CARGO BOX PANEL
 Hole: M7, Head: 13MM
 Stem Length: 15MM
 Black Plastic
 Dodge Pick-ups '94/
UNIT PACKAGE 25

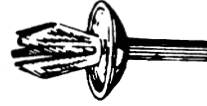
**78-4919**

Replaces: H447RB4
RIVET-HEADLINING
 Blue
 Omni & Horizon '79/
UNIT PACKAGE 50

78-4920

Replaces: H447RR5
RIVET-HEADLINING
 Red
 Omni & Horizon '79/
UNIT PACKAGE 50

**80-5248**

Replaces: 301989
RETAINER-DASH PANEL
 Chrysler Products '78/
UNIT PACKAGE 50

78-4922

Replaces: H447SG6
RIVET-HEADLINING
 Light Green
 Omni & Horizon '79/
UNIT PACKAGE 50

78-4921

Replaces: H447RX9
RIVET-HEADLINING
 Black
 Omni & Horizon '79/
UNIT PACKAGE 50

78-4923

Replaces: H447ST4
RIVET-HEADLINING
 Tan
 Omni & Horizon '79/
UNIT PACKAGE 50

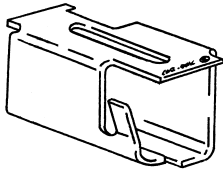
**99-8068**

Replaces: 6505141AA
GROMMET NUT-INTERIOR TRIM
 LIFTGATE
 Hole: 9 x 16MM, Screw: M4.2
 Jeep Cherokee 6/97 & up
UNIT PACKAGE 25

**78-4760**

Replaces: 6030925
CLIP-STEERING COLUMN SUPPORT
 HANGER
 Chrysler Products '78/
UNIT PACKAGE 100

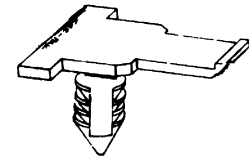
**83-5635**

Replaces: 6016114
RETAINER-HEATER MOTOR MOUNTING
 Black Plastic
 Chrysler '82
UNIT PACKAGE 25

GRILLE / COWL & SPLASH SHIELD

**76-4247**

Replaces: 6003315
RETAINER-GRILLE MOULDING
 Chrysler Products
UNIT PACKAGE 100

**69-3327**

Replaces: 2998638
CLIP-GRILLE ATTACHMENT FOR
 PLASTIC GRILLE
 Valiant, Dart, Belvidere,
 Coronet '70
UNIT PACKAGE 25

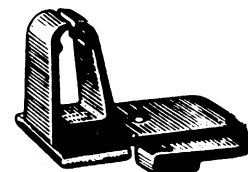
**72-3588**

Replaces: 3443540
CLIP-GRILLE, LOWER
 Nylon
 Valiant '71 - '72
UNIT PACKAGE 50

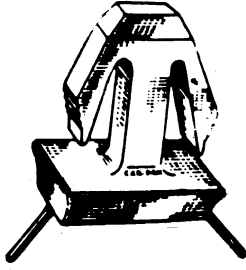

74-4082

Replaces: 3691466
RETAINER-GRILLE MOUNTING
 Dodge Dart & Valiant '74 - '75
 UNIT PACKAGE 100



78-4821

Replaces: 6031234
GROMMET-GRILLE MOUNTING
 Plastic
 Hole: 7x12.7MM, Flange: 12.7x14MM,
 P.R.: 0.8-4.3MM, Screw: #10 (M4.8)
 Chrysler Products '77/
 UNIT PACKAGE 50



77-4649

Replaces: 1386805, 6032676
NUT-RADIATOR GRILLE
 No. 8 or 10 Screw
 Chrysler Truck '85
 Buick & General Purpose
 UNIT PACKAGE 100

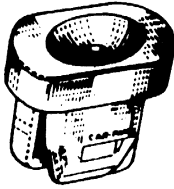

75-4137

Replaces: 6030519
NUT-GRILLES
 Chrysler Products '74 - '75
 UNIT PACKAGE 50

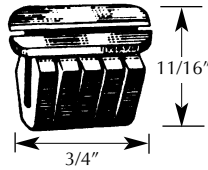

78-4819

Replaces: 1264963, 10032838
 8934-201-602, 6031869
GROMMET-MULTI PURPOSE HOOD
HINGE GRILLE & FLOOR TRIM RET.
 Buick '79/, Fiero '84/, Chrysler
 AMC Alliance & Ford Truck
 UNIT PACKAGE 50

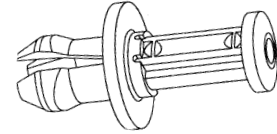

99-8498

Replaces: 11561349, 6507669AA
RIVET-DRIVE TYPE
 Radiator Grille, Bumper
 Plastic
 Hole: M10, Flange: 20MM,
 Stem Lgth.: 16MM, P.R.: 7.4MM
 G.M. 'U' Vans 2005/ & Dodge Durango
 2004
 UNIT PACKAGE 25



84-5842

Replaces: 6032832
RETAINER-GRILLE PLATE
HOLD DOWN
 Plastic
 Chrysler '85/
 UNIT PACKAGE 50



87-6286

RETAINER-FRONT
FASCIA GRILLE
 Hole: M3.5, Head:10MM
 Length: 20MM
 Black Plastic
 Chrysler Lancer &
 Lebaron GTS '86/
 UNIT PACKAGE 50

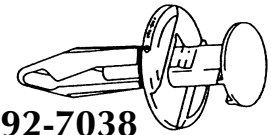

92-7038

Replaces: 5485676, 15691478,
 15969147, 21030249, N807389-S,
 W711035-S300, 6503598
RIVET-DRIVE TYPE FENDER APRON,
BUMPERS & GRILLES
 Hole: M8, Flange: 20MM, P.R. 3-8MM
 Plastic
 G.M. Saturn '91/, G.M. C/K Truck '99/ &
 Hummer, Chrysler '95-2000, Ford 2006/
 Dodge Nitro 2007/ Jeep 2005/
 UNIT PACKAGE 50

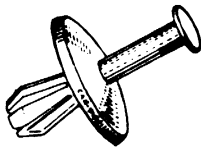

99-8081

Replaces: 6031383
RIVET-DRIVE TYPE,
GRILLE MOUNTING
 Plastic
 Chrysler Products '78/
 UNIT PACKAGE 15



99-8184

Replaces: 51161-881-149, 000-990-34-92,
 N102-593-01, 5073327AA
RIVET-DRIVE TYPE
 Front Bumper
 Plastic
 Hole: M5, Flange: 10MM, P.R.: 3-8MM
 BMW 3, 5 & 8 Series '91/,
 Mercedes GL, M, SL & SLK '98/,
 VW, Dodge Pick-Up 2002/
 UNIT PACKAGE 50



99-8778

Replaces: 11562364, 4806226AA
CLIP-RADIATOR GRILLE
& REAR BUMPER
 Buick Lucerne, Cadillac CTS 2006/
 Chrysler 300, Dodge Nitro,
 Jeep Commander 2005/
 UNIT PACKAGE 15

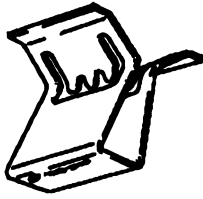

98-7783
Replaces: 4676356
RETAINER-RADIATOR GRILLE
Chrysler Mini Van '96/
UNIT PACKAGE 25

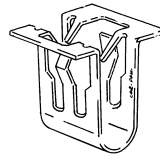

98-7804
Replaces: 6502988
CLIP-GRILLE
Metal
Zinc Finish
Chrysler '96/
UNIT PACKAGE 15

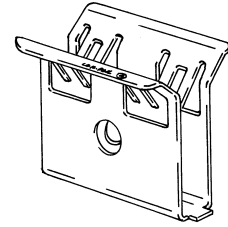

99-8264
Replaces: 4805570AA
CLIP - FRONT RADIATOR GRILLE COVER
25MM Square
Chrysler Mini Vans '96/
UNIT PACKAGE 10



98-7803
Replaces: 6100814
NUT-THREAD CUTTING TYPE
Grille Emblem
M6 Stud Size, 11MM Hex, 15MM Integral
Faceted Washer
Zinc Finish
Chrysler LH, Concorde, Intrepid '96/
UNIT PACKAGE 100

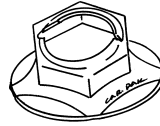

98-7802
Replaces: 4856880
NUT-THREAD CUTTING TYPE
Grille Emblem
5/16" Stud Size, 1/2" Hex, 7/8" Integral
Faceted Washer
Zinc Finish
Chrysler Cirrus, Stratus, Breeze '95/
UNIT PACKAGE 25

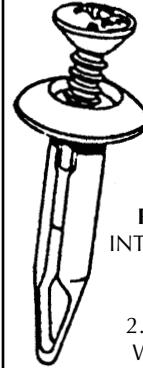

86-6096
Replaces: N-804570-S,
20664092 & 6502790
RIVET-COWL & VARIOUS
INTERIOR TRIM APPLICATIONS
(Screw Type)
Black Plastic, Hole: M6.3
2.5MM - 8.0MM Grip Range
Washer Face Dia.: 18.0MM
Ford, G.M., Chrysler Products
& Cadillac '98/
UNIT PACKAGE 25

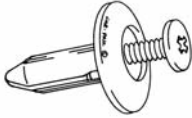

99-8767
Replaces: W706092-S300,
6508197AA, 2028654C1
RIVET-SCREW TYPE,
SHIELDS & GRILLES, Plastic
Hole: M6.4-6.9, Flange: 17.8MM,
Stem Lgth: 18MM, P.R.: 3-5MM
Ford Taurus 2008/,
Dodge PU 2002/ & Navistar
UNIT PACKAGE 25

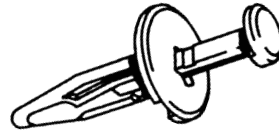

93-7145
Replaces: 10134407, 15990756,
F50C-9E728-AA, 6501925
RIVET-DRIVE TYPE, BUMPER,
ROCKER MOULDING
Hole: M6.3, Flange: 17MM
P.R.: 1.52MM - 7.62MM
Chrysler "LH" '93/, Dodge Nitro 2007/,
Jeep Liberty 2002, Dodge Journey 2009
Ford & G.M., Hummer H2
UNIT PACKAGE 25

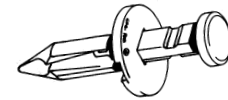

99-8251
Replaces: 6506132AA
RIVET-DRIVE TYPE
Side Radiator Shield
Plastic
Hole: M7, Flange: 20MM,
Stem Lgth: 17MM, P.R.: 2.65MM
Chrysler Sebring, 300,
Dodge Stratus Magnum, Charger 2001/
UNIT PACKAGE 25

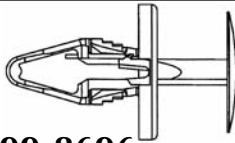

99-8696
Replaces: 11589289, W713610-S300,
6508863AA
RIVET-DRIVE TYPE, Flares, Cowl,
RKR Moulding,, Front Bumper, Plastic
Hole: M6.25-6.53, Flange: 18MM,
Stem Lgth: 17.5MM, P.R.: 2-4MM
G.M. Equinox & Torrent 2007,
Buick Enclave, Saturn '91/,
Ford Focus 2008/ & Dodge PU 2009/
UNIT PACKAGE 25

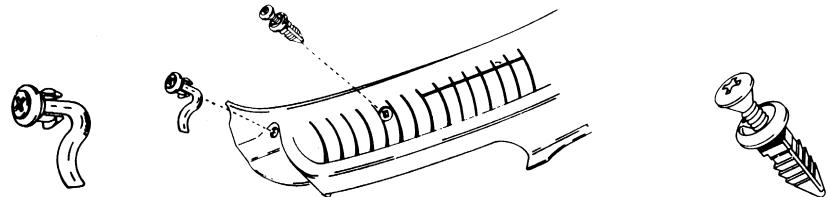

93-7177
Not Available From O.E.
RETAINER-COWL SCREEN
Plastic
Chrysler "LH" Models '93/
UNIT PACKAGE 15

93-7176
Replaces: 6502573
RIVET-SCREW TYPE, COWL SCREEN
Hole: 1/4" Sq., Flange: 15/32"
Plastic
Chrysler "LH" Models '93/
PT Cruiser 2001/
UNIT PACKAGE 15

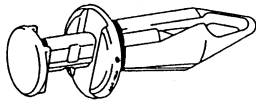

92-7025

Replaces: 20730531, 21077123,
W705436-S300, 6509103AA
**RIVET-DRIVE TYPE, COWL VENT, GRILLES,
BUMPERS & FENDERS SHIELDS**
Plastic
Hole: M6, Flange: 15MM, P.R.: 5MM
G.M., Saturn '91-2007, Ford 2002/
Dodge Journey 2009/
UNIT PACKAGE 25

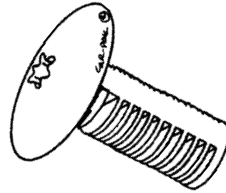

99-8411

Replaces: 6506306AA
RETAINER-COWL SCREEN
W/Torx recess - Plastic
Head: 25MM, O/L: 16.2MM,
Fits 1/4-20 stud
Dodge Dakota '97/
UNIT PACKAGE 15



94-7254

Replaces: 6503339
RETAINER-COWL SCREEN
w/Torx Recess Used w/94-7253
Plastic
Fits 1/4-20 Stud, Head: 21MM, O/L:
13.5MM
Dodge Ram Full Size Pick-up '94/
Gr. Cherokee '99/
UNIT PACKAGE 15

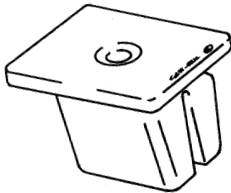

99-7924

Replaces: 4805119
GROMMET-COWL VENT
Screw: M4.8, Hole: 9X13MM,
Flg: 14 x 17MM
Plastic
Chrysler LH, 300M '98/ Neon 2000
UNIT PACKAGE 25



94-7253

Replaces: 6503336
RETAINER-COWL SCREEN
Used w/94-7254 & 98-7892
Plastic
Hole: 1/4", Stud: 1/4 - 20,
Flange: 9/16", O/L: 1"
Dodge Ram Full Size Pick-up '94/
UNIT PACKAGE 15

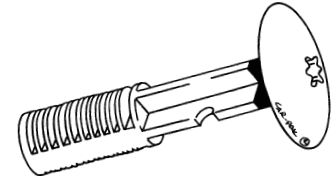

98-7892

Replaces: 6505319AA
RETAINER-COWL SCREEN
w/Torx Recess, use with 94-7253
Plastic
Fits 1/4-20 Stud, Head: 21MM,
O/L: 37.3MM
Jeep Gr. Cherokee '99/
UNIT PACKAGE 25



92-7005

Replaces: 6501699
GROMMET-COWL SCREEN
Hole: M7 Sq., Screw: M4.2
Plastic
Chrysler Minivans &
Various Cars '90/
UNIT PACKAGE 25

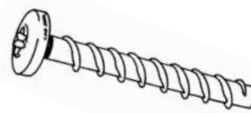

97-7701

Replaces: 4630760
SCREW-THREAD FORMING
Black Finish
M5 X 31MM T25 Torx Pan Head
Use With 97-7694 Cowl Grommet
Chrysler, Cirrus & Stratus '95/
UNIT PACKAGE 50

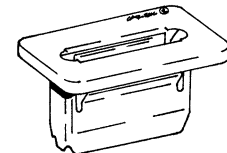

97-7694

Replaces: 4630760
GROMMET-NUT
Cowl & Dash
Plastic
Hole Dia: 8 x 19MM
Flange: 16 x 28MM, Screw: M5
Chrysler, Cirrus, Stratus '95/
UNIT PACKAGE 10

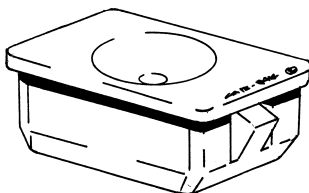

99-8467

Replaces: 4860375AB
GROMMET-COWL VENT
Plastic
Hole: 16x20MM Slot, Flange: 14x20MM,
P.R.: 1.5MM, Screw: M4.8 (#10)
Chrysler Mini Van 2004
UNIT PACKAGE 50



77-4692

Replaces: 387258-S
20032850, 3861577
RETAINER-STONE SHIELD
Ford, Chrysler & G.M. '76
UNIT PACKAGE 100

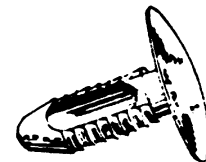

84-5839

Replaces: 6501067
**RETAINER-LOWER BODY SIDE
MOULDING, FASCIA
COMPONENTS AIR DAM & GENERAL
USAGE**
Plastic
Grand Cherokee '93, Chrysler "K", "LH",
Omni & Viper '84/
UNIT PACKAGE 50

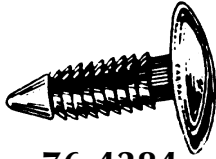

76-4384

Replaces: 1605396, 15958694, 6030441,
6502078, 388577-S, 6036007AA
**RETAINER-PLASTIC SHIELD, FENDERS
AND ENGINE COMPARTMENT**
G.M. Cars '76/, Chrysler Products '76/,
Ford Products '76/, Jeep Liberty 2002
UNIT PACKAGE 100
J05546
UNIT PACKAGE 50

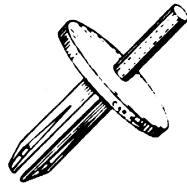

78-4801

Replaces: 6031390
RIVET-DRIVE TYPE,
SPLASH SHIELDS
Chrysler Products '79/
UNIT PACKAGE 50

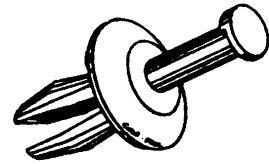

99-7925

Replaces: 6504090
RIVET-DRIVE TYPE, HOOD, INSULATOR
Hole:M6.3, Flange:17MM, P.R.:1.5-7.6MM
Plastic
Chrysler LH, 300M '99/, Dodge Nitro 2007/
UNIT PACKAGE 50

BUMPER / LIGHT / TRUNK



69-3271

Replaces: 2964591
SUPPORT ASSEMBLY-DECK
OPENING UPPER PANEL
Plymouth, Dodge, 4-Door
Hardtops '70
UNIT PACKAGE 50

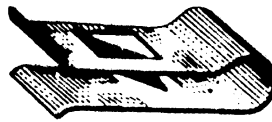

72-3707

Replaces: 6029117
CLIP-GRILLE TO FRONT BUMPER
Chrysler '72
UNIT PACKAGE 100



99-8793

Replaces: 6505223AA
NUT-SNAP IN STYLE, FRT. BUMPER,
DOOR GLASS & GRILLES
Hole: M14sq, O/L: 13MM,
Screw: M6-1.0
Chrysler 300 2005/ &
Jeep Gr Cherokee '99/
UNIT PACKAGE 10

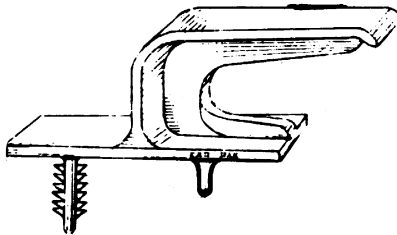

80-5268

Replaces: 4074502
SPACER-FRONT BUMPER FILLER
Chrysler Products '81/
UNIT PACKAGE 25



99-8655

Replaces: 5159077AA
RETAINER-REAR BUMPER
Plastic
Jeep Gr. Cherokee 2005/
UNIT PACKAGE 25

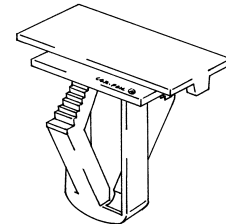

99-8286

Replaces: 55156429AA
RETAINER - BUMPER FASCIA
Plastic
Jeep Liberty 2002
UNIT PACKAGE 5

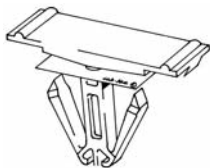

99-8753

Replaces: 6508947AA
RETAINER-FRONT BUMPER
Plastic
Hole: M15, Top Hd: 11x32MM,
O/L: 26MM
Jeep Patriot 2007/
UNIT PACKAGE 10

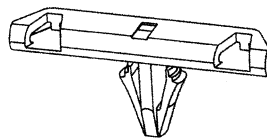

99-8414

Replaces: 4857699AA
RETAINER-FRONT BUMPER
FASCIA TO GRILLE
Plastic
Hole: M7.5, Head: 10x42MM, P.R.: 3MM
Chrysler Pacifica 2004
UNIT PACKAGE 25

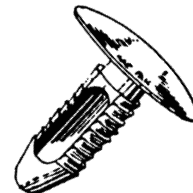

81-5428

Replaces: 22512276, 6503221
RETAINER-REAR BUMPER FASCIA
& BUMPER AIR DAM
G.M. '80/, "C" Body '85/,
Chrysler Trucks '97/
UNIT PACKAGE 50

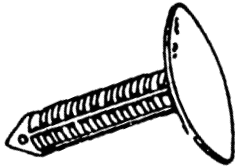
**96-7551**

Replaces: 6502104
**RETAINER-H/L MOUNTING TO
 CROSSMEMBER**
 Hole: M6.5, Head: 25MM
 O/L: 29.75MM
 Black Plastic
 Dodge Daytona '93/
UNIT PACKAGE 15

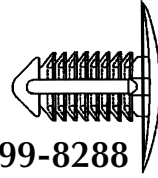
**99-8288**

Replaces: 22189414
**RETAINER - STRUT MOUNTING,
 FRONT SPRING INSULATOR,
 FRONT BUMPER**
 Plastic Textured
 Hole: M9, Head: 24MM,
 Stem Length: 19MM, P.R.: 1.6-10.0MM
 G.M. 'B', 'C', 'H', 'K' & 'U' Bodies '99/
 Jeep Grand Cherokee '99/02
UNIT PACKAGE 25

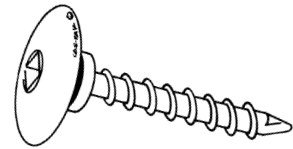
**97-7638**

Replaces: 6503819, 25631448
SCREW- SQUARE DRIVE TRUSS HEAD
 Plastic-Black
 M7.5 x 34.5MM
 Head Dia: 22MM, Shoulder: 4 x 9MM
 Attaches Foam to Bumper Fascia
 Chrysler '94/
 G.M. '97/
UNIT PACKAGE 15

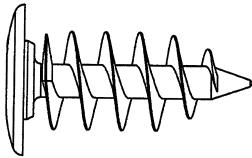
**99-8656**

Not Supplied by O.E.
SCREW-BUMPER & DOOR INSULATORS
 Plastic, Truss Head
 Hole: M12, Head: 22MM, O/L: 36MM,
 Thread Dia.: 14MM, Drive: #3 Square
 G.M., Ford & Chrysler 2005/
UNIT PACKAGE 25

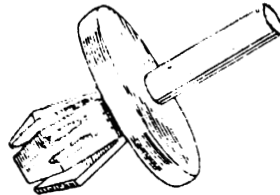
**78-4901**

Replaces: 6031548
**RIVET-DRIVE TYPE, FRONT BUMPER
 STRIP**
 Chrysler Products '79/
UNIT PACKAGE 50

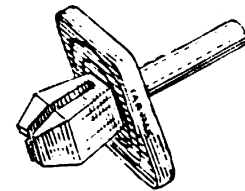
**80-5259**

Replaces: 6031548
**RIVET-DRIVE TYPE,
 FILLER STRIP TO BUMPER**
 Chrysler Newport & New Yorker,
 Plymouth Grand Fury '79/
UNIT PACKAGE 50

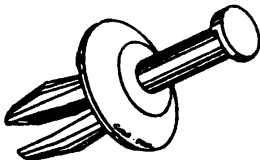
**98-7821**

Replaces: 6503454
RIVET- PIN DRIVE TYPE
FRONT BUMPER FASCIA
 Plastic
 Hole: M6.35, Flange: 18MM, P.R.: 2-6MM
 Jeep Grand Cherokee 394/
UNIT PACKAGE 25

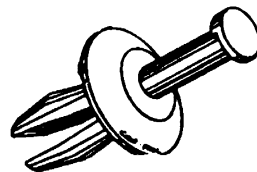
**82-5486 (J05502)**

Replaces: 14019206, 34201621
**RIVET-DRIVE TYPE, FENDER APRON
 BUMPER COVER**
 Hole: 1/4", P.R.: 1/16" - 7/32"
 Washer Face: 11/16"
 Black Plastic
 G.M. '83/, Ford, Chrysler LH & Pacifica
UNIT PACKAGE 50

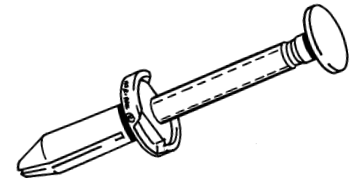
**98-7811**

Replaces: 6504521
RIVET- PIN DRIVE TYPE
BUMPER & GRILLE
 Hole: M8.5, Flange: 18MM, P.R.: 4-8MM
 Chrysler "LH", Sebring, Charger,
 Magnum, Viper & Journey '98/
UNIT PACKAGE 25

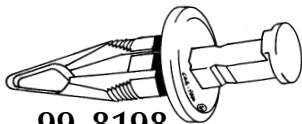
**99-8198**

Replaces: 11517803, 11519444,
 4857753AA, W709984-S300
RIVET-DRIVE TYPE. Plastic
 Cowl, Bumper Cover & Grille, Front Lamps
 Hole: M10, Flange: 18MM,
 Stem Lgth.: 26MM, P.R.: 6.2-8.7MM
 G.M. 'W' & 'U' Bodies '97/
 'B' Bodies 2001/ Lt. Duty Trucks, Cadillac
 XLR, Pontiac G6 2005/, SAAB 9-7X 2005/
 Saturn 2000/, Ford Flex 2009
UNIT PACKAGE 25

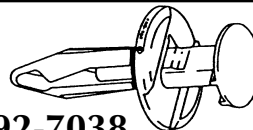
**92-7038**

Replaces: 5485676, 15691478,
 15969147, 21030249, N807389-S,
 W711035-S300, 6503598
**RIVET-DRIVE TYPE FENDER APRON,
 BUMPERS & GRILLES**
 Hole: M8, Flange: 20MM, P.R. 3-8MM
 Plastic
 G.M. Saturn '91/, G.M. C/K Truck '99/ &
 Hummer, Chrysler '95-2000, Ford 2006/
 Dodge Nitro 2007/ Jeep 2005/
UNIT PACKAGE 50

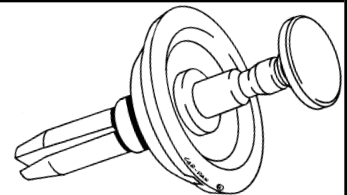
**98-7877**

Replaces: 4805405AA, 1L5Z-17K826-AA
RIVET-DRIVE TYPE, FRONT BUMPER
 Hole: M8.5, Flange: 34MM
 P.R.: .5-2.0MM, Shoulder: 3.5 x 11MM
 Chrysler Concord, Intrepid, 300M
 PT Cruiser '98/, Pacifica 2004,
 Ford Explorer
UNIT PACKAGE 15

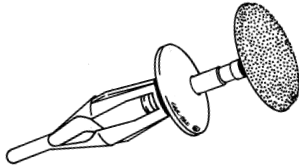
**98-7850**

Replaces: 5BB14LX9
RETAINER-BUMPER COVER
 Plastic
 Hole: M6.3, Head: 19MM, Flange: 15MM
 P.R.: 5.6-8.5MM
 Dodge Dakota '94/
UNIT PACKAGE 25

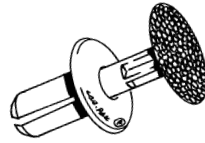
**99-8315**

Replaces: MR478262
RIVET - DRIVE TYPE
 Bumper Cover & Garnish Moulding
 Plastic w/Textured Head, Use w/99-8314
 Hole: M7, Head: 15MM,
 Flange: 14MM, Stem: 13MM
 Chrysler Sebring & Stratus 2001/
 Mitsubishi Eclipse 2000/
UNIT PACKAGE 15

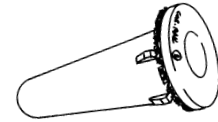
**99-8314**

Replaces: MR478263
**GROMMET - BUMPER COVER &
 GARNISH MOULDING**
 Rubber w/Seal, Use w/99-8315
 Hole: M9, Flange: 15.5MM,
 O/L: 21.5MM, P.R.: 1.5MM
 Chrysler Sebring & Stratus 2001/
 Mitsubishi Eclipse 2000/
UNIT PACKAGE 15

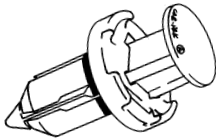
**99-8316**

Replaces: MR200300
RIVET - DRIVE TYPE
 Bumper Cover & Interior Trim
 Plastic
 Hole: M9, Flange: 18MM,
 Stem: 13MM, P.R.: 7MM
 Chrysler Sebring & Stratus 2001/
 Mitsubishi '97/
UNIT PACKAGE 25

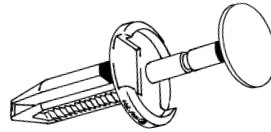
**99-8236**

Replaces: 6506008AA
RIVET - DRIVE TYPE
 Front Bumper Cover
 Plastic
 Hole: M6.25, Flange: 17MM
 Stem Lgth.: 16.3MM, P.R.: 5-7MM
UNIT PACKAGE 25

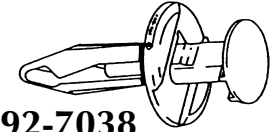
**92-7038**

Replaces: 5485676, 15691478,
 15969147, 21030249, N807389-S,
 W711035-S300, 6503598
**RIVET-DRIVE TYPE FENDER APRON,
 BUMPERS & GRILLES**
 Hole: M8, Flange: 20MM, P.R. 3-8MM
 Plastic
 G.M. Saturn '91/, G.M. C/K Truck '99/ &
 Hummer, Chrysler '95-2000, Ford 2006/
 Dodge Nitro 2007/ Jeep 2005/
UNIT PACKAGE 50

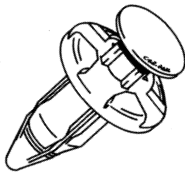
**98-7854**

Replaces 01553-0932, MR3289541
RIVET-DRIVE TYPE (REUSABLE)
 Plastic-Front Fender & Bumper
 Hole: M8, Flange: 20MM, P.R.: 4MM
 Nissan '94/, Infinity '93/
 & Chrysler/Mitsubishi '99/
UNIT PACKAGE 15

**90-6806**

Replaces: 96057846, 09409-07308-281,
 MB475404, 90467-07076
RIVET-DRIVE TYPE (Removeable)
 COWL, FRONT BUMPER
 Plastic
 Hole: M6, Washer: 15MM, P.R.: 2-5MM
 Toyota Rav 4, G.M. Geo Tracker '89/
 Chrysler & Mitsubishi '95/
 Suzuki Sidekick '89/
UNIT PACKAGE 10

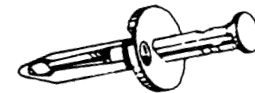
**85-5945**

Replaces: N803709-S,
 15681408, 4857108
**RIVET-DRIVE TYPE, BUMPER,
 FASCIA & FENDER APRON, Plastic**
 Hole: M6.3, P.R.: 5-10MM,
 Flange: 15MM
 Ford '86/, G.M.,
 Chrysler '97/ & Jeep 2005/
UNIT PACKAGE 50

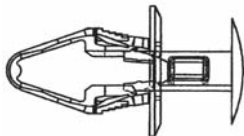
**99-8580**

Replaces: 11561368, 6508712AA
**RIVET-DRIVE TYPE, FENDER,
 WHEEL & BUMPER**
 Plastic
 Hole: M9.25-9.53, Flange: 18MM,
 Stem Lgth: 20MM, P.R.: 3.0-5.7MM
 G.M. 'W' & 'M' Body 2006,
 Jeep Wrangler 2006/
UNIT PACKAGE 25

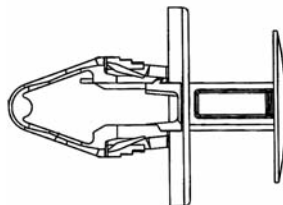
**99-8700**

Replaces: 11589295, 5GUU9K111BA,
 W712665-S300
**RIVET-DRIVE TYPE,
 BUMPERS, FUEL TANK SHIELD, Plastic**
 Hole: M10.25-10.53, Flange: 25MM,
 Stem Lgth: 20MM, P.R.: 3-6MM
 G.M. HHR, G5, G6 & C/K TRUCKS 2005/
 Saturn Vue 2008/, Saab 9-3 2008
 Chrysler & Ford
UNIT PACKAGE 25

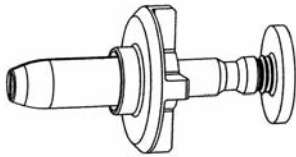
**99-8512**

Replaces: 4806110AA, 4389947AA
RIVET- FRONT & REAR BUMPERS
 Plastic
 Hole: M8.5, Flange: 24MM,
 Stem Lgth: 20.5MM,
 P.R.: 0.5-2.0MM, Shoulder: 3.5 x 11MM
 Chrysler 300, Sebring & Dodge Magnum
 2005/ & Dodge Journey 2009/
UNIT PACKAGE 15

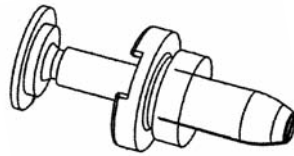
**99-8513**

Replaces: 4806240AA, 4806240AB
RIVET- REAR BUMPER
 Plastic
 Hole: M8, Flange: 18.5MM,
 Stem Lgth: 20.5MM,
 P.R.: 0.5-1.5MM, Shoulder: 1.8 x 11MM
 Chrysler 300 & Dodge Magnum 2005
UNIT PACKAGE 10

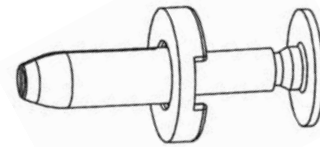
**99-8658**

Replaces: 5160260AA
RIVET-DRIVE TYPE, REAR BUMPER,
 TAIL LAMP, FENDER, Plastic
 Hole: M8, Flange: 18MM,
 Stem Lgth: 20MM, P.R.: 2.6-3.0MM
 Dodge Caliber,
 Jeep Compass & Patriot 2007/
UNIT PACKAGE 15

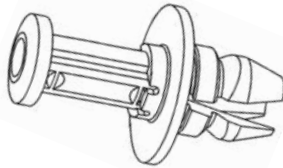
**99-8659**

Not Supplied by O.E.
RIVET-DRIVE TYPE,
REAR BUMPER MOUNTING BRACKET
 Plastic
 Hole: M10.5 Slot & M9.75 Hole,
 Flange: 22MM, Stem Lgth: 15MM
 Jeep Commander 2006/
UNIT PACKAGE 15

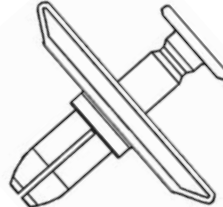
**99-8550**

Replaces: 55157112AA, 55157112AB
RIVET-DRIVE TYPE, BUMPER COVER
 Plastic
 Hole: M9.75, Flange: 25.x45.MM,
 P.R.: 1.25MM, Shoulder: 2x10MM
 Jeep Gr. Cherokee 2005
UNIT PACKAGE 15

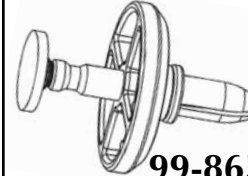
**99-8657**

Replaces: 4806334AA
RIVET-DRIVE TYPE, REAR BUMPER
 Plastic w/Seal
 Hole: M8.5, Flange: 34MM,
 Stem Lgth: 17MM,
 Shoulder: 3.5x11MM, P.R.: 0.5-1.5MM
 Dodge Caliber,
 Jeep Patriot & Compass 2007/
UNIT PACKAGE 10

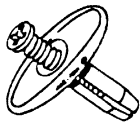
**88-6464**

Replaces: 6501630, 6501772
RIVET-SCREW TYPE, ATTACH REAR BODY
PANEL FILLER
 Hole: M6.3, Oval Head: 15.0 x 31.0MM
 Plastic
 Chrysler Daytona '87/
UNIT PACKAGE 15

**89-6652**

Replaces: 10140480, 6502625
RIVET-SCREW TYPE,
BUMPER FASCIA ATTACHMENT
 Hole: M12, Flange: 21MM
 Shoulder: 3MM
 Plastic
 G.M. "U" & APV Van '90/
 Chrysler "LH" Models '93/, Durango '98/
UNIT PACKAGE 25

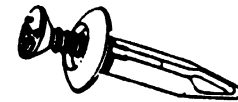
**96-7516**

Replaces: 4696488, 10195515,
 N805026-S
RIVET-SCREW TYPE, REAR BUMPER
 Hole: M7, Head: 12.5MM
 P.R.: 2-7MM, Stem Length: 30MM
 Chrysler Cirrus, Stratus '96/
UNIT PACKAGE 15

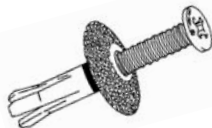
**97-7704**

Replaces: MB888869, 90505-SL0-003,
 90467-08155
RIVET-SCREW TYPE
 Bumper Cover
 Plastic
 Hole: M8, Stem: 20.5MM,
 Panel: 13MM, HD 20MM
 Chrysler, Mitsubishi, Acura, Toyota '93/
UNIT PACKAGE 15

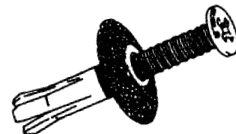
**98-7789**

Replaces: MR138807
RIVET-SCREW TYPE, BUMPER COVER
 Plastic
 Hole: M8, Flange: 20MM
 Max G.R.: 20MM
 Chrysler Sebring '96/
 Mitsubishi Eclipse '94/
UNIT PACKAGE 5

**91-6953**

Replaces: 63854-01A00, MB547806
RIVET-SCREW TYPE, BUMPERS
 Plastic Textured Finish
 Hole: M8, Washer Face: 20MM
 G.R.: 4MM-8MM
 Nissan 300ZX '90/, Chrysler
 & Mitsubishi '90/
UNIT PACKAGE 15

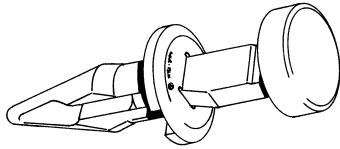
**99-8237**

Replaces: 4857345AA
RIVET - DRIVE TYPE
 Tail Lamp Housing Mounting
 Plastic
 Hole: M9.5, Flange: 21MM,
 Stem Lgth.: 23MM
 P.R.: 3.5-5.5, Pin Hd. Dia.: 17.5MM
 Chrysler Mini Van 2002
UNIT PACKAGE 25

**99-8624**

Replaces: 55157330AC
RIVET-DRIVE TYPE, TAIL LAMP
 Plastic
 Hole: M8 sq., Flange: 20MM,
 Head: 31MM, Stem Length: 21MM,
 Shoulder: 10 x 3.5MM
 Jeep Commander 2006/
UNIT PACKAGE 15

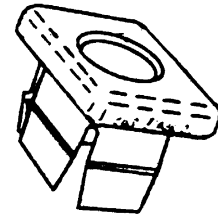
**86-6156**

Not Supplied By O.E.
GROMMET-BUMPER GUARD
 Hole: 10MM Sq., P.R.: 6MM, Screw: M8
 Plastic
 Chrysler
UNIT PACKAGE 25

**96-7518**

Replaces: 6501773
GROMMET-TAIL LAMP
 Hole: M10, Head: 17.75 Sq.
 Screw: M6
 Plastic
 Chrysler Cirrus, Stratus '96/
UNIT PACKAGE 50

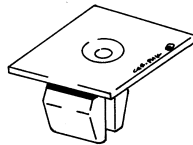
**99-8153**

Replaces: 6035401
GROMMET-DOOR PANEL, BUMPER
 Plastic
 Hole: M9 SQ., Flange: 16MM SQ.,
 Screw: M4.2 (#8)
 Chrysler Mini Vans '97/, Pacifica 2004,
 Jeep Patriot 2007/, Dodge Journey 2009
UNIT PACKAGE 50

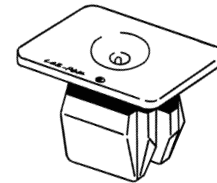
**98-7878**

Replaces: 6505161AA
GROMMET-FRONT & REAR FASCIA
 Plastic
 Screw: M4.2, Hole: 9 x 13MM
 Flange: 14 x 18MM, P.R.: 8-17MM
 Chrysler LH & LHS '98/
UNIT PACKAGE 25

**99-8661**

Replaces: 14083173, 17988488,
 17997722, 25536302, N803685-S
NUT-SNAP IN STYLE
 Front Bumper, Side/High Stop Lamps,
 Rear Wheel
 Flare & Interior Trim/Dash Mountings
 Screw: M4.2 (#8), Hole: 9x11MM
 G.M., Saturn, Hummer, Ford & Jeep '82/
UNIT PACKAGE 25

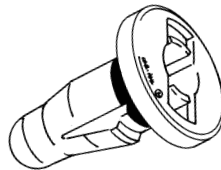
**99-8250**

Replaces: MB271999
RETAINER - BUMPER COVER
 Plastic
 Hole: M13, Flg: 24MM, O/L: 24MM
 Chrysler Colt, Sebring/Stratus '89/
 Eagle '89-'96
 Mitsubishi Eclipse, Galant, Mirage '93/
UNIT PACKAGE 10

**99-8623**

Replaces: 55156879AB
GROMMET-TAIL LAMP
 Plastic
 Receives 10MM Ball Stud
 Jeep Commander 2006/
UNIT PACKAGE 25

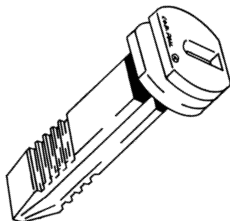
**98-7875**

Replaces: 4805333AA
RETAINER PIN-FRONT FASCIA
 Plastic
 (Use with 98-7876)
 Chrysler Concord & LHS '98/
UNIT PACKAGE 25

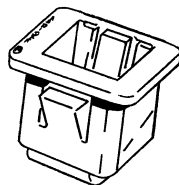
**98-7876**

Replaces: 4805336AA
GROMMET-FRONT FASCIA
 Plastic
 Hole: 9 X 12MM
 (Use with 98-7875)
 Chrysler Concord & LHS '98/
UNIT PACKAGE 25

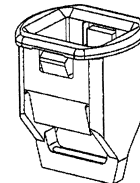
**99-8496**

Replaces: 4857751AA
RETAINER-TAIL LAMP
 Plastic
 Slot: 13x16MM, Flange: 17x18.5MM,
 P.R.: 0.7-0.9MM
 Chrysler Pacifica 2004/
UNIT PACKAGE 25

**99-7994**

Replaces: 6504072
GROMMET-TAIL LAMP HSG MOUNT
 Plastic
 Hole: M12, Flange: 16MM, PR: .9MM
 Dodge Dakota & Ram Trucks '97/
UNIT PACKAGE 25

**99-8123**

Replaces: 4759514AB
GROMMET-FLOOR PAN PLUG & LUGGAGE COMPARTMENT CARPET Rubber
 Hole: M9, Flange:15MM, Holds M6-M6.3
 XMAS TREE RETAINERS
 Chrysler LH, LHS & Concorde '97/
UNIT PACKAGE 50

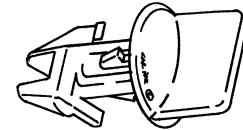
**98-7872**

Replaces: 25535963, N811772-S, 5183468AA
RETAINER-SIGHT SHIELD & H/L SHROUD COVER
 Plastic - Twist Lock
 G.M. "C", "H" & "N" Bodies '94 - '96
 Ford Full Size & Lincoln T. Car '98/
 Jeep Commander 2006/
UNIT PACKAGE 15

**94-7256**

Replaces: 34201631
BLIND RIVET-SUPER TOUGH NYLON BLACK BUTTON HEAD BUMPER SPLASH SHIELD
 Hole: M6.3, Flange: 17MM
 G.R.: .157 - 394 (4 - 10MM)
 Dodge Ram Full Size Pick-up '94/
 Jeep '81/, Durango '98/
UNIT PACKAGE 25

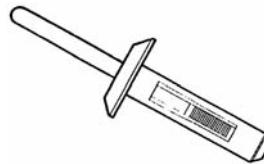
**94-7257**

Replaces: 6501559
BLIND RIVET-SUPER TOUGH NYLON BLACK TAPERED FLANGE HEAD
 Hole: M6.3, Flange: 13MM
 G.R.: .138 - 236 (3.5 - 6MM)
 Dodge Ram Full Size Pick-up '94/
UNIT PACKAGE 25

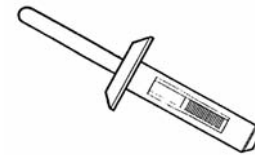
**97-7728**

Replaces: 6503938
BLIND RIVET-FRONT BUMPER Nylon-Black
 Rivet: M6.3\1/4", Panel
 Range: 4-7MM\5/32-9/64"
 Head Dia: 13MM\1/2" Tapered
 Dodge Pick Up Trucks '94/
UNIT PACKAGE 25

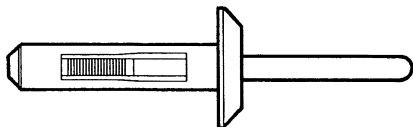
**99-7926**

Replaces: 6504700
BLIND RIVET-FRONT BUMPER Nylon - Black
 Rivet:M6.3, P.R.: 4-6MM, Flange:17MM
 Tapered
 Chrysler LH, 300M '99/
UNIT PACKAGE 25

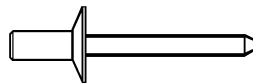
**97-7677**

Replaces: 6032138
RIVET- COUNTERSUNK CLOSED END Sealing Type
 Aluminum Rivet, Steel Mandrel
 5/32" Rivet, Flange Dia: 5/16"
 .126-.187 Grip Range
 Trunk Lock Cover
 Chrysler
UNIT PACKAGE 50

**98-7838**

Replaces: 6035414
RIVET- BLIND TYPE, MULTI GRIP STYLE BUMPER COVER Cladding to Fender
 1/8" Rivet, Flange: 5/16"
 G.R.: .062-.250
 Aluminum Rivet, Steel Mandrel
 Chrysler "LH" Models '97/
UNIT PACKAGE 50

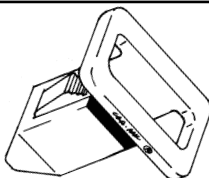
**99-8351**

NOT SUPPLIED BY O.E.
RETAINER - HEADLAMP MOUNTING PANEL
 Plastic
 Hole: 10 X 15MM, Flange: 16 x 22MM,
 O/L: 22MM,, P.R.: 3.3MM
 Jeep Gr. Cherokee '99/
UNIT PACKAGE 25

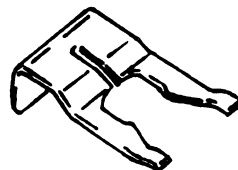
**95-7366**

Replaces: F97Z-13N129A, 5288722AA,
RETAINER-HEADLAMP ADJUSTING BAR & SIDE MARKER LAMPS
 To Header Panel
 Ford Ranger '93/, Mustang '94/,
 Chrysler Neon 2000/
UNIT PACKAGE 15

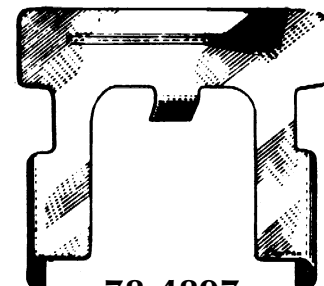
**78-4897**

Replaces: 4022390
CLIP-SIDE MARKER LIGHT RETAINING
 Volare & Aspen '77/
UNIT PACKAGE 50

AMERICAN MOTORS

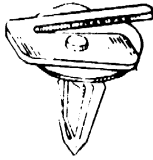
**78-4825**

Replaces: 4005539
RETAINER-MOULDINGS
 Plastic
 American Motors & Universal
UNIT PACKAGE 50

**J03887**

Replaces: 4002211
RETAINER-TRIM PANEL
 A.M.C. & Universal
UNIT PACKAGE 100

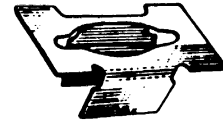
**77-4707**

Replaces: 554343, 3231651
CLIP-BUMPER STRIPS
 American Motors '77/
 Olds Buick, Chevrolet '77/
UNIT PACKAGE 100
J05208
UNIT PACKAGE 50

**J04310**

Replaces: C9AB-6220818A
CLIP-BODY SIDE MOULDING
 Plastic
 Ford & American Motors
UNIT PACKAGE 50

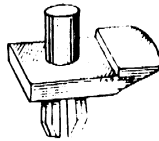
**78-4823**

Replaces: 4006046
RETAINER-MOULDING
 Plastic
 American Motors
UNIT PACKAGE 50

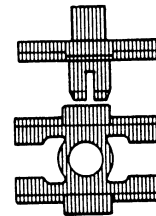
**J03890**

Replaces: 4000729
CLIP-MOULDING
 Drive Type
 Plastic
 American Motors & General Purpose
UNIT PACKAGE 50

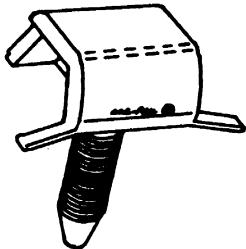
**87-6269**

Replaces: 8934-201-337
RETAINER-BODY SIDE MOULDING
 Plastic
 AMC Reliance & Encore '83/
UNIT PACKAGE 25

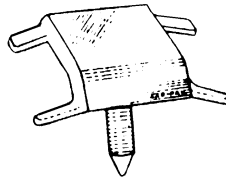
**79-5090**

Replaces: 4006380
**RETAINER-BODY SIDE & WHEEL
 FLAIR MOULDING**
 American Motors '80/
UNIT PACKAGE 50

**83-5640**

Replaces: 8934-201-767
**NUT-TUBULAR FOR USE ON
 THINNER BODY PANEL**
 Plastic
 Also Used on All AMC Lines
 Alliance '83
UNIT PACKAGE 50

**83-5618**

Replaces: 7703-077-066, 6501227
**RETAINER-REAR WINDOW MOULDING
 & DOOR PANEL**
 AMC-Renault Alliance '83
 Chrysler '85/
UNIT PACKAGE 25

**72-3704**

Replaces: 332364, 20732399, 25655537,
 4004569, 389358-S, W701259-S300,
 3691590, 6031321, 6505411, 6505425
**RETAINER-FENDER, BUMPER, HOOD
 SEAL & INTERIOR TRIM**
 Hole: 1/4", Head: 11/16", Stem Lgth: 5/8"
 G.M., Hummer, AMC, Ford & Chrysler
UNIT PACKAGE 100
J04444
UNIT PACKAGE 50

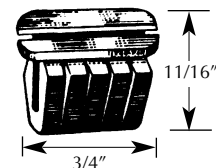
**78-4819**

Replaces: 1264963, 10032838
 8934-201-602, 6031869
**GROMMET-MULTI PURPOSE HOOD
 HINGE GRILLE & FLOOR TRIM RET.**
 Buick '79/, Fiero '84/, Chrysler
 AMC Alliance & Ford Truck
UNIT PACKAGE 50

UNIVERSAL

**"ERGOLOK"
DRIVE RIVETS
CAN BE USED FOR
UNAVAILABLE
DRIVE RIVETS**

**LOWER INSTALLATION EFFORT
GOOD RETENTION
CONSISTENT THROUGHOUT PANEL RANGES
WIDE HOLE DIAMETER RANGES
REUSABLE
HIGH SHEAR STRENGTH**

***CAR-PAK ALWAYS PROVIDES
THE MOST CURRENT APPLICATION INFORMATION
SO YOU CAN MAKE INFORMED
PURCHASING DECISIONS***

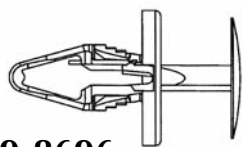
**99-8696**

Replaces: 11589289, W713610-S300,
6508863AA

RIVET-DRIVE TYPE, Flares, Cowl,
RKR Moulding., Front Bumper, Plastic
Hole: M6.25-6.53, Flange: 18MM,
Stem Lgth: 17.5MM, P.R.: 2-4MM
G.M. Equinox & Torrent 2007,
Buick Enclave, Saturn '91/
Ford Focus 2008/ & Dodge PU 2009/
UNIT PACKAGE 25

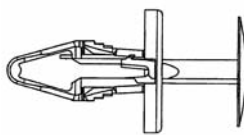
**99-8578**

Replaces: 11589290, W714040-S300

RIVET-DRIVE TYPE,
COWL VENT & BUMPER, Plastic
Hole: M6.25-6.53, Flange: 18MM,
Stem Lgth: 20MM, P.R.: 4.5-7.0
G.M. 'A' 'W', 'L', 'M', G5 Body 2005/
C/K Truck & SUV 2007/, Saturn Sky
2007/, Ford Flex 2009
UNIT PACKAGE 50

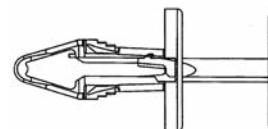
**99-8695**

Replaces: 11589291, W713331-S300

RIVET-DRIVE TYPE,
AIR DAM & GRILLE
Plastic
Hole: M6.25-6.53, Flange: 18MM,
Stem Lgth: 22MM, P.R.: 7-9.5MM
G.M. 2006/ & Ford
UNIT PACKAGE 25

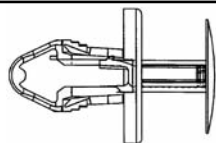
**99-8697**

Replaces: 15296830, 5116530AA

RIVET-DRIVE TYPE,
FLARES & PANELS
Plastic
Hole: M7.75-8.25, Flange: 19MM,
Stem Lgth: 16MM, P.R.: 5-7MM
G.M. & Dodge Caliber & Charger, Jeep
Patriot 2006/
UNIT PACKAGE 25

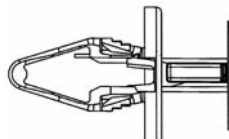
**99-8698**

Replaces: 11589292

RIVET-DRIVE TYPE,
AIR DAM, FENDER FLARES/APRON
Plastic
Hole: M8.25-8.53, Flange: 20MM,
Stem Lgth: 20MM, P.R.: 2-4.5MM
G.M. Full Size Pick Up & SUV 2006/
Cadillac Escalade 2007/
UNIT PACKAGE 25

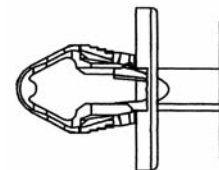
**99-8552**

Replaces: 11609417

RIVET-DRIVE TYPE, FENDER APRON
Plastic
Hole: M8.25-8.53, Flange: 19MM,
Stem Lgth: 14MM, P.R.: 2.7-5.3MM
G.M. Cobalt, G5 2005
Avalanche, Escalade & Acadia 2007/
UNIT PACKAGE 50

MOULDING CLIPS

UNIVERSAL

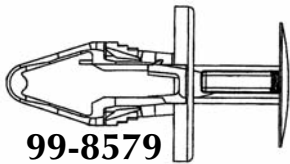

99-8579

Replaces: 11589293, W712196-S300
RIVET-DRIVE TYPE,
 COWL VENT, FENDER & BUMPER Plastic
 Hole: M8.25-8.53, Flange: 20MM,
 Stem Lgth: 21.5MM, P.R.: 4.5-7.0
 G.M. 'W', 'N' Body & Hummer 2005/
 Full Size SUV & Suburban 2007/
 Ford Edge/MKX 2007/, Flex 2009
 Fusion/MKZ/Zephyr/Milan2006/
 UNIT PACKAGE 25

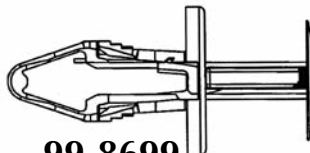

99-8699

Replaces: 11589294
RIVET-DRIVE TYPE,
 FENDERS & BUMPERS, Plastic
 Hole: M8.25-8.53, Flange: 20MM,
 Stem Lgth: 24MM, P.R.: 7.0-10MM
 Buick LaCrosse/Allure 2005/, Chevrolet
 Traverse 2009
 G.M. C/K Trucks, SUV's Hummer 2007/
 UNIT PACKAGE 25

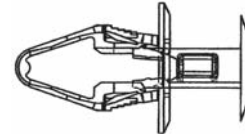

99-8580

Replaces: 11561368, 6508712AA
RIVET-DRIVE TYPE, FENDER,
 WHEEL & BUMPER
 Plastic
 Hole: M9.25-9.53, Flange: 18MM,
 Stem Lgth: 20MM, P.R.: 3.0-5.7MM
 G.M. 'W' & 'M' Body 2006,
 Jeep Wrangler 2006/
 UNIT PACKAGE 25

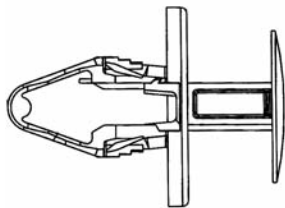

99-8700

Replaces: 11589295, 5GUU9K111BA,
 W712665-S300
RIVET-DRIVE TYPE,
 BUMPERS, FUEL TANK SHIELD, Plastic
 Hole: M10.25-10.53, Flange: 25MM,
 Stem Lgth: 20MM, P.R.: 3-6MM
 G.M. HHR, G5, G6 & C/K TRUCKS 2005/
 Saturn Vue 2008/, Saab 9-3 2008
 Chrysler & Ford
 UNIT PACKAGE 25

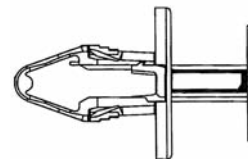

99-8701

Replaces: 11589296
RIVET-DRIVE TYPE,
 FENDER APRON
 Plastic
 Hole: M10.25-10.53, Flange: 25MM,
 Stem Lgth: 23MM, P.R.: 6.0-9MM
 G.M. 2007/
 UNIT PACKAGE 25

USE THE SIZE CHART FOR UNIVERSAL APPLICATIONS

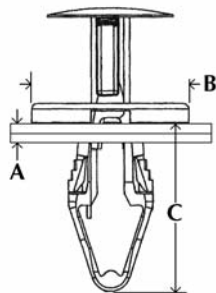

C-P #	HOLE	A PANEL RANGE	B FLANGE	C STEM LENGTH
99-8696	M6.25-6.53	2.0-4.5MM	18.0MM	17.5MM
99-8578	M6.25-6.53	4.5-7.0MM	18.0MM	20.0MM
99-8695	M6.25-6.53	7.0-9.5MM	18.0MM	22.0MM
99-8697	M7.75-8.03	5.0-7.0MM	19.0MM	16.0MM
99-8698	M8.25-8.53	2.0-4.5MM	20.0MM	20.0MM
99-8552	M8.25-8.53	2.7-5.3MM	19.0MM	14.0MM
99-8579	M8.25-8.53	4.5-7.0MM	20.0MM	21.5MM
99-8699	M8.25-8.53	7.0-10.0MM	20.0MM	24.0MM
99-8580	M9.25-9.53	2.95-5.75MM	18.0MM	20.0MM
99-8700	M10.25-10.53	3.0-6.0MM	25.0MM	20.0MM
99-8701	M10.25-10.53	6.0-9.0MM	25.0MM	23.0MM



83-5739
RIVET-DRIVE TYPE
 Hole: 1/4", P.R.: .020 - .174
 Plastic
 General Usage
 UNIT PACKAGE 100

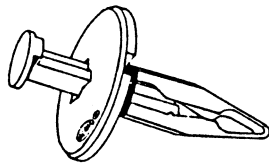

86-6095
 Replaces: N804674-S
RIVET-DRIVE TYPE
 Hole: M7,
 Washer: 25MM, G.R.: 12 - 15MM
 Black Plastic
 Ford Mustang, Capri
 UNIT PACKAGE 50

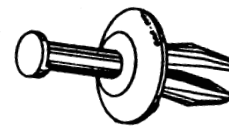

86-6085
 Replaces: 14071289
RIVET-DRIVE TYPE
 VARIOUS APPLICATIONS
 Hole: M8, Washer: 17MM,
 P.R.: 2.0 - 6.0MM
 Black Plastic
 G.M.
 UNIT PACKAGE 50



75-4127
RIVET-DRIVE TYPE
 Hole: 3/16"
 Plastic
 General Purpose
 UNIT PACKAGE 100

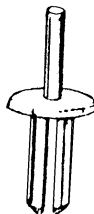

84-5875
RIVET-DRIVE TYPE
 Hole: 7/32", Head: 3/8"
 P.R.: 3/32" -5/16"
 Plastic
 General Purpose
 UNIT PACKAGE 50



72-2080
**PLASTIC PLUG FOR BLIND
 MOULDING BOLT INSTALLATION**
 Hole: 5/16", No. 8 Screw
 Specially Designed for Narrow
 Mouldings. Splits Into 4 Equal Sections to
 Make a Positive 360 Locking Action.
 All Cars & Models
 UNIT PACKAGE 100

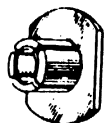

65-2026
**PLASTIC PLUG FOR BLIND
 MOULDING BOLT
 INSTALLATION**
 Hole: 5/16",
 #10 Screw
 Splits Into 4 Equal Sections
 to Make a Positive
 360 Locking Action. Cannot
 Slip Out of an Oblong Hole.
 UNIT PACKAGE 100



72-2078
**PLASTIC PLUG FOR BLIND
 MOULDING-5/16" Hole**
 No. 10 Screw.
 Specially Designed
 for Narrow Mouldings.
 Splits Into 4 Equal Sections
 to Make a Positive
 360 Degree Locking Action.
 All Cars & Models
 UNIT PACKAGE 100

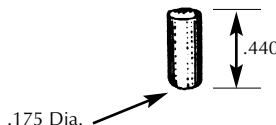

72-2081
**NYLON PLUG FOR BLIND
 MOULDING-ALL RIVET TYPE**
 Chrysler, American Motors,
 Ford Products
 (For Use When
 Pin Is Driven Out)
 UNIT PACKAGE 100

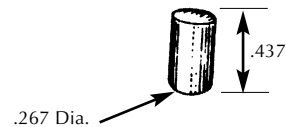

72-2082
**NYLON PLUG FOR BLIND
 MOULDING-ALL RIVET TYPE**
 Chrysler, American Motors,
 Ford Products
 (For Use When
 Pin Is Driven Out)
 All Cars & Models
 UNIT PACKAGE 100

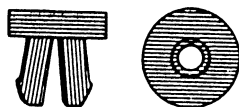

J01237
 Replaces: 3783006
GROMMET
 For #8-10 Screw 9/32" Hole
 Chevrolet & General Purpose
 UNIT PACKAGE 100

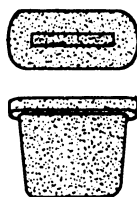

J01702
 Replaces: 6276604
PLUG-TRIM PANEL
 G.M.
 UNIT PACKAGE 50

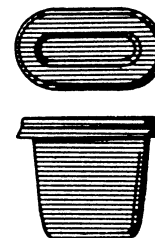

J02146
 Replaces: 4459049
PLUG-TRIM PANEL
 G.M.
 UNIT PACKAGE 50



88-6380

RETAINER-PUSH IN TYPE
 Hole: 3/16", G.R.: 1/8 - 5/16"
 Head: 7/16"
 White Plastic
 General Purpose
 UNIT PACKAGE 50



88-6381

RETAINER-PUSH IN TYPE
 Hole: 5/32", G.R.: 1/8 - 3/8"
 Head: 7/16"
 Natural Plastic
 General Purpose
 UNIT PACKAGE 50

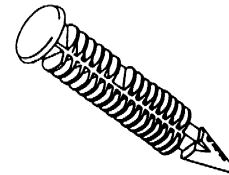

93-7146

RETAINER-BUMPER COVER & GENERAL PURPOSE
 Hole: 1/4", Head: 13/32"
 Stem Length: 1-11/32"
 Plastic
 Postal Vehicles
 UNIT PACKAGE 50

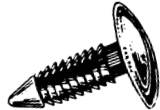

POPULAR TREE RETAINERS FOR 1/4" (M6.35) HOLES AND 3/4" (17.8MM) HEADS



C-P #	COLOR	HOLE	HEAD	O/L	PANLRANGE	UNIT PKG.
98-7887	BLACK	M6.3 (1/4)	17.8MM	16.0MM	3.0-8.0MM	25
72-3704	BLACK	M6.3 (1/4)	17.8MM	18.0MM	3.0-10.0MM	100
71-3499	GREY	M6.3 (1/4)	17.8MM	18.0MM	3.0-10.0MM	100
76-4384	BLACK	M6.3 (1/4)	17.8MM	23.0MM	2.0-13.5MM	100
99-8054	MATTE BLACK	M6.3 (1/4)	17.8MM	23.0MM	2.0-13.5MM	50
J06555	GREY	M6.3 (1/4)	17.8MM	23.0MM	2.0-13.5MM	50
99-7977	LT. GRAPHITE	M6.3 (1/4)	17.8MM	23.0MM	2.0-13.5MM	50
99-7978	LT. PRARIE TAN	M6.3 (1/4)	17.8MM	23.0MM	2.0-13.5MM	50
99-7979	CHARCOAL	M6.3 (1/4)	17.8MM	23.0MM	2.0-13.5MM	50
99-7980	WHITE PEARL	M6.3 (1/4)	17.8MM	23.0MM	2.0-13.5MM	50
95-7387	BLACK	M6.3 (1/4)	17.8MM	29.0MM	2.8-20.0MM	50
99-8413	BLACK-TEXTURED	M6.3 (1/4)	17.8MM	36.0MM	2.0-22.0MM	25
96-7588	BLACK	M6.3 (1/4)	17.8MM	37.0MM	10.0-28.0MM	50
98-7881	BLACK-TEXTURED	M6.3 (1/4)	17.8MM	48.0MM	3.0-39.5MM	25

PAINTLESS DENT REPAIR HOLE PLUGS

99-8584

HOLE PLUG
 Plastic-Black

Hole: 1/8, Head: 13/64,
 P.R.: 0.031-0.094

Use for Paint-less Dent Repair & General Use
 UNIT PACKAGE 100



99-8585

HOLE PLUG
 Plastic-Black

Hole: 3/16, Head: 11/32,
 P.R.: 0.031-0.140

Use for Paint-less Dent Repair & General Use
 UNIT PACKAGE 100

ADDITIONAL HOLE PLUGS FOR DENT REPAIR

PLASTIC HOLE PLUGS FLUSH STYLE
 (Black) General Purpose

CAR-PAK #	HOLE SIZE	PANEL RANGE	UNIT PKG.
84-5872	3/8"	0.060-0.125	100
95-7448	1/2"	0.060-0.090	100
95-7449	5/8"	0.060-0.100	100
95-7450	11/16"	0.060-0.094	100
95-7451	3/4"	0.060-0.090	100
95-7452	7/8"	0.060-0.090	100
92-7064	1"	0.060-0.094	50

PLASTIC HOLE PLUGS RECESSED STYLE
 FOR 14 TO 16 GAGE MATERIAL

CAR-PAK #	HOLE SIZE	UNIT PKG.
76-4379	1/2"	100
92-7063	3/4"	50
J06624	7/8"	100
J06625	1"	100
J06626	1-1/4"	50
J06627	1-1/2"	50
79-5015	1-5/8"	50
J06628	2"	50

NYLON PUSH-IN FASTENERS

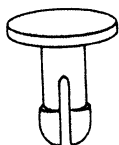

RATCHET RIVETS

CAR-PAK #	HOLE SIZE	PANEL RANGE	HEAD DIA	UNIT PKG
J05794	1/8"	1/8"	13/64"	100
J05795	1/8"	1/4"	13/64"	100
J05796	3/16"	1/16"	11/32"	100
J05797	3/16"	1/8"	11/32"	100
J05798	3/16"	1/4"	11/32"	100
J05799	1/4"	3/16"	19/32"	100
J05800	1/4"	1/4"	19/32"	100
J05801	1/4"	3/8"	19/32"	100
J05802	1/4"	1/2"	19/32"	100

Two mating parts that securely connect flat panels.
Ideal for both rigid and compressible materials.

Material: Nylon 6 6

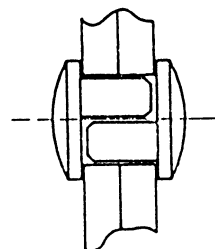

CAR-PAK #	HOLE DIA	PANEL RANGE	HEAD DIA / THK	UNIT PKG
J06446	.276-.281	.235 - .297	.750 / .093	100 (50 sets)
J06447	.276-.281	.346 - .500	.750 / .093	100 (50 sets)
J06448	.276-.281	.500 - .812	.750 / .093	100 (50 sets)
J06449	.276-.281	.235 - .297	.406 / .062	100 (50 sets)
J06450	.276-.281	.346 - .500	.406 / .042	100 (50 sets)
J06451	.276-.281	.500 - .812	.406 / .062	100 (50 sets)

TRUCK PRODUCTS

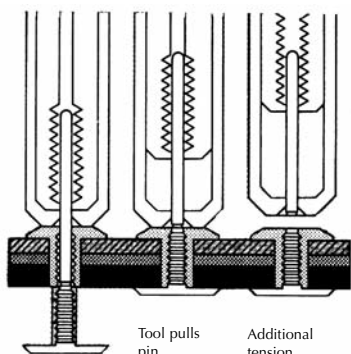

Pin and body are inserted from opposite sides of panel

Tool pulls pin through body and panel until head is flush against body against body stop

Additional tension causes pin to break off

Provides a Flange on Both Sides for a Finished Appearance

99-8001

Replaces: 15738538, 15738539
RIVET-SANDWICH TYPE
Plastic - Side Door Weatherstrip
Hole: M5, Head: 12 x 22MM, PR.: 10MM
G.M. C/K Trucks '96/
UNIT PACKAGE 15

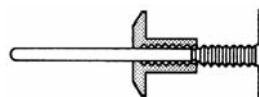

97-7689

Not Supplied By O.E.
RIVET- SANDWICH TYPE
INTERIOR PANELS
Plastic
Hole Dia: M5, Panel Thickness: 6MM
Various Trucks & General Purpose
UNIT PACKAGE 15

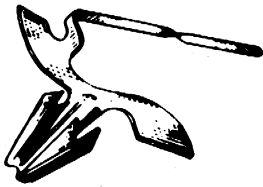

67-3083

Replaces: 6003331
RETAINER-MOULDING
 (For 1-3/16" Moulding)
 General Purpose
UNIT PACKAGE 50

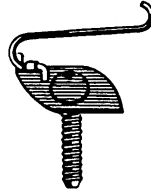

98-7815

Not Supplied By O.E.
CLIP-T-BOLT TYPE for MOULDINGS
 (Formerly 66-1175)
 Bolt: 10-24 X 3/4" Plate: 5/16 X 3/4"
 G.M. Cars & General Purpose
UNIT PACKAGE 25



99-8205

Replaces: 6002056
CLIP-T-BOLT TYPE W/SEALER
 Formerly 77-4533
 Bolt: 10-24 x 3/4", Plate: 5/16 x 3/4"
 Chrysler Products & General Purpose
UNIT PACKAGE 15



99-8064

T-BOLT-UNIVERSAL
 10-24 x 5/8" Bolt, Plate: 1/2 x 1"
UNIT PACKAGE 25

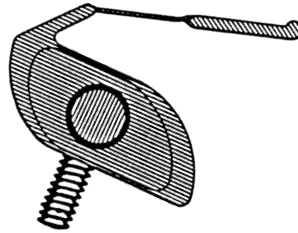

J02165

CLIP-MOULDING
 10-24 x 9/16" Stud
 Universal
UNIT PACKAGE 50

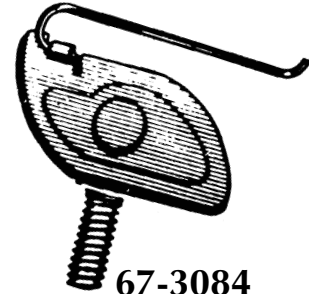

67-3084

T-BOLT-BOLT MOULDING
 10 - 24 x 5/8", PLATE: 19/32x1-1/4"
 Ford, Chrysler, G.M. &
 General Purpose
UNIT PACKAGE 50

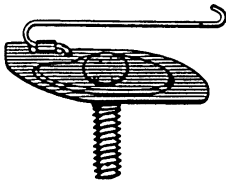

98-7816

Not Supplied By O.E.
CLIP- T-BOLT TYPE for MOULDINGS
 (Formerly 66-3066)
 Bolt: 10-24 X 3/4" Plate: 1/2 X 1-7/16"
 General Purpose
UNIT PACKAGE 25

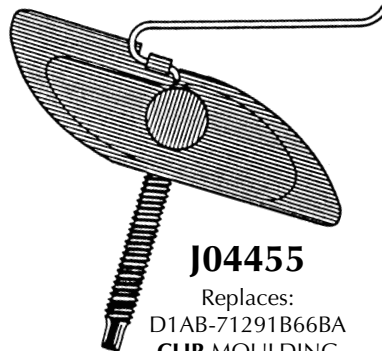

J04455

Replaces:
 D1AB-71291B66BA
CLIP-MOULDING
 8-32 x 1" Stud
 Ford & General Purpose
UNIT PACKAGE 50

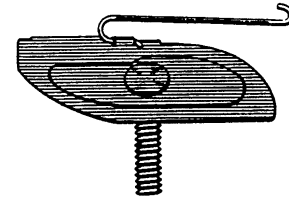

98-7817

Not Supplied By O.E.
CLIP- T-BOLT TYPE for MOULDINGS
 (Formerly 71-3457)
 Bolt: 10-24 X 3/4" Plate: 5/8 X 1-7/8"
 General Purpose
UNIT PACKAGE 25

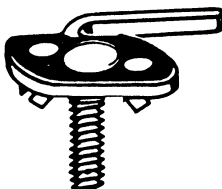

J05814

Replaces: 973112
CLIP-MOULDING
 10-24 x 3/4" Stud
 Nylon & Steel
 A.M.C. & Universal
UNIT PACKAGE 25

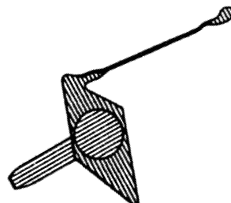

99-8365

Not Supplied By O.E.
CLIP-T-BOLT TYPE FOR MOULDINGS
 Use w/Barrel Nuts
 Stud: 1/8x1/2" w/Seal
 Formerly J03881
UNIT PACKAGE 15

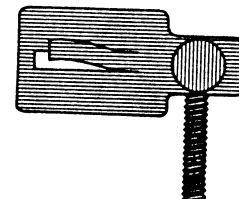

J04458

Replaces: C8MB-5420844C
T-BOLT
 8-32 x 9/16" Stud
 Ford Products
UNIT PACKAGE 25

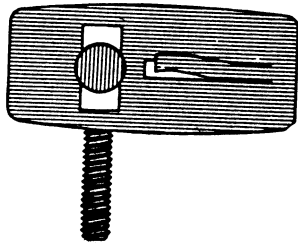

J04457

Replaces: D2OB-65517B76AB
T-BOLT
 8-32 x 5/8" Stud
 Ford Products
 UNIT PACKAGE 25

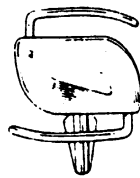

64-1011

PLASTIC MOULDING CLIP ASSEMBLY
 Low Profile to Accomodate Shallow
 Mouldings (No Hand Grinding Required)
 23/32" x 1-5/16"
 General Purpose
 UNIT PACKAGE 100

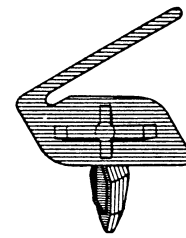

J05216

CLIP-PUSH-IN TYPE MOULDING
 Black Plastic
 General Purpose
 UNIT PACKAGE 50

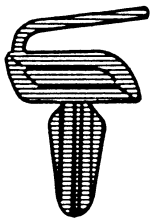

J01995

CLIP-NYLON PUSH-IN TYPE
 MOULDING
 General Purpose
 UNIT PACKAGE 50

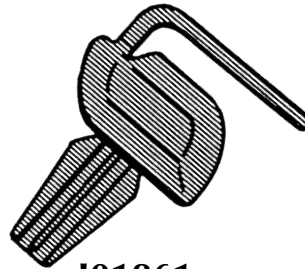

J01861

Replaces: 4877000
CLIP-PUSH-IN TYPE
 FOR THICK MOULDINGS
 G.M. & General Purpose
 UNIT PACKAGE 50

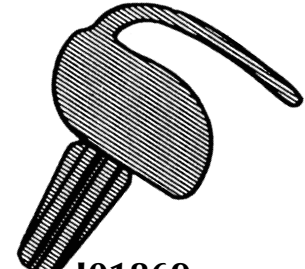

J01869

Replaces: 4853108
CLIP-PUSH-IN TYPE
 FOR THIN MOULDINGS
 G.M. & General Purpose
 UNIT PACKAGE 50

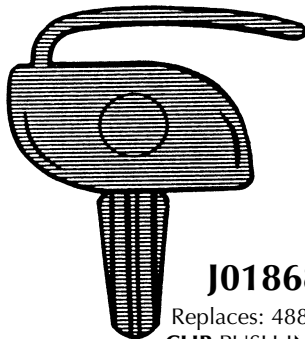

J01868

Replaces: 4883164
CLIP-PUSH-IN TYPE
 FOR THIN MOULDINGS
 G.M. & General Purpose
 UNIT PACKAGE 50

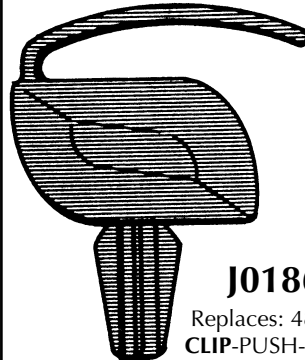

J01862

Replaces: 4877001
CLIP-PUSH-IN TYPE
 FOR THICK MOULDINGS
 G.M. & General Purpose
 UNIT PACKAGE 50

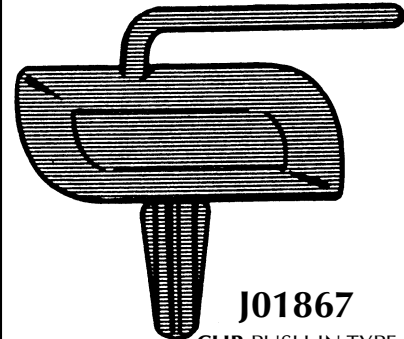

J01867

CLIP-PUSH-IN TYPE
 FOR THICK MOULDINGS
 G.M. & General Purpose
 UNIT PACKAGE 25

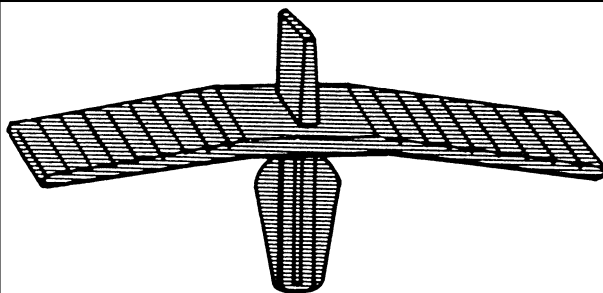

J01972

CLIP-BREAK-OFF TYPE FOR
 MOULDINGS UP TO 3" WIDE
 General Purpose
 UNIT PACKAGE 25

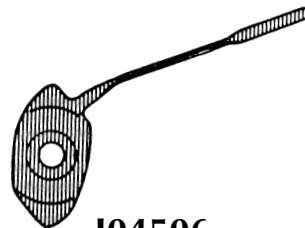

J04506

Replaces: 7636662
CLIP-DOOR MOULDING
 #8-32 Screw
 Steel
 G.M., Chrysler & General Purpose
 UNIT PACKAGE 50

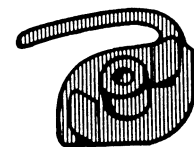

J01897

Replaces: 4886720
CLIP-DOOR MOULDING
 G.M. & General Purpose
 UNIT PACKAGE 50

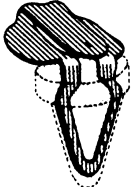

J02276
RETAINER-TRIM PANEL
 Universal
 UNIT PACKAGE 100

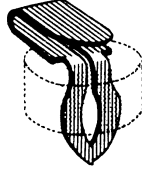

J02277
RETAINER-TRIM PANEL w/SEALER
 Universal
 UNIT PACKAGE 100

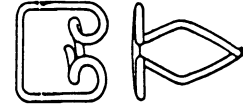

J05179
CLIP-TRIM
 1/2" x 1/2"
 UNIT PACKAGE 100



J04463
CLIP-TRIM
 UNIT PACKAGE 100

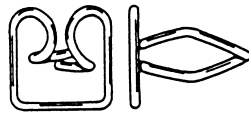

J01157
CLIP-TRIM
 5/8" x 5/8"
 UNIT PACKAGE 50

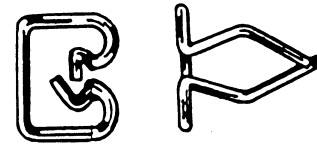

J02164
CLIP-TRIM
 11/16" x 9/16"
 UNIT PACKAGE 100

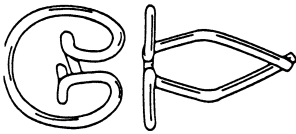

J04307
CLIP-TRIM
 3/4"
 UNIT PACKAGE 100

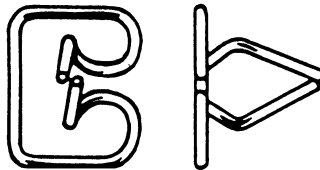

J01986
CLIP-TRIM
 3/4" x 15/16"
 UNIT PACKAGE 100

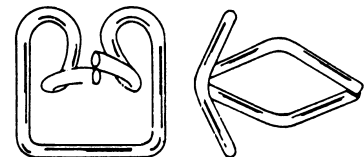

J04462
CLIP-TRIM
 7/8" x 7/8"
 UNIT PACKAGE 50

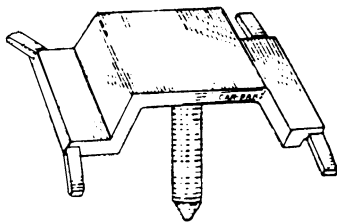

79-5066
 Not Supplied By O.E.
RETAINER-SUNROOF MOULDINGS
 General Usage on Sunroof Installations
 UNIT PACKAGE 25



79-5019
 Replaces: 6002056
CLIP-BELT MOULDING
 Plastic
 Used on Vinyl Tops
 All Cars
 UNIT PACKAGE 100



J00923
HOG RING-UPHOLSTERY & SEAT COVER RING
 UNIT PACKAGE 500

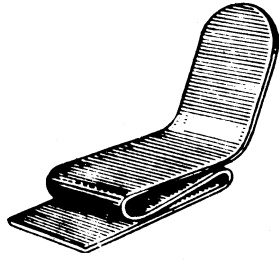

69-3304

Replaces: 9787809
CLIP-DASH PANEL PADDING
 G.M. Full Size Cars '70
UNIT PACKAGE 50

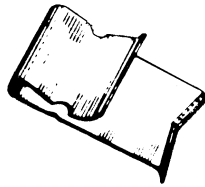

70-3395

Replaces: 8738860
CLIP-COWL CENTER DUST
AIR OUTLET DRIVE, LEFT
HAND
 G.M. Full Size Cars '70 - '71
UNIT PACKAGE 50

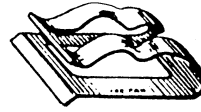

76-4284

Replaces: 487909
CLIP-DASH PAD
 Pontiac '75/
UNIT PACKAGE 100

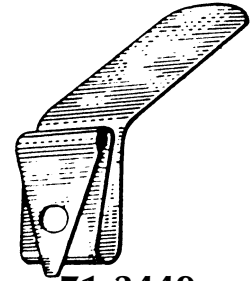

71-3449

Replaces: 3984466
CLIP-INSTRUMENT PANEL
PAD
 Chevrolet '71/
UNIT PACKAGE 50

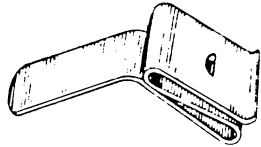

70-3427

Replaces: D1AZ-6504278-A
CLIP-DASH PANEL PADDING
 Ford '71
UNIT PACKAGE 100

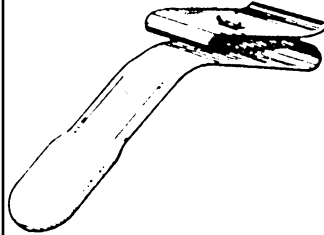

77-4706

Replaces: 387492-S2
CLIP-DASH PANEL PADDING
 Ford '76/
UNIT PACKAGE 100



72-3729

Replaces: 2521729
CLIP-A/C DUCTS
 Chrysler '69 - '73
UNIT PACKAGE 50



72-3727

Replaces: 2837285
CLIP-A/C DUCTS
 Chrysler '69 - '73
UNIT PACKAGE 50

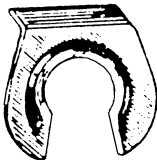

69-3259

Replaces: 7783546
CLIP-COWL AIR OUTLET
CONTROL
 Chevrolet, Buick, Pontiac, Olds
 Cadillac '68 - '72
UNIT PACKAGE 50

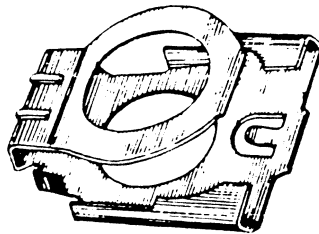

71-3441

Replaces: 9876579
CLIP-TAIL GATE CHANNEL
ASSEMBLY
 Anti-Rattle
 G.M. Station Wagons '71 - '72
UNIT PACKAGE 25

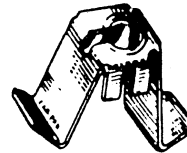

76-4292

Replaces: 6030981
NUT-FRONT SEAT
QUARTER HINGE
 Chrysler '76/
UNIT PACKAGE 100

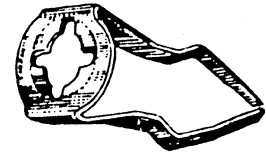

76-4377

Replaces: 386773-S100
CLIP-DASH PAD TO
INSTRUMENT PANEL
 Ford
UNIT PACKAGE 100



74-4073

Replaces: 414638
CLIP-CLOCK TO STUD
 Olds '74/
UNIT PACKAGE 100

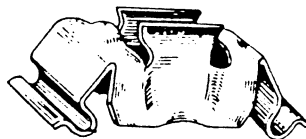

72-3722

Replaces: 1385468
CLIP-INSTRUMENT PANEL
COVER TO PANEL OUTER
ENDS
 Buick, Pontiac '70 - '73
UNIT PACKAGE 50

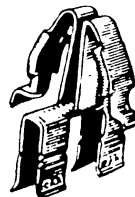

72-3633

Replaces: 489003, 488805
CLIP-DASH PAD TO
INSTRUMENT PANEL
 Pontiac '71 - '73
UNIT PACKAGE 100

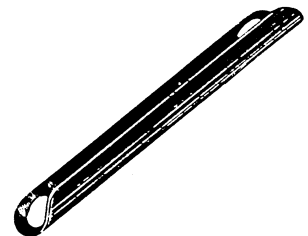

72-3717

Replaces: 406576
SPRING-ASH TRAY DOOR
 F-85 Olds '70 - '72
UNIT PACKAGE 50

**'C' Tree
Fastener Charts
Part No.
X-CT-CH**

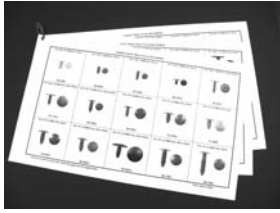

**** Car-Pak's 'NEW' 'C' Tree fastener identification chart.
Easy to 'C' & Easy to 'ID'
'C' the Size by Comparison
'C' the Type
'C' Charts!**

- ** This 6 page chart has 88 Popular Tree fasteners sorted by head style, hole diameter and stem length.**
 - ** All fasteners have actual size photos in both top and side view for easy identification.**
 - ** The charts sized at 8-1/2 x 14" printed both sides make it easy to transport and will not take up valuable wall space in the shop.**
 - ** The charts are packaged 3 sets per unit.**
- The 'C' charts will prove to be a great tool for both salesman and your customers.**

**'C' Rivet
Fastener Charts
Part No.
X-RV-CH**

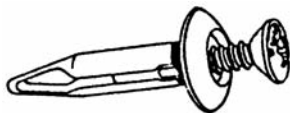
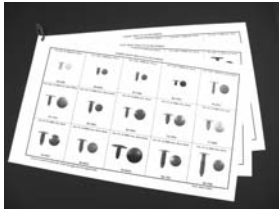

**** Car-Pak's 'NEW' 'C' Rivet fastener identification chart.
Easy to 'C' & Easy to 'ID'
'C' the Size by Comparison
'C' the Type
'C' Charts!**

- ** This 6 page chart has 90 Popular Rivet fasteners sorted by Drive style, hole diameter and stem length.**
 - ** All fasteners have actual size photos in both top and side view for easy identification.**
 - ** The charts sized at 8-1/2 x 14" printed both sides make it easy to transport and will not take up valuable wall space in the shop.**
 - ** The charts are packaged 3 sets per unit.**
- The 'C' charts will prove to be a great tool for both salesman and your customers.**

**'C' Trim
Fastener Charts
Part No.
X-NT-CH**

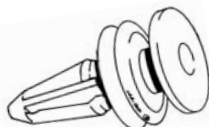
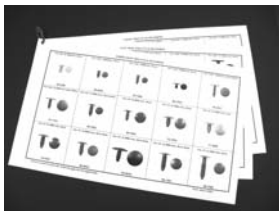

**** Car-Pak's 'NEW' 'C' Trim fastener identification chart.
Easy to 'C' & Easy to 'ID'
'C' the Size by Comparison
'C' the Type
'C' Charts!**

- ** This 6 page chart has 82 Popular Trim fasteners sorted by Head style, hole diameter and stem length.**
 - ** All fasteners have actual size photos in both top and side view for easy identification.**
 - ** The charts sized at 8-1/2 x 14" printed both sides make it easy to transport and will not take up valuable wall space in the shop.**
 - ** The charts are packaged 3 sets per unit.**
- The 'C' charts will prove to be a great tool for both salesman and your customers.**